**TECHNICAL CATALOGUE
2021**



Legal Information System design / dimension data

This document contains only general, technical information. The design of HELIROMA products, especially the dimensions, must be drawn up and calculated separately for each specific individual application.

Always observe the applicable national and international regulation, laws, standards and guidelines.

Areas of application not contained in this document require consultation with our Technical Department.

Disclaimer

All information contained in this document, which is based on or which refers to standards, ordinances or regulations, has been thoroughly researched and carefully compiled with the to the best of our knowledge. However, we cannot guarantee that such information is correct, complete or up to date, we accept no liability for the same. HELIROMA reserves the right to make technical amendments.

Further product information

Further product information is available at www.heliroma.pt

Copyright

This work and all its parts are protected by copyright. Any use outside of that permitted by the Copyright Act is not allowed without the approval of HELIROMA local unit. We reserve the right, in particular, to reproduce, reprint, edit, store and process in electronic systems, translations and microfilming.

Update Technical Information

Check regularly whether the Technical Information which you have is available in a latest version. The date of issue of your Technical Information is always printed on the bottom left of the cover.

General safety precautions

- Only allow authorised and trained persons to install HELIROMA systems.

- If the operating parameters are exceeded, the pipes and fittings may become overstrained. Not adhering to the operating parameters is thus not allowable.

Keeping within the operating parameters must be ensured by safety/control equipment.

Navigation

A detailed table of contents is included at the beginning of this Technical Catalogue with the hierarchical titles and the corresponding page numbers.

TABLE OF CONTENTS

0 CORPORATE	7		
CHRONOLOGY	8		
HISTORY	10		
MARKETS	12		
INNOVATION	12		
MISSION, VISION, VALUES	13		
QUALITY	14		
QUALITY CONTROL PROCESS	15		
QUALITY MANAGEMENT PROCESS	16		
CERTIFICATIONS	16		
SUSTAINABILITY	17		
1 PP-R	19		
PP-R SYSTEM	20		
PP-R 100 PP-R 100+FG PP-RCT125 + FG	20		
- Product Range Overview	21		
PP-R 100 - HELISYSTEM	22		
- PP-R 100	22		
- HELISYSTEM - PP-R 100 SDR 6 PP-R 100 SDR 7,4	22		
- Advantages and Key Features of HELISYSTEM	24		
- Applications	24		
- Pipe Marking	25		
- Dimensions and Flow Rate	26		
- Permissible Working Pressure	27		
PP-R 100 + FG - ROMAFASER & ROMA KLIMA	28		
- PP-R 100 with FIBERGLASS	28		
- ROMAFASER - PP-R 100 + FG SDR 7,4	29		
- ROMA KLIMA - PP-R 100 + FG SDR 11	29		
- Advantages and Key Features of ROMAFASER and ROMA KLIMA	30		
- Applications	30		
- Pipe Marking	31		
- Dimensions and Flow Rate	32		
- Permissible Working Pressure	33		
- ROMAFASER ANTI-UV - PP-R 100 + FG ANTI UV SDR 7,4	35		
- Advantages and Key Features of ROMAFASER ANTI-UV	35		
PP-RCT 125 + FG – ROMAFASER CT & ROMA KLIMA CT	36		
- PP-RCT 125 with FIBERGLASS	36		
- ROMAFASER CT - PP-RCT 125 + FG SDR 11	39		
- ROMA KLIMA CT - PP-RCT 125 + FG SDR 17	39		
- Advantages and Key Features of ROMAFASER CT and ROMA KLIMA CT	40		
- Applications	40		
- Pipe Marking	41		
- Dimensions And Flow Rate	42		
- Permissible Working Pressure	43		
INSTALLATION GUIDELINES	45		
GENERAL RECOMMENDATIONS	45		
DESIGNING GUIDELINES	45		
FIXING TECHNIQUES	45		
THERMAL EXPANSION	47		
- Support Intervals	47		
- Absorption Arms	47		
- Expansion Loop	48		
		- Expansion Loop - Pre-Tensioning	48
		INSULATION	49
		LEAKAGE TEST	49
		CHEMICAL RESISTANCE	50
		DISINFECTION	53
		- Chemical Disinfection – Drinking Water	53
		- Chemical Disinfection – System	54
		- Thermal Disinfection	54
		INTEGRATION OF OTHER SYSTEMS WITH HELIROMA PP-R SYSTEM	55
		TRANSPORT AND STORAGE	55
		WELDING TECHNOLOGY	56
		SOCKET WELDING WITH A HAND-HELD WELDING MACHINE	57
		SOCKET WELDING WITH A STATIONARY WELDING MACHINE	58
		BUTT WELDING PROCESS	59
		WELD-ON SADDLE	62
		SOCKET WELDING WITH AN ELECTRIC MACHINE	63
		FLANGED CONNECTIONS	64
		PIPE REPAIR WITH REPAIR PIN	64
		SYSTEM FEATURES	65
		APPLICATION – POTABLE WATER INSTALLATIONS	66
		APPLICATION – SPECIFIC ENGINEERING	66
		SOUND INSULATION	66
		CORROSION RESISTANCE	67
		FULL SYSTEM RANGE	67
		SUSTAINABILITY	67
		WARRANTY	67
		PERMISSIBLE WORKING PRESSURE	68
		SYSTEM GENERAL ADVANTAGES	72
		CERTIFICATIONS	74
		PRODUCT RANGE	75
		PP-R PIPES	76
		PP-R FITTINGS	84
		ELECTROFUSION FITTINGS	131
		FITTINGS FOR ELECTROFUSION	134
		PP-R TOOLS	139
		2 RED-FIRE	145
		RED FIRE SYSTEM	146
		RED FIRE PIPE AND FITTINGS	146
		- Product Range Overview	147
		RED FIRE SYSTEM	148
		- Reaction to Fire Classification	149
		- Advantages and Key Features of Red Fire	150
		- Application Areas	151
		- Fire Hydrants	151
		- Sprinklers	152
		- Permissible Working Pressure	153
		- Pipe Marking	153
		INSTALLATION GUIDELINES	154
		WELDING TECHNOLOGY	155
		SYSTEM GENERAL ADVANTAGES	156
		CERTIFICATIONS	158
		PRODUCT RANGE	159

RED FIRE PIPE	160	MULTILAYER PIPES	226
RED FIRE FITTINGS	162	PPSU FITTINGS	228
		KLIMAPRESS AND FLANGED FITTINGS	236
		MULTILAYER TOOLS	254
3 MULTILAYER	191	4 PE-Xa	257
MULTILAYER SYSTEM	192	PEXROMA PIPE	258
PE-RT/AL/PE-RT KLIMAPRESS PPSU KLIMAPRESS FLANGED FITTINGS	192	PE-Xa PE-Xa EVOH	258
- Product Range Overview	193	- Product Range Overview	259
MULTILAYER PIPE – HELIKLIMA	194	PE-Xa – PEXROMA	260
- Advantages and Key Features of HELIKLIMA	195	- Oxygen Barrier	262
- Pipe Marking	196	- Advantages and Key Features of PEXROMA	264
- Dimensions and Flow Rate	196	- Applications	265
FITTINGS	197	- Pipe Marking	265
- KLIMAPRESS PPSU	198	- Dimensions and Flow Rate	266
- KLIMAPRESS PPSU Advantages	198	INSTALLATION GUIDELINES	267
- KLIMAPRESS	199	GENERAL RECOMMENDATIONS	267
- KLIMAPRESS Advantages	199	DESIGNING GUIDELINES	267
- FLANGED FITTINGS	200	THERMAL EXPANSION	268
SYSTEM	201	BENDING	268
INSTALLATION GUIDELINES	202	KINKED PIPES	269
GENERAL RECOMMENDATIONS	202	CORROSION	270
DESIGNING GUIDELINES	202	INSULATION	270
FIXING TECHNIQUES	203	FREEZING	270
THERMAL EXPANSION	203	PIPE FEATURES	271
- Support Intervals	204	CHEMICAL RESISTANCE	271
- Deflection Arms	205	LEAKAGE TEST	272
MINIMUM DIMENSION FOR FITTINGS COMBINATION	206	- Leak Test with Compressed Air or Inert Gas	272
BENDING	206	- Leak Test with Water	272
CORROSION	207	TRANSPORT AND STORAGE	273
INSULATION	208	WARRANTY	273
OPERATION	208	PIPE GENERAL ADVANTAGES	274
LEAKAGE TEST	209	CERTIFICATIONS	275
- Leak Test with Compressed Air or Inert Gas	209	PRODUCT RANGE	277
- Leak Test with Water	209	PE-Xa PIPE	278
DISINFECTION	210	PE-Xa EVOH PIPE	279
- Chemical Disinfection – Drinking Water	210		
- Chemical Disinfection – System	211		
INTEGRATION OF OTHER SYSTEMS WITH HELIROMA MULTILAYER SYSTEM	212	5 PE-RT	281
TRANSPORT AND STORAGE	212	ROMAPLUS PIPE	282
ASSEMBLY TECHNIQUES	213	PE-RT PE-RT EVOH	282
INSTALLED TEMPERATURES	214	- Product Range Overview	283
BENDING	214	PE-RT – ROMAPLUS	282
FITTINGS ASSEMBLY	216	- Oxygen Barrier	286
- KLIMAPRESS Fittings	216	- Advantages and Key Features of ROMAPLUS	288
- Flanged Fittings	219	- Applications	288
SYSTEM FEATURES	220	- Pipe Marking	289
APPLICATION	220	- Dimensions And Flow Rate	289
FULL SYSTEM RANGE	220	INSTALLATION GUIDELINES	290
SUSTAINABILITY	221	GENERAL RECOMMENDATIONS	290
WARRANTY	221	DESIGNING GUIDELINES	290
SYSTEM GENERAL ADVANTAGES	222	THERMAL EXPANSION	290
CERTIFICATIONS	224	CORROSION	290
PRODUCT RANGE	225	FREEZING	290

BENDING	291
PIPE FEATURES	291
LEAKAGE TEST	292
- Leak Test with Compressed Air or Inert Gas	292
- Leak Test with Water	292
CHEMICAL RESISTANCE	293
TRANSPORT AND STORAGE	293
WARRANTY	293
PIPE GENERAL ADVANTAGES	294
CERTIFICATIONS	295
PRODUCT RANGE	297
PE-RT PIPE	298
PE-RT EVOH PIPE	299

6 ULTRA SILENT..... 301

ULTRA SILENT SYSTEM	302
ULTRA SILENT PIPE AND FITTINGS	302
- Product Range Overview	303
ULTRA SILENT SYSTEM	304
- Advantages and Key Features of ULTRA SILENT	306
- Applications	306
- Pipe Marking	307
- Fittings	308
- Fittings Marking	308
ACOUSTIC PERFORMANCE	309
- Ultra Silent™ Sound Pressure Levels Lsc,A EN 14366	310
CHEMICAL RESISTANCE	311
INSTALLATION GUIDELINES	314
GENERAL RECOMMENDATIONS	314
PREPARATION AND ASSEMBLY	314
FIXING TECHNIQUES	315
INSTALLATION EXAMPLE	316
INSTALLATION THROUGH CEILINGS, FLOORS AND WALLS	317
REPAIRS AND INSTALLATION	318
TRANSPORT AND STORAGE	319
SYSTEM FEATURES	320
SUSTAINABILITY	321
WARRANTY	321
ULTRA SILENT™ FITTINGS	322
- Acoustic Clamp™	322
- Pressure Clamp™	322
- End Lock™	323
- Lock Seal™	324
- Ultra Seal™	325
SYSTEM GENERAL ADVANTAGES	326
CERTIFICATIONS	328
PRODUCT RANGE	328
ULTRA SILENT PIPES	330
ULTRA SILENT FITTINGS	335

BIM 351

I ANNEXES 353

ANNEX A: THERMAL EXPANSION	354
PP-R 100 SDR 6 & SDR 7,4 HELISYSTEM	354
PP-R 100 + FG SDR 7,4 & SDR 11 ROMAFASER & ROMAKLIMA	355
PP-RCT 125 + FG SDR 11 & SDR 17 ROMAFASER CT & ROMAKLIMA CT	355
PE-RT / AL / PE-RT HELIKLIMA	359
PE-Xa PEXROMA	357
PE-Xa EVOH PEXROMA EVOH	357
PE-RT ROMAPLUS	358
PE-RT EVOH ROMAPLUS EVOH	358
ANNEX B: SUPPORT INTERVALS	359
PP-R 100 SDR 6 & SDR 7,4 HELISYSTEM	359
PP-R 100 + FG SDR 7,4 & SDR 11 ROMAFASER & ROMAKLIMA & RED FIRE	359
PP-RCT 125 + FG SDR 11 & SDR 17 ROMAFASER CT & ROMAKLIMA CT	360
ANNEX C: PRESSURE LOSS	361
PP-R FITTINGS	361
PP-R 100 SDR 6 HELISYSTEM	362
PP-R 100 SDR 7,4 HELISYSTEM	368
PP-R 100 + FG SDR 7,4 ROMAFASER	368
PP-R 100 + FG SDR 11 ROMAKLIMA	376
PP-RCT 125 + FG SDR 11 ROMAFASER CT	376
PP-RCT 125 + FG SDR 17 ROMAKLIMA CT	384
PE-RT / AL / PE-RT HELIKLIMA	392
PE-Xa PEXROMA	395
PE-Xa EVOH PEXROMA EVOH	395
PE-RT ROMAPLUS	396
PE-RT EVOH ROMAPLUS EVOH	396
ANNEX D: LEAKAGE TEST	397
LEAK TEST WATER	397
LEAK TEST COMPRESSED AIR OR INERT GAS	398
ANNEX E: GENERAL SALES CONDITIONS	399





CORPORATE 0

CHRONOLOGY

HISTORY

MARKETS

INNOVATION

MISSION, VISION AND VALUES

QUALITY

QUALITY CONTROL PROCESS

QUALITY MANAGEMENT POLICY

CERTIFICATIONS

SUSTAINABILITY

**Foundation of HELIROMA-Plásticos S.A., in
Arrifana - Portugal**

First production of high and low
density polyethylene pipes

1996

1998

Move of facilities to
Albergaria-a-Velha

Market launch of PP-R
pipes and fittings

2001

2004

Market launch of PP-R +
FG larger diameters up
to 160 mm

Market launch of
PE-RT / AL / PE-RT multilayer
pipe and brass fittings

2007

2009

Move to new facilities with a
bigger area

Market launch of PE-Xa
pipes

2010



HELIROMA develops and produces high-performance plastic pipe systems for multiple applications.

HELIROMA complies with the highest market quality standards ensuring the safety, reliability, longevity, recycling, sustainability and first-class service of its pipe systems.

CHRONOLOGY

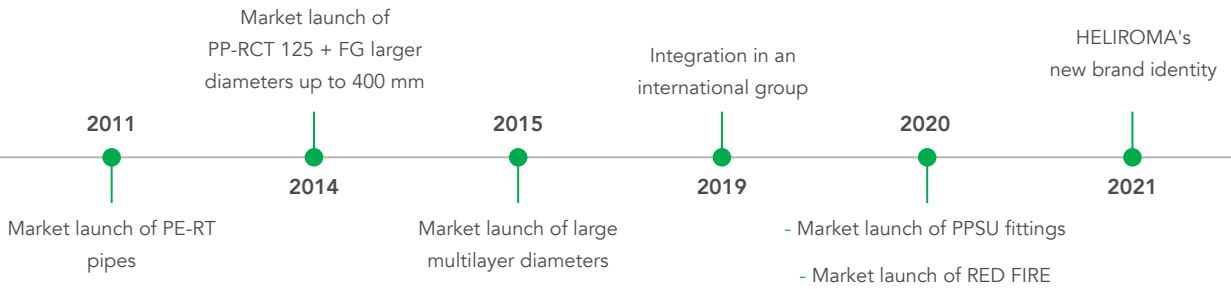

HISTORY



The history of HELIROMA begins in 1996 at Arrifana with the production of high and low-density polyethylene pipes for construction and agricultural sector.

Since an early age, HELIROMA shows their innovative nature, the company's strong position in the market, the powerful development and the increased competition makes HELIROMA expand its product range and move our facilities to a larger building.

HELIROMA also invested in the production of plumbing systems for hot-cold water and heating. This change stimulated the increase of highly qualified human resources resulting in a better quality of the products, turning HELIROMA into a reference in Europe, especially in the Iberian Peninsula, for the manufacture of PP-R pipes and fittings.

HELIROMA stands out as one of the few European manufacturers that produces PP-R pipes with fiberglass compound, also known as the third-generation pipe. This reality allowed to win a very significant share of the European market, and to produce these pipes for many of the world-renowned manufacturers.

HELIROMA is also one of the few Iberian manufacturers of multilayer pipes PE-RT / AL / PE-RT and fittings.

In addition, HELIROMA manufactures cross-linked polyethylene: PE-Xa pipes and a polyethylene raised temperature: PE-RT pipes with and without oxygen barriers.

At 2020, in COVID crisis, HELIROMA handled the launch of two new products: PPSU fittings, to complete a multilayer system and RED FIRE pipe and fittings, a system designed for the installation of sprinklers and hydrants on firefighting facilities.

With the best raw material, we produce PP-R 100, PP-RCT 125, PPSU, PE-Xa and PE-RT piping systems, offering to all customers a dimension bandwidth of 12-400 mm.

All HELIROMA's products are manufactured using most advance technology whether on extrusion and injection, in line with the most stringent international standards requirements.

At 2021, HELIROMA established a new brand identity. We believe that our brand now has a stronger presence, maintaining the link to the previous identity, and projecting HELIROMA in the future.

A wealth of ideas in product development and business skills, helped the company to achieve fast and healthy growth.

Today, HELIROMA is positioned as a technological pioneer in the industry.



MARKETS

HELIROMA aim for a long-term cooperation in partnership with our customers. The declared aim of this is to serve them in an optimum manner, with respect to reliability and quality products.

HELIROMA is proud of the long-standing trusting partnerships and the strong international network of customers and be present in 4 continents, more than 30 countries.

From Portugal, to the whole world. HELIROMA will always continue to innovate and develop, and bring new products to the market place.



INNOVATION

The HELIROMA's world does not stand still. HELIROMA always been looking ahead and innovating. Innovative products, optimised for the respective application are the requirement for installations in pressure applications.

We place particular emphasis on the quality and efficiency of our research and development.

MISSION, VISION AND VALUES



MISSION

To offer quality products and excellent services to its customers, providing added value, comfort and reliability to end consumer.



VISION

To become a unique reference on the national and international markets, consolidating long-lasting relationships with clients, suppliers and employees.



VALUES

- Respect, team's training and progress;
- Ethics
- Professionalism;
- Responsibility;
- Excellent customer service;
- Credibility and security;
- Cost effectiveness;
- Sustainability.

QUALITY



Quality continues to be the pillar of HELIROMA's success.

Through the fulfilment of our customers' quality standards and requirements, we ensure their satisfaction with our products and services.

HELIROMA apply quality standards and working guidelines that are valid and recognised worldwide.

HELIROMA invests heavily in the areas of Quality, Personnel Training, as well as in the Certification of the company and its products. We are certified according to EN ISO 9001:2015 by AENOR and IQNET. The high-quality standard allows a 10-year warranty on all products that we manufacture.

All HELIROMA's products passes through a demanding and rigorous analysis and respective production tests, in order to guarantee the product conformity. To complete analyses several tests are carried out in third party laboratories with international recognition.

Being certified with several product approvals means that we are visited many times a year from each certification Institute, and that production is constantly monitored.

This success is another step towards strengthening our competitive position at market.



QUALITY CONTROL PROCESS

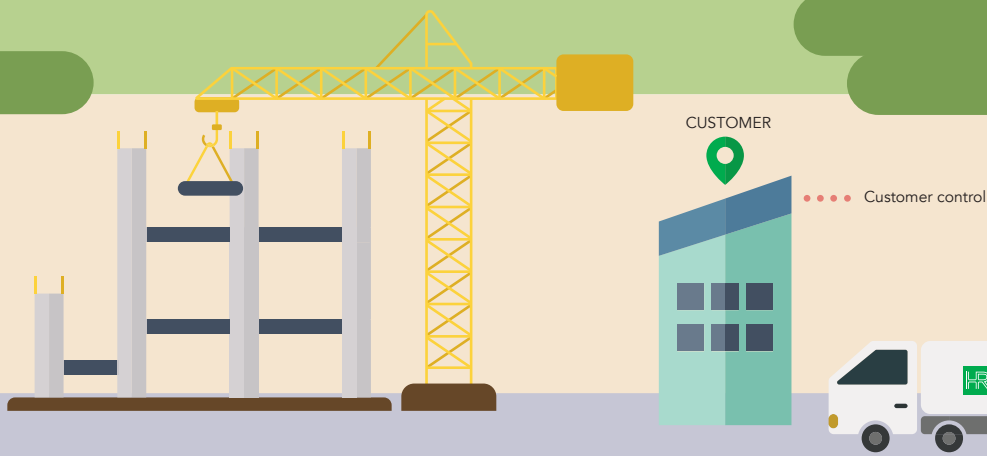
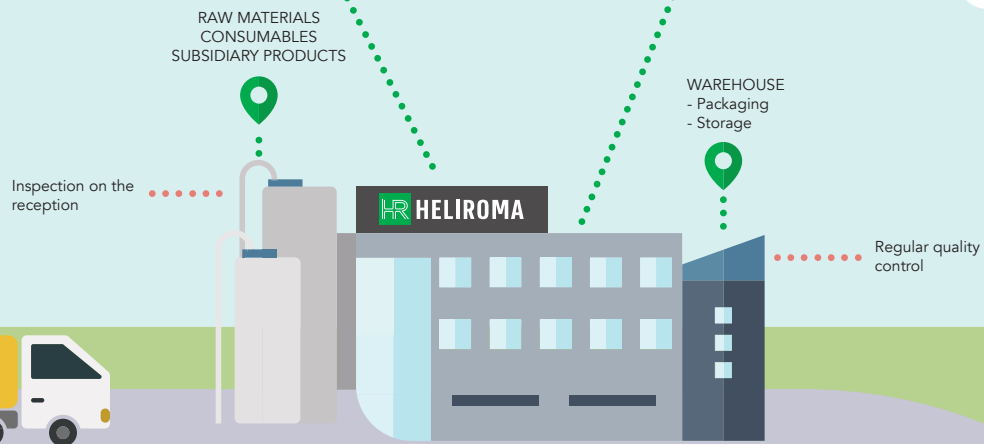
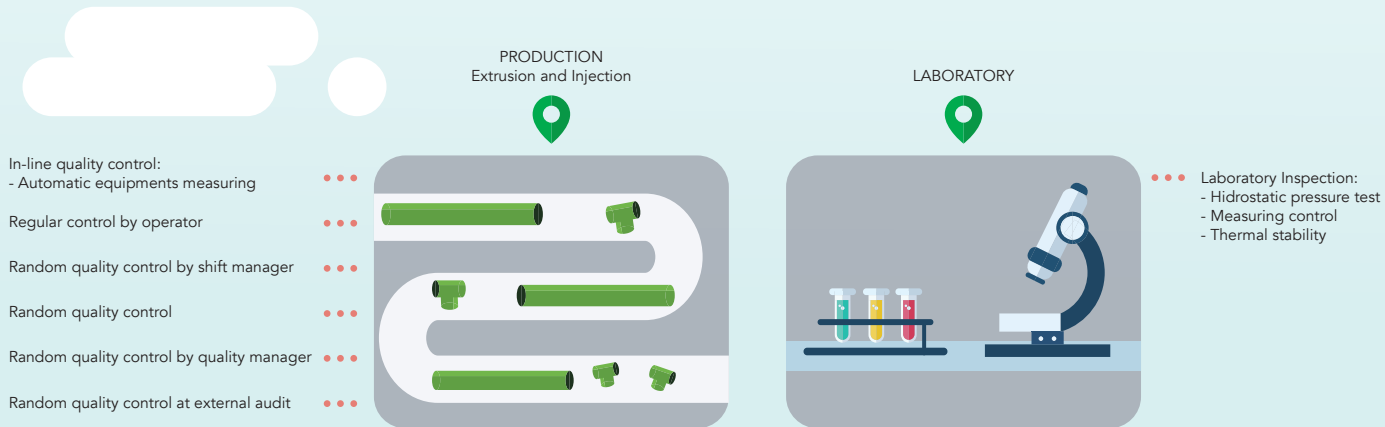

••• Quality control procedures
••• Control points

QUALITY MANAGEMENT POLICY

The Executive Management of HELIROMA assumes and is committed to a set of principles that are part of the **management policy**, considering fundamental to the evolution and success of HELIROMA:

- **Improvement** of its quality management system, its **products** and **services** to meet the needs and expectations of its customers, but also of the other relevant stakeholders, without losing sight of the growth of the business, to continue to ensure the necessary return to its prosperity.
- Evolution of **people**, as an essential factor of their existence, promoting the professional development of their employees and ensuring the adequacy of their skills to the functions they perform;
- Guarantee of the **quality of the products**, which must always be better;
- Preserving the **environment**, controlling and managing all production waste, in accordance with applicable legislation and regulations;
- Profit as a final measure of efficiency and as a necessity for the **growth** of HELIROMA.
- Commitment to providing **safe products**, which satisfy the requirements of customers and which comply with the applicable legal, normative, statutory and regulatory requirements.

CERTIFICATIONS

National and international independent authorities and institutions confirm HELIROMA's quality standard.



SUSTAINABILITY

Sustainability and ecological responsibility play a key role with all entrepreneurial decisions and in the entire value chain.

The **consumption of water** in each home from drinking water to heating, requires due attention when creating the most sustainable solutions. When talking about topics such as corrosion, energy efficiency, durability and the quality of the water consumption, the choice of the pipes and fittings in each building is essential.

All HELIROMA's production processes and products are aligned with the guidelines of sustainability and **energy efficiency**, meeting the ecological and environmental standards required or recommended today, allowing the choice to be evident.

HELIROMA's systems have a **life expectancy of more than 50 years**, rarely needing extensive maintenance or repairs, and do not generate waste discharge.

In addition, polypropylene and polyethylene are an environmentally friendly material, are fully recyclable and can be reused in other applications and in different areas.

HELIROMA takes responsibility in creating a **sustainable supply chain**. Maximizing the efficiency of supplier logistics, makes an important contribution to our controlled carbon footprint.

HELIROMA contributes daily to the design and development of construction projects and is committed to support the construction industry to create the **least environmental impact**.

Sustainability is a driving force within HELIROMA's strategy.





PP-R

1

PP-R SYSTEM

- PP-R 100, PP-R 100 + FG, PP-RCT 125 + FG
- PP-R 100 - HELISYSTEM
- PP-R 100 + FG - ROMAFASER & ROMAKLIMA
- PP-RCT 125 + FG - ROMAFASER CT & ROMAKLIMA CT

INSTALLATION GUIDELINES

WELDING TECHNOLOGY

SYSTEM FEATURES

SYSTEM GENERAL ADVANTAGES

CERTIFICATIONS

PRODUCT RANGE

- PP-R pipes
- PP-R fittings
- Electrofusion fittings
- Fittings for electrofusion
- PP-R Tools

PP-R SYSTEM

PP-R 100 | PP-R 100 + FG | PP-RCT 125 + FG



CHARACTERISTICS



APPROVED FOR DRINKING WATER



DISINFECTION RESISTANT



ANTIMICROBIAL



LEGIONELLA CONTROL



HEATING SYSTEMS



100% RECYCLABLE



ECO-FRIENDLY

PLASTIC PIPES CLASSIFICATION

SDR Standard dimension ratio – ratio between pipe's outside diameter and it's wall thickness

$$SDR = \frac{d_e}{e}$$

S Series - dimensionless index, which is used for the calculation of the wall thickness of the pipe

$$S = \frac{d_e - e}{2e}$$

d_e Outside diameter of the pipe

e Wall thickness of the pipe

MATERIAL

PP Polypropylene

PP-R Polypropylene Copolymer Random

PP-R 100 Polypropylene Copolymer Random 100

PP-RCT 125 Polypropylene Copolymer Random with modified crystallinity 125

FG Fiberglass

PRODUCT RANGE OVERVIEW

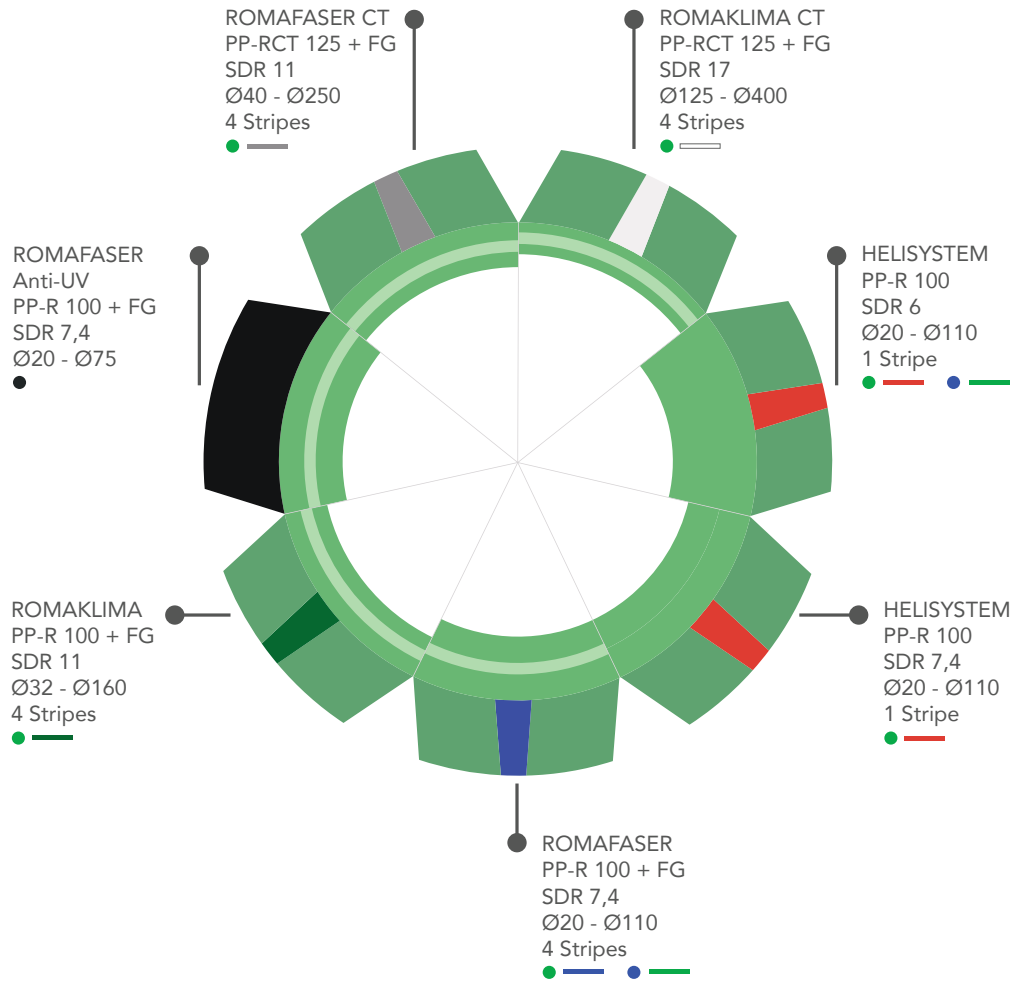

HELIROMA PP-R PIPES																
DIAMETERS (mm)	20	25	32	40	50	63	75	90	110	125	160	200	250	315	355	400
HELISYSTEM PP-R 100 SDR 6	✓	✓	✓	✓	✓	✓	✓	✓	✓							
HELISYSTEM PP-R 100 SDR 7,4	✓	✓	✓	✓	✓	✓	✓	✓	✓							
ROMAFASER PP-R 100 + FG SDR 7,4	✓	✓	✓	✓	✓	✓	✓	✓	✓							
ROMAKLIMA PP-R 100 + FG SDR 7,4	✓	✓														
ROMAKLIMA PP-R 100 + FG SDR 11			✓	✓	✓	✓	✓	✓	✓	✓	✓					
ROMAFASER ANTI-UV PP-R 100 + FG SDR 7,4 ANTI-UV	✓	✓	✓	✓	✓	✓	✓									
ROMAFASER CT PP-RCT 125 + FG SDR 7,4	✓	✓	✓													
ROMAFASER CT PP-RCT 125 + FG SDR 11				✓	✓	✓	✓	✓	✓	✓	✓	✓	✓			
ROMAKLIMA CT PP-RCT 125 + FG SDR 17										✓	✓	✓	✓	✓	✓	✓

Notes:

Pipes ø 20 - 125mm → socket welding;

Pipes ø 160 - 400mm → butt welding;

Other colours or dimensions available on demand.

PP-R SYSTEM

PP-R 100 - HELISYSTEM

PP-R 100

Polypropylene is a versatile polymer present in our lives. It is a polymer made from a simple carbon-carbon and carbon-hydrogen bond. It is obtained through the polymerisation of propylene, in the presence of catalysts under certain pressure and temperature conditions. Polypropylene copolymer random is characterised by its high molecular weight and resistance to high operating temperatures and pressure, ensuring strength and long lifecycles. Making it suitable for pipe production.

HELISYSTEM - PP-R 100 SDR 6 | PP-R 100 SDR 7,4

The polypropylene used in HELISYSTEM pipes and fittings is classified as PP-R 100, with a mechanical resistance stress (MRS) 10.0 MPa, not 8.0 MPa the standard PP-R.

The PP-R 100 is the latest development in PP-R family, complying with reference curves simultaneously at 20°C, 70°C, 95°C and 110°C based on third party testing and ISO/TR 9080 assessment.

The PP-R 100 monolayer system includes pipes with different thicknesses - SDR 6, SDR 7,4 and more than 250 fittings and connection elements such as valves and ball valves to complete the system.

HELISYSTEM SDR 6 is supplied in green or blue colour with 1 longitudinal red or green line, respectively.

HELISYSTEM SDR 7,4 is supplied in green colour with 1 longitudinal red line.



PP-R 100

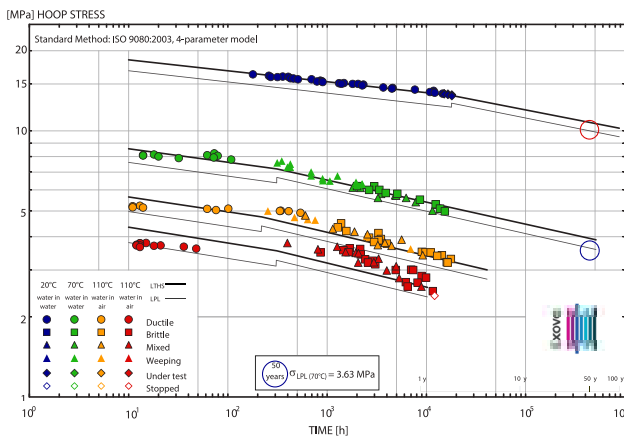

PP-R 80

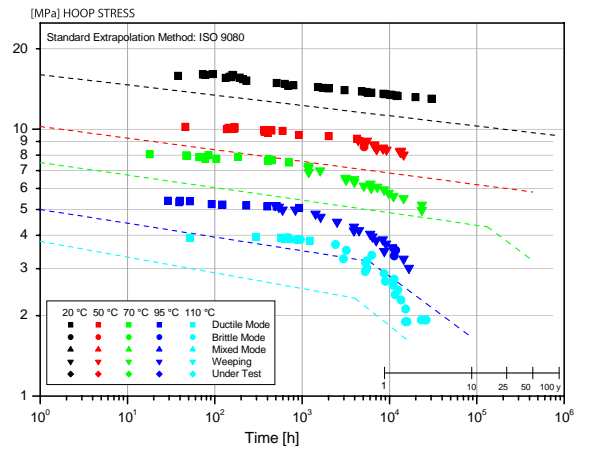





50 years $\sigma_{LPL} = 10.02 \text{ MPa}$
MRS = 10 MPa

50 years $\sigma_{LPL} = 9.58 \text{ MPa}$
MRS = 8.0 MPa

PP-R 100: RAW MATERIAL AND PIPES PROPERTIES

PARAMETER	VALUE	STANDARD
PHYSICAL		
Density	897 kg/m ³	ISO 1133
MFI 230°/2,16 kg	0,3 g/10min	ISO 1133
MFI 230°/5,00 kg	1,3 g/10min	ISO 1133
MFI 190°/5,00 kg	0,5 g/10min	ISO 1133
Viscosity	420 mL/g	ISO 1628-3
Roughness	0,007 mm	ISO 5436
Pipe Constant	20	
Opacity	Yes	ISO 7686
MECHANICAL		
Tensile Modulus (23°C)	850 MPa	ISO 527
Tensile Stress at Yield	24 MPa	ISO 527
Tensile Strain at Yield	13%	ISO 527
Tensile Creep Modulus 1h	650 Mpa	ISO 899
Tensile Creep Modulus 1000h	350 MPa	ISO 899
Flexural Stress at 3,5% Deflection	20 MPa	ISO 178
MRS	10.0 MPa	ISO 9080
THERMAL		
Thermal Conductivity	0,135 W/mK	DIN 52612
Thermal Expansion Coefficient	0,150 mm/m°C	VDE 0304
Vicat Softening Temperature (A50)	132°C	ISO 306
Vicat Softening Temperature (B50)	69°C	ISO 306
DSC Melting Point	139°C	DSC
CLTE	0,00015 cm/cm/°C	ISO 11359
OIT	40 min	ISO 11357
Fire Classification	B2	DIN 4102
IMPACT		
Charpy Impact Strength Unnotched 23°C	No break	ISO 179
Charpy Impact Strength Unnotched 0°C	No break	ISO 179
Charpy Impact Strength Unnotched -20°C	43 KJ/m ²	ISO 179
Charpy Impact Strength Notched 23°C	89 KJ/m ²	ISO 179
Charpy Impact Strength Notched 0°C	12 KJ/m ²	ISO 179
Charpy Impact Strength Notched -20°C	2,7 KJ/m ²	ISO 179
HARDNESS		
Ball Indentation Hardness (H 132/30)	45 MPa	ISO 2039
Shore Hardness (shore D)	65	ISO 868
ELECTRICAL		
Specific Surface Resistivity	10 ¹⁴ Ω	IEC 93
Specific Resistance	> 10 ¹⁷ Ω cm	
Relative Permittivity	2,3 (in case of 1 MHz)	
Puncture Voltage	500 kV/cm	
Dissipation Coefficient	0,0002 (in case of 50 Hz)	

ADVANTAGES AND KEY FEATURES OF HELISYSTEM

-  LONG LIFE EXPECTANCY
-  EXCELLENT LONG-TERM PRESSURE RESISTANCE
-  LOW PRESSURE LOSS
-  LOW THERMAL CONDUCTIVITY
-  ECO-FRIENDLY
-  CORROSION RESISTANT
-  HIGH CHEMICAL RESISTANCE
-  LOW ROUGHNESS
-  DRINKABLE WATER APPLICATIONS
-  EXTREMELY RELIABLE
-  PREVENTS LIMESCALE
-  ACOUSTIC INSULATION
-  EASY AND FAST INSTALLATION
-  SUPPLIED IN BARS
-  IDEAL FOR OFFSET CONSTRUCTION
-  NATIONAL AND INTERNATIONAL CERTIFICATIONS

APPLICATIONS

HELISYSTEM PP-R 100 SDR 6 and SDR 7,4 has a wide range of applications, as well as working pressures and temperatures such as: new installations, repairs, renovations and prefabricate installations.

This system is suitable for applications including: drinking water installations, sanitary systems, hot and cold water distribution, heating and cooling systems, district heating, community systems, industrial applications. In specific applications, HELIROMA should be consulted.

The EN ISO 15874 PP-R define four classes of application, with a specific combination of working pressure and temperature. In the table below is shown the working pressure and temperature for PP-R SDR 6 and PP-R SDR 7,4 pipes, according to the standard.

APPLICATION CLASS	P _D (bar)	
	PP-R SDR 6 S2.5	PP-R SDR 7,4 S3.2
1 Hot water supply 60°C	10	8
2 Hot water supply 70°C	8	6
4 Underfloor heating and low temperature radiators	10	10
5 High-temperature radiators connection	6	6

PP-R 100
has a better performance than traditional PP-R 80

PIPE MARKING

The following sequence must be printed once per meter in all pipes.

Example:

HR HELIROMA HELISYSTEM EN ISO 15874-2 AENOR 001/621 DVGW DW-8317CU0307 Certif WRAS ICECON 016-05/3800-2019 QB-166-1851 14/13-1851 (Classe 2/6 bar 70°C)-(Classe 4/10 bar 60°C) 50 years
DIN 8077/8078 GERMANY standards opaco PP-R d_e x e - A PN20 SERIE 2,5 SDR 6 CLASSE 1/10 2/8 4/10 5/6 bar L DD/MM/YYYY HH:MM N°OP Made in Portugal

MARKED SYMBOL	DESCRIPTION
HR Heliroma	Manufacturer's name
Helisystem	Product trade mark
EN ISO 15874-2	Product standards
AENOR, DVGW, Certif, WRAS, ICECON, QB	Certificates, approvals
Opaco	Opacity
PP-R 100	Material
d _e x e	Nominal outside diameter x nominal wall thickness
A	Pipe dimension class (according EN ISO 15874)
PN20	Nominal pressure
S 2.5	Pipe series S
SDR 6	SDR of the pipe
CLASSE 1/10 2/8 4/10 5/6 bar 50 years	Application class combined with operating pressure (according EN ISO 15874)
L	Machine number
DD/MM/YYYY HH:MM	Date of manufacture
N°OP	Production order number
Made in Portugal	Additional information



DIMENSIONS AND FLOW RATE

PIPE	DN	Wall Thickness (mm)	Speed (m/s)	Flow Capacity		
				m³/h	L/s	L/h
HELISYSTEM PP-R 100 SDR 6 S2.5	20	3,4	2	0,985	0,274	985
	25	4,2		1,558	0,433	1558
	32	5,4		2,542	0,706	2542
	40	6,7		4,001	1,111	4001
	50	8,3		6,308	1,752	6308
	63	10,5		9,975	2,771	9975
	75	12,5		14,137	3,927	14137
	90	15		20,358	5,655	20358
	110	18,3		30,466	8,463	30466
HELISYSTEM PP-R 100 SDR 7,4 S3.2	20	2,8	2	1,173	0,326	1173
	25	3,5		1,832	0,509	1832
	32	4,4		3,044	0,845	3044
	40	5,5		4,756	1,321	4756
	50	6,9		7,410	2,058	7410
	63	8,6		11,862	3,295	11862
	75	10,3		16,735	4,649	16735
	90	12,3		24,187	6,719	24187
	110	15,1		36,010	10,003	36010

PERMISSIBLE WORKING PRESSURE

Potable water applications - open systems in permanent operation

TEMPERATURE (°C)	PERMISSIBLE WORKING PRESSURE (bar)		
	LIFETIME (years)	HELISYSTEM PP-R 100 SDR 6 S2.5	HELISYSTEM PP-R 100 SDR 7,4 S3.2
20	1	30,52	24,23
	5	28,65	22,78
	10	27,88	22,19
	25	26,95	21,42
	50	26,27	20,83
30	1	25,93	20,57
	5	24,31	19,30
	10	23,63	18,79
	25	22,78	18,11
	50	22,19	17,60
40	1	22,02	17,51
	5	20,57	16,32
	10	19,98	15,90
	25	19,21	15,30
	50	18,70	14,79
50	1	18,62	14,79
	5	17,34	13,77
	10	16,83	13,26
	25	16,15	12,84
	50	15,73	12,50
60	1	15,73	12,50
	5	14,62	11,56
	10	14,11	11,22
	25	13,60	10,80
	50	13,18	10,46
70	1	13,18	10,46
	5	12,24	9,69
	10	11,82	9,44
	25	10,29	8,16
	50	8,67	6,89

Safety factor - 1,5.

The referenced service lifetime does not consider installation changes, such as: high concentration of disinfection agents, metallic materials out of specification, neither operating temperature and/or pressure malfunctions.

For sanitary water installations, working pressures should be reduced by 15%, for the same service lifetime. The maximum allowable temperature is 70°C, which corresponds to thermal disinfection temperature and not to continuous operating temperature. Disinfection processes should be carried out according to mandatory regulations and under no circumstance a combination of different processes should be used.

In case of butt-welded pipes and/or fittings, allowable operating pressures should be reduced by 25%.

PP-R SYSTEM

PP-R 100 + FG - ROMAFASER & ROMAKLIMA

PP-R 100 WITH FIBERGLASS

HELIROMA developed a new family of pipes to increase maximum operating temperatures and improve overall performance, a faser pipe with 3-layers, a co-extrusion process.

The middle layer is a compound of fiberglass and PP-R 100, it is perfectly integrated in the pipe wall, the inner and outer layers remain unchanged and made of PP-R 100.

The fiberglass expands less than the PP-R when heated, remain rigid at high temperature, thus increasing the stability of the pipe and reduced the linear expansion. The faser is less flexible and requires fewer and smaller expansion controls.

The low concentration of fiberglass in the pipe does not affect the welding process, the recycling, neither water quality, so all other aspects of installation and use remain the same as with monolayer PP-R pipes.

The faser composite pipes allows the improvement of the system without sacrificing any of the other advantages of the pipe.

The system with pipes supplemented by the especially reinforced fiberglass composite includes different types:

ROMAFASER – PP-R 100 + FG SDR 7,4

ROMAKLIMA – PP-R 100 + FG SDR 11

A complete system of fittings and connection elements such as valves and ball valves.

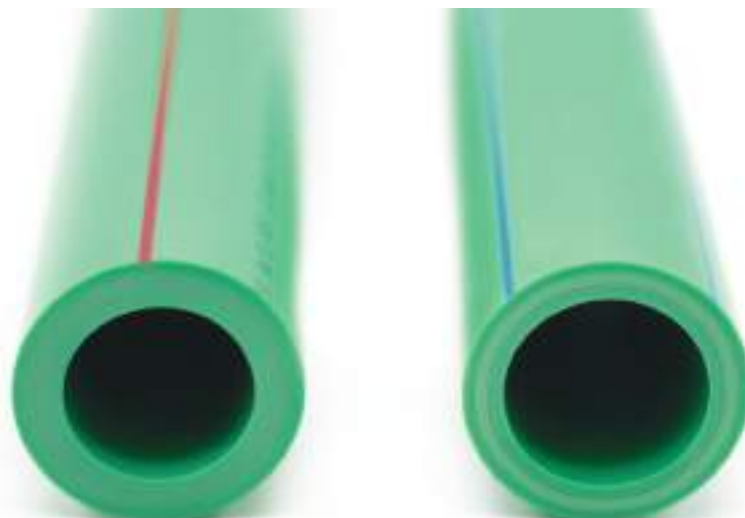
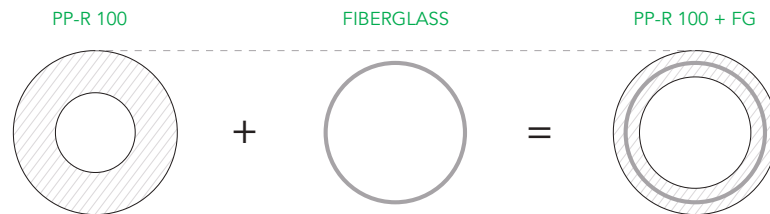

ROMAFASER - PP-R 100 + FG SDR 7,4

ROMAFASER PP-R 100 pipe with fiberglass SDR 7,4, combines chemical and physical safety with durability allowing the application in potable water installations, industrial applications and much more.

The pipe is supplied in green or blue colour with 4 longitudinal blue or green lines, respectively.

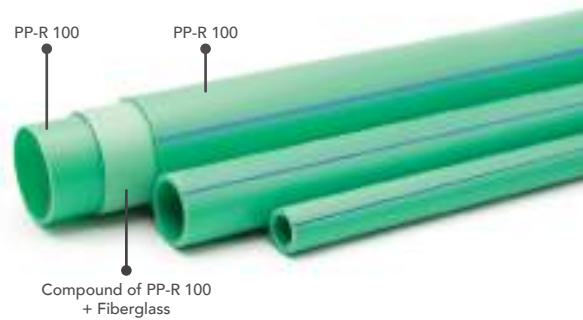

ROMAKLIMA - PP-R 100 + FG SDR 11

ROMAKLIMA PP-R 100 pipe with fiberglass SDR 11, which provides a balanced wall thickness to provide higher flow rates while maintaining high pressures. Suitable for most applications.



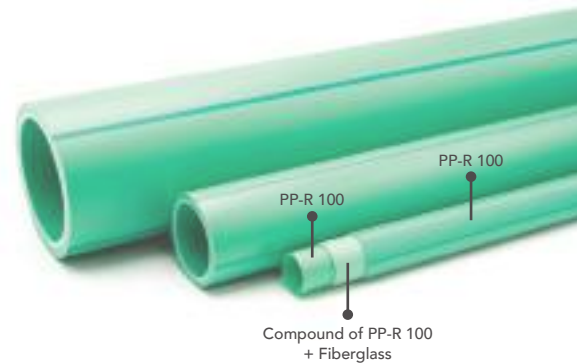















The pipe is supplied in green colour with 4 longitudinal dark green lines.



PP-R 100 + FG: PIPE PROPERTIES

PARAMETER	VALUE	STANDARD
PHYSICAL		
Roughness	0,007 mm	ISO 5436
Pipe Constant	20	
Opacity	Yes	ISO 7686
THERMAL		
Thermal Conductivity	0,135 W/mK	DIN 52612
Thermal Expansion Coefficient	0,035 mm/m°C	VDE 0304
OIT	40 min	ISO 11357
Fire Classification	B2	DIN 4102

ADVANTAGES AND KEY FEATURES OF ROMAFASER AND ROMAKLIMA

-  INCREASED FLOW RATE DUE TO INCREASED INNER DIAMETER;
-  DRINKABLE WATER APPLICATIONS
-  REDUCED THERMAL EXPANSION
-  LONG LIFE EXPECTANCY
-  FEWER SUPPORTS NEEDED
-  CORROSION RESISTANT
-  LIGHTWEIGHT
-  HIGH CHEMICAL RESISTANCE / STABILITY
-  EXCELLENT LONG-TERM PRESSURE RESISTANCE
-  PREVENTS LIMESCALE
-  LOW THERMAL CONDUCTIVITY
-  ACOUSTIC INSULATION
-  LOW PRESSURE LOSS
-  EASY AND FAST INSTALLATION
-  LOW ROUGHNESS
-  SUPPLIED IN BARS
-  ECO-FRIENDLY
-  SEVERAL NATIONAL AND INTERNATIONAL CERTIFICATIONS

APPLICATIONS

The ROMAFASER SDR 7,4 and ROMAKLIMA SDR 11 have a wide range of applications, as well as working pressures and temperatures such as: new installations, repairs, renovations and prefabricate installations.

This system is suitable for applications including: drinking water installations, sanitary systems, hot and cold water distribution, heating and cooling systems, district heating, community systems, industrial applications. In specific applications, HELIROMA should be consulted.

In the table below is shown the working pressure and temperature for ROMAFASER and ROMAKLIMA pipes, according to specific rules and requirements.

APPLICATION CLASS		P _D (bar)	
		ROMAFASER & ROMAKLIMA	
		PP-R 100 + FG SDR 7,4 S3.2	PP-R 100 + FG SDR 11 S5.0
1	Hot water supply 60°C	10	6
2	Hot water supply 70°C	8	4
4	Underfloor heating and low temperature radiators	10	6
5	High-temperature radiators connection	6	-

PIPE MARKING

The following sequence must be printed once per meter in all pipes.

Example:

HR HELIROMA ROMAFASER AENOR CC 001/691 WRAS ICECON 016-05/3800-2019 opaco (PP-R / PP-R+GF / PP-R) Ø 25x3,5 mm SDR 7.4 SERIE 3.2 CLASSE 1/8 2/6 4/10 5/6 bar DIN 8077 / 8078 GERMANY standards L DD/MM/YY HH:MM N° OP Made in Portugal

MARKED SYMBOL	DESCRIPTION
HR Heliroma	Manufacturer's name
ROMAFASER	Product trade mark
AENOR, WRAS, ICECON	Certificates, approvals
Opaco	Opacity
PP-R / PP-R+GF / PP-R	Material
$d_e \times e$	Nominal outside diameter x nominal wall thickness
SDR 7,4	SDR of the pipe
S 3.2	Pipe series S
CLASSE 1/8 2/6 4/10 5/6 bar	Application class combined with operating pressure
DIN 8077 / 8078 GERMANY standards	Product regulations
L	Machine number
DD/MM/YYYY HH:MM	Date of manufacture
N°OP	Production order number
Made in Portugal	Additional information



DIMENSIONS AND FLOW RATE

PIPE	DN	Wall Thickness (mm)	Speed (m/s)	Flow Capacity		
				m³/h	L/s	L/h
ROMAFASER PP-R 100 + FG SDR 7,4 S3.2	20	2,8	2	1,173	0,326	1173
	25	3,5		1,832	0,509	1832
	32	4,4		3,044	0,845	3044
	40	5,5		4,756	1,321	4756
	50	6,9		7,410	2,058	7410
	63	8,6		11,862	3,295	11862
	75	10,3		16,735	4,649	16735
	90	12,3		24,187	6,719	24187
	110	15,1		36,010	10,003	36010
ROMAKLIMA PP-R 100 + FG SDR 11 S5.0	20	2,8	2	1,173	0,3257	1172,6
	25	3,5		1,832	0,5089	1832,2
	32	2,9		3,044	1,0783	3881,7
	40	3,7		4,756	1,6694	6009,8
	50	4,6		7,410	2,6148	9413,3
	63	5,8		11,862	4,1500	14940
	75	6,8		16,735	5,9218	21319
	90	8,2		24,187	8,5089	30632
	110	10		36,010	12,723	45804

PERMISSIBLE WORKING PRESSURE

Non potable water applications - heating systems or closed systems

TEMPERATURE (°C)	PERMISSIBLE WORKING PRESSURE (bar)		
	LIFETIME (years)	ROMAFASER PP-R 100 + FG SDR 7,4 S3.2	ROMAKLIMA PP-R 100 + FG SDR 11 S5.0
10	1	30,2	27,8
	5	28,2	26,2
	10	27,7	25,6
	25	26,9	24,7
	50	26,1	24,1
	100	25,2	23,5
20	1	28,6	23,8
	5	26,8	22,3
	10	26,1	21,7
	25	25,3	21
	50	24,5	20,4
	100	23,7	19,9
30	1	24,3	20,2
	5	22,8	18,9
	10	22,0	18,4
	25	21,3	17,8
	50	20,7	17,3
	100	20,0	16,8
40	1	20,5	17,1
	5	19,2	16
	10	18,7	15,6
	25	18,0	15
	50	17,5	14,6
	100	16,8	14,1
50	1	17,5	14,5
	5	16,2	13,5
	10	15,7	13,1
	25	15,2	12,6
	50	14,7	12,2
	100	14,1	11,9
60	1	14,7	12,2
	5	13,7	11,4
	10	13,2	11
	25	12,6	10,6
	50	12,1	10,3

CONTINUED >

CONTINUED >

TEMPERATURE (°C)	PERMISSIBLE WORKING PRESSURE (bar)		
	LIFETIME (years)	ROMAFASER PP-R 100 + FG SDR 7,4 S3.2	ROMAKLIMA PP-R 100 + FG SDR 11 S5.0
70	1	12,4	10,3
	5	11,4	9,6
	10	11,1	9,2
	25	9,6	8,0
	50	8,1	6,8
80	1	10,4	8,6
	5	9,2	7,7
	10	7,8	6,5
	1	6,2	5,2
95	5	8,7	7,2
	10	6,0	5,1
	50	5,1	4,4

Safety factor - 1,25.

The referenced service lifetime does not consider installation changes, such as: high concentration of disinfection agents, metallic materials out of specification, neither operating temperature and/or pressure malfunctions.

For sanitary water installations, working pressures should be reduced by 15%, for the same service lifetime. The maximum allowable temperature is 70°C, which corresponds to thermal disinfection temperature and not to continuous operating temperature. Disinfection processes should be carried out according to mandatory regulations and under no circumstance a combination of different processes should be used.

In case of butt-welded pipes and/or fittings, allowable operating pressures should be reduced by 25%.

ROMAFASER ANTI-UV - PP-R 100 + FG SDR 7,4 ANTI-UV

ROMAFASER ANTI-UV PP-R 100 + FG pipe with a added outside layer that guarantees UV protection. Therefore, this pipe is the most recommended solution for applications where the installation will be exposed to UV radiation, for example, outdoor applications.

The UV protection layer is made of a specially stabilised PP-R 100 with a special additive that makes highly reliable and resistant to ageing and discolouration caused by UV radiation.

ROMAFASER ANTI-UV pipe can be welded directly, with no need to peel off the outside layer, pipe and fittings can be installed according the normal procedure, without additional steps.

All HELIROMA fittings have UV-stabilizer to resist to UV exposure during transport and installation. However, the fittings are not long-term resistant to UV light, therefore fittings must be protected.

The pipe is supplied in black colour.

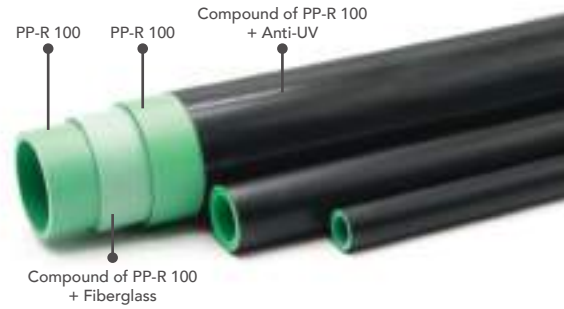

ADVANTAGES AND KEY FEATURES OF ROMAFASER ANTI-UV



UV PROTECTION



EXCELLENT LONG-TERM PRESSURE RESISTANCE



REDUCED THERMAL EXPANSION



LONG SERVICE LIFE



PP-R SYSTEM

PP-RCT 125 + FG - ROMAFASER CT & ROMA KLIMA CT

PP-RCT 125 WITH FIBERGLASS

Polypropylene Random Copolymer - PP-R, is widely used for pipe application in many regions and countries, due to its high temperature performance and the pipe-fitting reliable bond.

In line with the constant progress over the years and with the advance of technology, the evolution emerges from the PP-R 80 a monomodal PP-R, to the bi-modal PP-R based on improved polymerization technology PP-R 100, until today with a hexane modified PP-R made on the Spherizone technology PP-RCT 125.

The new PP-RCT 125 has outstanding performance allowing wall thickness reduction without compromising internal pressure resistance.

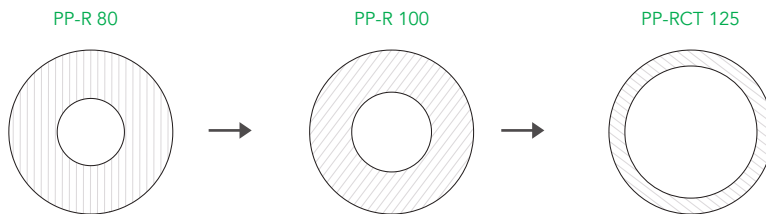

IMPROVEMENTS

- Higher resistance to pressure and stress;
- Increased MRS;
- Reduced wall thickness may be used, assuring same pressure resistance;
- Lower weight;
- Less material consumption;
- High hydraulic capacity;
- Improved high temperature performance;
- Long term performance.

Based on Polypropylene copolymer Random with modified crystallinity-PP-RCT 125 production process resulting in products with outstanding properties such as: pressure resistance, high chemical resistance, creep and long-term performance.

PP-RCT 125

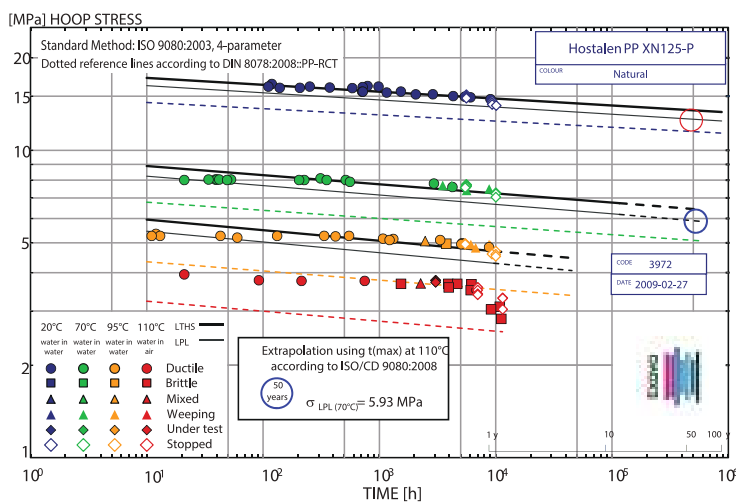

In EN ISO 9080, the increase in CRS value (extrapolated to 50 years) at typical application temperature of 70°C can allow for a significant reduction of pipe wall thickness.

HELIROMA sets the innovation in the production of polymeric pipes, the current level of evolution is a Faser CT pipe made of Polypropylene copolymer Random with modified crystallinity-PP-RCT 125 with fiberglass.

A middle layer is a compound of fiberglass and PP-RCT 125, it is perfectly integrated in the pipe wall, the inner and outer layers remain unchanged, they are made of PP-RCT 125.

A piping system providing higher pressure resistance with thin wall, high chemical stability, highly resistant to corrosion, is lightweight and robust. The quality of Faser CT pipes combines a high quality raw material with engineering expertise.

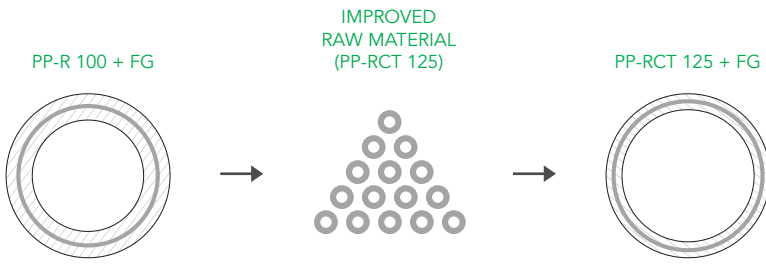

IMPROVEMENTS

An unique combination of raw materials and production process, resulting the latest generation of faser pipes.

- High performance;
- High flow rate;
- Reduced weight.

The ideal system for the most aggressive working conditions with high durability. The system includes different types of pipes, that are completed with more than 180 settings of fittings and connection elements as well as valves and ball valves:

ROMAFASER CT – **PP-RCT 125 + FG SDR 11**

ROMAKLIMA CT – **PP-RCT 125 + FG SDR 17**

ROMAFASER CT and ROMAKLIMA CT have many features, that makes them the best choice for different fields of piping applications.

These systems are compatible with all HELIROMA's PP-R systems.

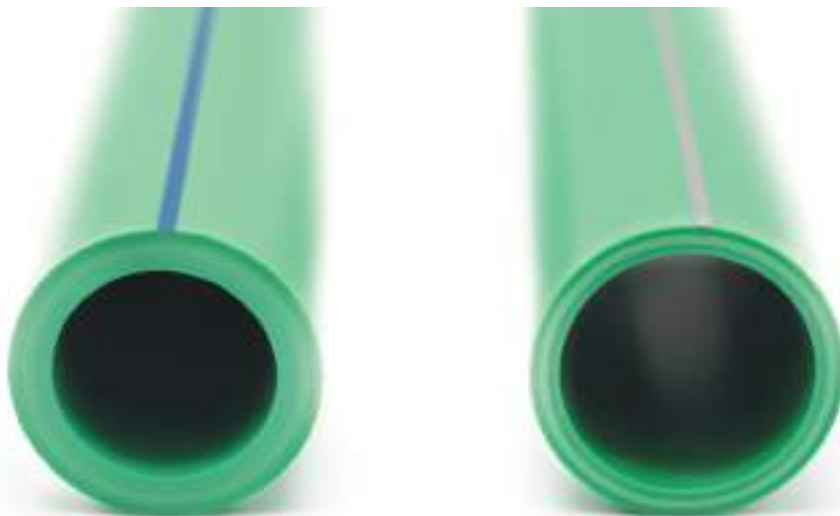

TECHNICAL PROPERTIES: PP-RCT 125 VS PP-R 100

PARAMETER	PP-RCT 125	PP-R 100	STANDARD
PHYSICAL			
MRS	12,5 MPa	10,0 MPa	ISO 9080
σ_{LPL} (20°C)	12,68 MPa	10,02 MPa	
σ_{LPL} (70°C)	5,93 MPa	3,63 MPa	
MFI 230°/2,16 kg	0,2 g/10min	0,3 g/10min	ISO 1133
MFI 230°/5,00 kg	1,0 g/10min	1,3 g/10min	ISO 1133
MFI 190°/5,00 kg	0,4 g/10min	0,5 g/10min	ISO 1133
Density	905 kg/m ³	897 kg/m ³	ISO 1133
MECHANICAL			
Tensile Modulus	850 MPa	850 MPa	ISO 527
Tensile Stress at Yield	26 MPa	24 MPa	ISO 527
Tensile Strain at Yield	12%	13%	ISO 527
Elongation at Yield	10%	12%	
THERMAL			
Cristalization Point Tc	101°C	97,5°C	
DSC Melting Point	136°C	139°C	DSC
OIT	40 min	40 min	ISO 11357
IMPACT			
IZOD Impact, Notched 0°C	13 KJ/m ²	19 KJ/m ²	ISO 179
Charpy Impact Strength Notched 23°C	60 KJ/m ²	89 KJ/m ²	ISO 179
Charpy Impact Strength Notched 0°C	8 KJ/m ²	12 KJ/m ²	ISO 179
Charpy Impact Strength Notched -20°C	2 KJ/ m ²	2,7 KJ/m ²	ISO 179

ROMAFASER CT - PP-RCT 125 + FG SDR 11

ROMAFASER CT a PP-RCT 125 with fiberglass on SDR 11 pipe, that allows increased temperature and working pressure, for higher stress applications. Best solution for hot and cold-water distribution, high and low temperature heating systems and industrial applications.

The pipe is supplied in green colour with 4 longitudinal grey lines.

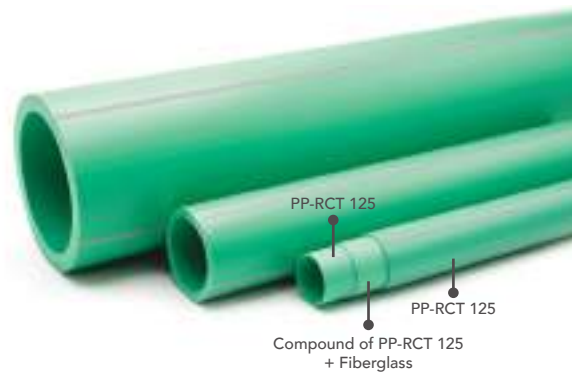

ROMAKLIMA CT - PP-RCT 125 + FG SDR 17

ROMAKLIMA CT a PP-RCT 125 with fiberglass SDR 17 pipe, with a thin wall that will provides maximum flow rate while reducing material weight, cost and welding times. It can be used in applications such as high-pressure, high-temperature heating and industrial process systems.



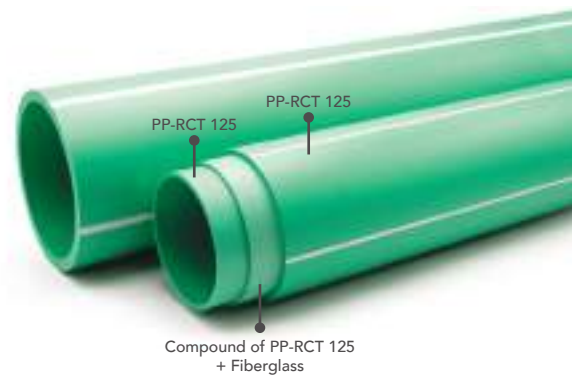

















The pipe is supplied in green colour with 4 longitudinal white lines.



PP-RCT 125 + FG: PIPE PROPERTIES

PARAMETER	VALUE	STANDARD
THERMAL		
Thermal Conductivity	0,135 W/mK	DIN 52612
Thermal Expansion Coefficient	0,035 mm/m°C	VDE 0304
OIT	40 min	ISO 11357
Fire Classification	B2	DIN 4102
PHYSICAL		
Roughness	0,007 mm	ISO 5436
Pipe Constant	20	
Opacity	Yes	ISO 7686

ADVANTAGES AND KEY FEATURES OF ROMAFASER CT AND ROMAKLIMA CT

-  HIGH CHEMICAL RESISTANCE
-  DRINKABLE WATER APPLICATIONS
-  INCREASED FLOW RATE DUE TO INCREASED INNER DIAMETER
-  LOW THERMAL CONDUCTIVITY
-  EXCELLENT LONG-TERM PRESSURE RESISTANCE
-  LOW ROUGHNESS
-  REDUCED THERMAL EXPANSION
-  LOW PRESSURE LOSS
-  FEWER SUPPORTS NEEDED
-  HIGH STABILITY
-  LIGHTWEIGHT
-  ACOUSTIC INSULATION
-  LONG LIFE EXPECTANCY
-  EASY AND FAST INSTALLATION
-  CORROSION RESISTANT
-  SUPPLIED IN BARS
-  PREVENTS LIMESCALE
-  ECO-FRIENDLY
-  MOLECULAR DOUBLE-BOND
-  NATIONAL AND INTERNATIONAL CERTIFICATIONS

APPLICATIONS

The ROMAFASER CT SDR 11 and ROMAKLIMA CT SDR 17 have a wide range of applications, as well as working pressures and temperatures such as: new installations, repairs, renovations and prefabricate installations.

This system is suitable for applications including: drinking water installations, sanitary systems, hot and cold water distribution, heating and cooling systems, district heating, community systems, industrial applications. In specific applications, HELIROMA should be consulted.

ROMAFASER CT and ROMAKLIMA CT have a high success around the world, on installation on hotels, schools, offices and several industrial applications.

In the table below is shown the working pressure and temperature for ROMAFASER CT and ROMAKLIMA CT pipes, according specific rules and requirements.

APPLICATION CLASS		P _D (bar)	
		ROMAFASER CT & ROMAKLIMA CT	
		PP-RCT 125 + FG SDR 11 S5.0	PP-RCT 125 + FG SDR 17 S8.0
1	Hot water supply 60°C	6	4
2	Hot water supply 70°C	6	4
4	Underfloor heating and low temperature radiators	6	4
5	High-temperature radiators connection	4	-

On the following table are listed the admissible working pressure for their class of application, according EN ISO 15874.

APPLICATION CLASS	P _o (bar)					
	HELISYSTEM PP-R 100 SDR 6 S2.5	HELISYSTEM PP-R 100 SDR 7,4 S3.2	ROMAFASER PP-R 100 + FG SDR 7,4 S3.2	ROMAKLIMA PP-R 100 + FG SDR 11 S5.0	ROMAFASER CT PP-RCT 125 + FG SDR 11 S5.0	ROMAKLIMA CT PP-RCT 125 + FG SDR 17 S8.0
1 Hot water supply 60°C	10	8	8	6	6	4
2 Hot water supply 70°C	8	6	6	4	6	4
4 Underfloor heating and low temperature radiators	10	10	10	6	6	4
5 High-temperature radiators connection	6	6	6	-	4	-

PIPE MARKING

The following sequence must be printed once per meter in all pipes.

Example:

HR Heliroma ROMAFASER CT (PP-RCT/PP-RCT+FV/PP-RCT) Ø 40x3.7 mm SDR 11 SÉRIE 5 opaco AENOR CC 001/691 Classe 1-2-4/6 5/4 bar 50 years L DD/MM/YY HH:MM N°OP Made in Portugal

MARKED SYMBOL	DESCRIPTION
HR Heliroma	Manufacturer's name
ROMAFASER CT	Product trade mark
PP-RCT/PP-RCT+FV/PP-RCT	Material
d _e x e	Nominal outside diameter x nominal wall thickness
SDR 11	SDR of the pipe
SÉRIE 5	Pipe series S
Opaco	Opacity
AENOR	Certificates, approvals
1-2-4/6 5/4 bar 50 years	Application class combined with operating pressure
L	Machine number
DD/MM/YYYY HH:MM	Date of manufacture
N°OP	Production order number
Made in Portugal	Additional information

DIMENSIONS AND FLOW RATE

PIPE	DN	Wall Thickness (mm)	Speed (m/s)	Flow Capacity		
				m ³ /h	L/s	L/h
ROMAFASER CT PP-RCT 125 + FG SDR 11 S5.0	20	2,8	2	1,1726	0,3257	1172,6
	25	3,5		1,8322	0,5089	1832,2
	32	2,9		3,8817	1,0783	3881,7
	40	3,7		6,0098	1,6694	6009,8
	50	4,6		9,4133	2,6148	9413,3
	63	5,8		14,940	4,1500	14940
	75	6,8		21,319	5,9218	21319
	90	8,2		30,632	8,5089	30632
	110	10		45,804	12,723	45804
	125	11,4		59,064	16,407	59064
	160	14,6		96,75	26,874	96747
	200	18,2		151,35	42,042	151352
	250	22,7		236,72	65,755	236719
ROMAKLIMA CT PP-RCT 125 + FG SDR 17 S8.0	125	7,4	2	68,673	19,076	68673
	160	9,5		112,42	31,229	112424
	200	11,9		175,56	48,768	175563
	250	14,8		274,69	76,303	274692
	315	18,7		435,77	121,048	435774
	355	21,1		553,29	153,693	553294
	400	23,7		703,05	195,292	703051

PERMISSIBLE WORKING PRESSURE

Non potable water applications - heating systems or closed systems

TEMPERATURE (°C)	PERMISSIBLE WORKING PRESSURE (bar)		
	LIFETIME (years)	ROMAFASER CT PP-RCT 125 + FG SDR 11 S5.0	ROMAKLIMA CT PP-RCT 125 + FG SDR 17 S8.0
10	1	28,8	14,4
	5	27,9	14,0
	10	27,5	13,8
	25	27,1	13,5
	50	26,7	13,4
	100	26,3	13,2
20	1	25,0	12,5
	5	24,2	12,1
	10	23,9	12,0
	25	23,5	11,7
	50	23,1	11,6
	100	22,8	11,4
30	1	21,7	10,8
	5	20,9	10,5
	10	20,6	10,3
	25	20,2	10,1
	50	19,9	10,0
	100	19,7	9,8
40	1	18,6	10,6
	5	18,0	10,5
	10	17,7	10,2
	25	17,3	10,2
	50	17,1	10,0
	100	16,8	10,0
50	1	15,9	9,4
	5	15,3	9,3
	10	15,1	9,3
	25	14,7	8,7
	50	14,5	8,6
	100	14,3	8,5
60	1	13,5	8,1
	5	13,0	7,9
	10	12,7	7,5
	25	12,4	7,4
	50	12,2	7,3

CONTINUED >

CONTINUED >

TEMPERATURE (°C)	PERMISSIBLE WORKING PRESSURE (bar)		
	LIFETIME (years)	ROMAFASER CT PP-RCT 125 + FG SDR 11 S5.0	ROMAKLIMA CT PP-RCT 125 + FG SDR 17 S8.0
70	1	11,3	7,3
	5	10,9	7,2
	10	10,7	7,2
	25	10,4	7,1
	50	10,2	7,0
80	1	9,5	6,6
	5	9,0	6,2
	10	8,9	6,2
	25	8,6	6,1
95	1	7,1	5,0
	5	6,7	5,1
	10	6,6	4,8

Safety factor - 1,25.

The referenced service lifetime does not consider installation changes, such as: high concentration of disinfection agents, metallic materials out of specification, neither operating temperature and/or pressure malfunctions.

For sanitary water installations, working pressures should be reduced by 15%, for the same service lifetime. The maximum allowable temperature is 70°C, which corresponds to thermal disinfection temperature and not to continuous operating temperature. Disinfection processes should be carried out according to mandatory regulations and under no circumstance a combination of different processes should be used.

In case of butt-welded pipes and/or fittings, allowable operating pressures should be reduced by 25%.

INSTALLATION GUIDELINES

GENERAL RECOMMENDATIONS

Before starting to work with HELIROMA's products it is very important to read the technical catalogue:

- HELIROMA's systems have to be assembled according to HELIROMA's instructions;
- For applications or conditions not mentioned, make sure to obtain HELIROMA's technical approval;
- All regulations and directives have to be fulfilled on designing and installation phases;
- Product warranty is valid only for HELIROMA's products.

DESIGNING GUIDELINES

Compliance with local regulations is mandatory and responsibility of the installer.

Pressure loss depends on the pipe length, pipe material, type and quantity of fittings, as well the flow rate, which is variable according the number and size of taps and fittings. Pressure Loss Tables, please refer to Annex C.

HELIROMA advises the maximum flow speed to be 2,0 m/s.

HELIROMA's pipe when has to pass through any wall of the building or any other type of construction element that could apply any harmful mechanical stress to it, it should do so inside a sleeve, also with a circular cross-section, of greater diameter and sufficiently resistant.

For vertical flow in exposed installations, the pipe passage way should do at least 3 cm on the side where occasional shocks could occur, in order to protect the pipe.

When the pipe network passes through a construction expansion joint of the building, either on the surface or in a recessed manner, an expansion element or device must be installed so that any structural movements do not apply mechanical stresses to it. The sum of the water hammer and hydrostatic pressure must not exceed the permissible operating overpressure.

FIXING TECHNIQUES

HELIROMA pipes must be installed in compliance with expansion forces:

- The fixing system must absorb the resulting forces;
- The fixing system should withstand water hammer effect, sagging any mechanical load;
- The pipes must be fixed on the required position.

Clamps and supports must be selected in accordance with the outside diameter of the pipe and must have rubber protection in order to prevent any possible damage from the direct contact of metal with plastic. Isophonic clamps are recommended. Alternatively protective tape can also be used to prevent direct contact of pipes with clamps. For more details about clamp types and dimensions, please see the image below and table on the next page.

"TRADITIONAL"
ISOPHONIC CLAMP



ARTICULATED
ISOPHONIC CLAMP



ISOPHONIC CLAMP
FOR PIPES WITH ISOLATION



SIZING TABLE CLAMPS			
DIAMETER OF PIPE	SIZE OF CLAMPS		ADMISSIBLE DIAMETER RANGE
(mm)	(mm)	(in)	(mm)
20	22	1/2"	20-25
25	28	3/4"	26-30
32	35	1"	32-36
40	40	1 1/4"	38-43
50	48	1 1/2"	47-51
63	60	2"	60-64
75	75	2 1/2"	75-80
90	90	3"	87-92
110	110	-	107-112
125	125	-	125-130
160	160	6"	159-166
200	200	-	200-212
225	224	-	223-228
250	250	-	249-254
315	315	-	314-319
400	400	-	399-404

Note: in insulated systems larger diameter clamps must be considered.

Along pipe assemblage, it is important to distinguish between **Fixed Point** and **Sliding Point**:

Fixed Point (FP) – Prevents the movement of the pipe, pipe expansion forces as well as additional loads are accommodated in this point, the fixed points segment the pipe on small sections, minimizing tensions. The connection between pipes and clamps is very strong, so the material in contact should be smooth to avoid possible damages on the pipe's surface.

Sliding Point (MP) – Is the point where the axial movement is allowed, without damaging the pipe. Point where the clamps are not tighten to the pipe. They should be placed on a vertical or horizontal directions and it is fundamental that movement is assured. Only the weight forces of the pipe system need to be considered on the sliding points design.

Note: in the directional rises only fixed points should be considered and these points must be placed immediately before and after the derivation points from the columns.

Where the direction of the flow changes, only fixed points should be used in order to avoid material fatigue.



THERMAL EXPANSION

Thermal expansion is defined by the expansion of the system as a consequence of a temperature variation.

In the case of pipes, in which one of the dimensions (length) is much bigger than the others, the significant expansion is the linear expansion.

The linear expansion of the pipe is calculated according to the following formula and can be taken from the table on Annex A.

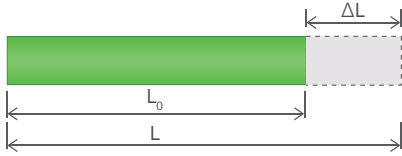

THERMAL EXPANSION FORMULA

$$\Delta L = L - L_0 = L_0 \times \alpha \times \Delta T$$

ΔL	Linear expansion ($L - L_0$) (mm)
L	Final length of the pipe, at T temperature (m)
L_0	Initial length of the pipe, at T_0 temperature (m)
α	Linear expansion coefficient
ΔT	Variation of pipe temperature, in $^{\circ}\text{C}$ ($T - T_0$)

The linear expansion must be considered when the pipe is installed, regardless of the type of installation, being concealed, in ducts, not concealed / wall mounted.

For concealed installations, the resulting stress arising from thermal expansion are not critical as they are absorbed by the material itself, therefore do not require a specific fixing model.

In wall mounted installations, the linear expansion must be taken into account. Dimensional variations of the material have to be compensated, to prevent installation failure.

In situations in which thermal expansion is going to occur, it is necessary to calculate the variation of the length of the pipe sections, considering fixing points capable of "absorbing" these expansions.

Linear expansion due to temperature difference between operating temperature and installation temperature can be compensated by different installation techniques, or combination of techniques.

SUPPORT INTERVALS

Support intervals recommended according to temperature and outside pipe diameter on Annex B.

ABSORPTION ARM

In most cases, direction changes can be used to compensate linear expansion in pipes. The length of the arm (LS) is calculated according to length (L) and pipe dimension, through the following formula:

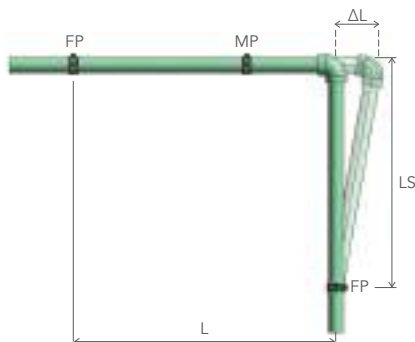

ARM LENGTH FORMULA

$$LS = C \times \sqrt{d_e \times \Delta L}$$

LS	Length of absorption arm (mm)
C	Pipe specific constant
d_e	Outside diameter of the pipe
ΔL	Linear expansion coefficient

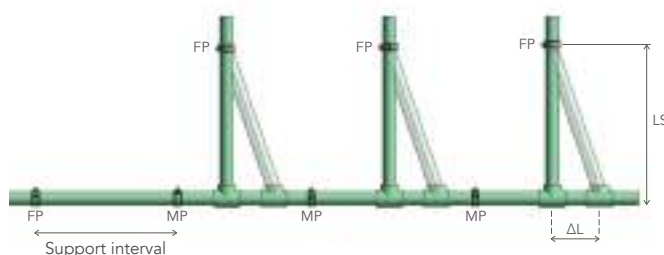

EXPANSION LOOP

The expansion loop is equivalent to two absorption arms, and are used if the linear expansion is not compensated on absorption arm. For distances over 12 linear meters the use of absorption arms expansion loops are essential in order to avoid stress concentrate.

ABSORPTION BEND FORMULA

$$LC = 2 \times \Delta L + ms$$

LC Minimum width of the bend (mm)

ΔL Linear expansion (mm)

ms Minimum safety = 150mm

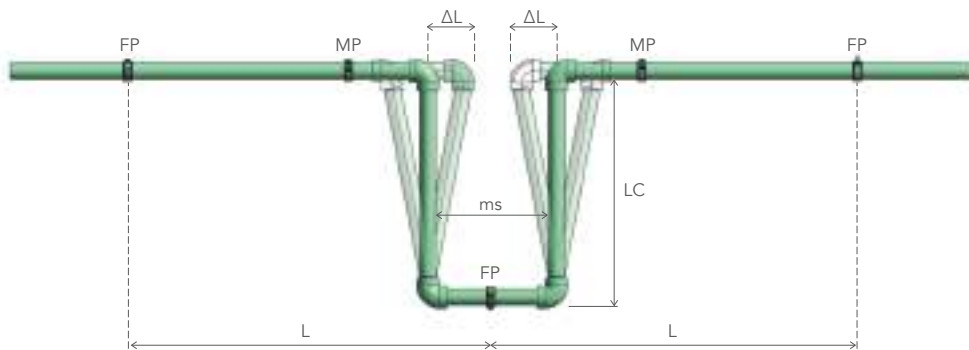

Example:

Dimension of the rod = 4 meters
Diameter of the pipe = 25 mm
 $\Delta T = 40^\circ\text{C}$

Calculation of the thermal expansion
 $\Delta L = 4 \times 0,15 \times 40$
 $= 24 \text{ mm}$

Calculation of the length of the absorption arm for the previous example

$$L_s = 20 \times \sqrt{25 \times 24}$$

$$= 20 \times 24,5$$

$$= 490 \text{ mm}$$

Calculation of the absorption bend

$$L_c = 2 \times 24 + 150$$

$$= 198 \text{ mm}$$

EXPANSION LOOP - PRE-TENSIONING

If on the installation, the space is limited, it's possible to reduce the LC, as well as the LS by pre-stressing.

Pre-stress installation, when planned and carried out carefully, the linear expansion is hardly visible.

LENGTH OF PRE-STRESS FORMULA

$$LSP = C \times \sqrt{d_e} \times \frac{\Delta L}{2}$$

LSP Length of pre-stress

C Material specific constant (PP-R: C=20)

d_e Outside diameter of the pipe

ΔL Linear expansion coefficient: $\alpha = 0,15\text{mm/m}^\circ\text{C}$

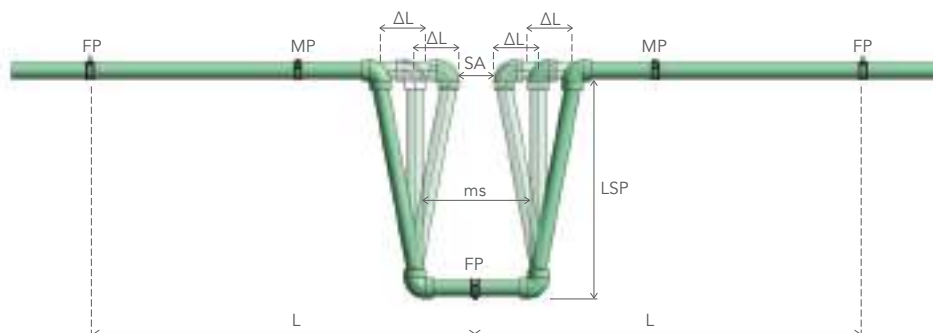

INSULATION

The thermal insulation of pipelines and fittings would be taken into consideration to: protect pipes against condensation, protect the cold-water pipes against exposure to heat, minimize heat losses, reduce the transfer of heat to the structures around, reduce the sound transmission, protect against external corrosion and protect against mechanical stress.

Due to the good insulation characteristics of PP-R, insulation thickness can be less than the one used with metallic piping systems. The thermal conductivity coefficient of PP-R is 0,135 W/mK, copper pipe is 401 W/mK and iron pipe is 80,2 W/mK.

Cooling pipes must be provided with suitable insulation to prevent condensation. Condensation occurs when the temperature of a surface falls below the saturation temperature of the surrounding air. The saturation temperature of the air is determined from the current temperature and the relative humidity.

The temperature of the surface is determined by the heat transfer from the pipe surface, from the air to the pipe surface, and the heat transfer through the pipe's wall.

The insulation thickness depends on the required working conditions and specific national requirements and guidelines.



LEAKAGE TEST

All HELIROMA products must be submitted to a leakage test. The product warranty is only valid if the leakage test has been performed, on the date the system has been installed.

The test must be carried out using water. To use a different fluid, please contact HELIROMA technical department. The system should be purged before the test has been performed.

During the leakage test the temperature must be constant, the variations on temperature has impact on the pressure test result. Due to the properties of the materials used, plastic pipes expand for a limited period of time when they are subjected to pressure. This has an impact on the test result.

The test procedure has three phases, preliminary, principal and final phase, the pressure in each phase depends on the pipe. Please refer to the protocol recommended on Annex D.

The sealing of the system must be evident, and after that must be confirmed with a written record, that has to be signed by the installer, stating place and date and sent to HELIROMA technical department.



CHEMICAL RESISTANCE

Polypropylene is characterized by its high resistance to a different range of chemical substances which might be in a gaseous or liquid form at different temperatures and pressures. Thanks to the special properties of its raw material, HELIROMA systems features excellent chemical resistance. Fittings with brass inserts have different chemical resistance due to the PP-R components.

In the table below, there is a list that establishes a provisional classification of chemical resistance of PP-R with respect to about 180 fluids. It's intended to provide general guidelines on the possible utilization of polypropylene pipes.

For specific application where chemical substances should flow on our pipes, please contact HELIROMA technical department to work out suitable solutions with you.

CHEMICAL	CONCENTRATION	20°C	60°C
Acetic acid	> 40%	✓	✓
Acetic acid	50%	✓	✓
Acetic acid, glacial	>96%	✓	□
Acetic anhydride	100%	✓	-
Acetone	100%	✓	✓
Acephenone	100%	✓	□
Acrylonitrile	100%	✓	-
Air		✓	✓
Almond oil		✓	-
Alum	Sol	✓	-
Ammonia, aqueous	>30%	✓	-
Ammonia, dry gas	100%	✓	-
Ammonia, liquid	100%	✓	-
Ammonium acetate	100%	✓	✓
Ammonium chloride	Sat. sol	✓	-
Ammonium fluoride	Sol	✓	✓
Ammonium hydrogen carbon	Sat.sol	✓	✓
Ammonium hydroxide	Sat.sol	✓	-
Ammonium metaphosphate	Sat.sol	✓	✓
Ammonium nitrate	Sat.sol	✓	✓
Ammonium phosphate	Sat.sol	✓	-
Ammonium sulphate	Sat.sol	✓	✓
Amyl acetate	100%	□	-
Amyl alcohol	100%	✓	✓
Aniline	100%	✓	✓
Apple juice	100%	✓	-
Aqua regia	HCl/HNO ₃ =3/1	×	×
Barium carbonate	Sat.sol	✓	✓
Barium chloride	Sat.sol	✓	✓
Barium hydroxide	Sat.sol	✓	✓
Barium sulphate	Sat.sol	✓	✓
Benzene	100%	✓	×
Benzoic acid	Sat.sol	□	-
Benzyl alcohol	100%	✓	□
Borax	sol	✓	✓
Boric acid	Sat.sol	✓	-
Bromine, gas		□	×
Bromine, liquid	100%	×	×

CHEMICAL	CONCENTRATION	20°C	60°C
Butane	100%	✓	-
Butanol	100%	✓	□
Butyl acetate	100%	✓	□
Butyl glycol	100%	✓	-
Butyl phenol	Col.sat.sol	✓	-
Butyl phthalate	100%	✓	□
Calcium carbonate	Sat.sol	✓	✓
Calcium chloride	Sat.sol	✓	✓
Calcium hydroxide	Sat.sol	✓	✓
Calcium hypochlorite	Sol	✓	-
Calcium nitrate	Sat.sol	✓	✓
Camphor oil		×	×
Carbon dioxide, dry gas	100%	✓	✓
Carbon dioxide, wet		✓	✓
Carbon disulphide	100%	✓	×
Carbon tetrachloride	100%	×	×
Castor oil	100%	✓	✓
Caustic soda	>50%	✓	□
Chlorine, aqueous	Sat.sol	✓	□
Chlorine, dry gas	100%	×	×
Chlorine, liquid	100%	×	×
Chloroacetic acid	Sol	✓	-
Chloroethanol	100%	✓	-
Chloroform	100%	□	×
Chlorosulphonic acid	100%	×	×
Chome alum	Sol	✓	✓
Chromic acid	>40%	✓	□
Citric acid	10%	✓	✓
Coconut oil		✓	-
Com oil		✓	□

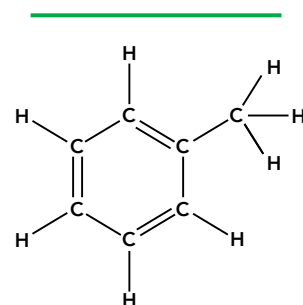

CHEMICAL	CONCENTRATION	20°C	60°C
Cottonseed oil		✓	-
Cresol	>90%	✓	-
Copper III Chloride	Sat.sol	✓	-
Copper III nitrate	30%	✓	✓
Copper III sulphate	Sat.sol	✓	-
Cyclohexane	100%	✓	-
Cyclohexanol	100%	✓	-
Cyclohexanone	100%	□	×
Dextrose	Sol	✓	✓
Dibutyl phthalate	100%	✓	□
Dichloroacetic acid	100%	□	-
Dicloroethylene (A-B)	100%	□	-
Diethanolamina	100%	✓	-
Diethyl ether	100%	✓	□
Diethylene glycol	100%	✓	✓
Diglycolic acid	Sat.sol	✓	-
Disooctyl phthalate	100%	✓	□
Dimethyl amine	100%	✓	-
Dimethyl formalde	100%	✓	✓
Dyetyl phthalate	100%	□	□
Dioxane	100%	□	□
Distilled water	100%	✓	✓
Ethanolamine	100%	✓	-
Ethyl acetate	100%	□	×
Ethyl alcohol	>95%	✓	✓
Ethyl chloride	100%	×	×
Ethylene chloride	100%	□	□
Ethylene glycol	100%	✓	✓
Formaldehyde	40%	✓	-
Formic acid	10%	✓	✓
Formic acid	100%	✓	×
Formic acid anhydrous	Sol	✓	□
Fructose		✓	✓
Fruit juice		✓	✓
Gasoline, petrol		×	×
Gelatine		✓	✓
Glucose	20%	✓	✓
Glycerine	100%	✓	✓
Glycolic acid	30%	✓	-
Heptane	100%	□	×
Hexano	100%	✓	□
Hydrobromic acid	>48%	✓	-
Hydrochloric acid	2-7%	✓	✓
Hydrochloric acid	10-20%	✓	✓
Hydrochloric acid	30%	✓	□
Hydrochloric acid	35-36%	✓	-
Hydrofluoric acid	Dil.sol	✓	-

CHEMICAL	CONCENTRATION	20°C	60°C
Hydrofluoric acid	40%	✓	-
Hydrogen	100%	✓	-
Hydrogen chloride, dry gas	100%	✓	✓
Hydrogen peroxide	>10%	✓	-
Hydrogen peroxide	>30%	✓	□
Hydrogenic sulphide, dry gas	100%	✓	✓
Iodune in alcohol		✓	-
Isopropyl alcohol	100%	✓	✓
Isopropyl ether	100%	✓	-
Isoctane	100%	□	×
Lactic acid	>90%	✓	✓
Lanoline		✓	□
Linseed oil		✓	✓
Magnesium carbone	Sat.sol	✓	✓
Magnesiou chloride	Sat.sol	✓	✓
Magnesium sulphate	Sat.sol	✓	✓
Malic acid	Sol	✓	✓
Mercury III chloride	Sat.sol	✓	✓
Mercury III cyanide	Sat.sol	✓	✓
Mercury II nitrate	Sol	✓	✓
Mercury	100%	✓	✓
Methyl acetate	100%	✓	✓
Methyl alcohol	5%	✓	□
Methyl amine	>32%	✓	-
Methyl bromide	100%	×	×
Methyl ether ketone	100%	✓	×
Methylene chloride	100%	□	×
Milk	100%	✓	✓
Monochloroacetic acid	>85%	✓	✓
Naphtha		✓	×
Nickel chloride	Sat.sol	✓	✓
Nickel nitrate	Sat.sol	✓	✓
Nickel sulphate	Sat.sol	✓	✓
Nitric acid	10%	✓	×
Nitric acid	30%	✓	-
Nitric acid	40-50%	□	×
Nitric acid (w/ nitrogen dioxide)		×	×
Nitrobenzene	100%	✓	□
Oleis acid	100%	✓	□
Oleum sulphuric acid w/60% SO3)		×	×
Olive oil			✓
Oxalic acid	Sat.sol	✓	□
Oxygen	100%	✓	-
Paraffin oil		✓	□
Peanut oil		✓	✓
Papperming oil		✓	-
Perchloric acid	2N	✓	-

CHEMICAL	CONCENTRATION	20°C	60°C
Petroleum ether		☐	☐
Phenol	5%	✓	✓
Phenol	90%	✓	-
Phosphoric acid	25%	✓	✓
Phosphoric acid	25-85%	✓	✓
Phosphoric oxychlorido	100%	☐	-
Piric Acid	Sat.sol	✓	-
Potassium bicarbonate	Sat.sol	✓	✓
Potassium borate	Sat.sol	✓	✓
Potassium bromate	>10%	✓	✓
Potassium bromide	Sat.sol	✓	✓
Potassium carbonate	Sat.sol	✓	-
Potassium chlorate	Sat.sol	✓	✓
Potassium chloride	Sat.sol	✓	-
Potassium chromate	Sat.sol	✓	✓
Potassium cyanide	Sol	✓	-
Potassium fluoride	Sat.sol	✓	✓
Potassium hydroxide	>50%	✓	✓
Potassium iodide	Sat.sol	✓	-
Potassium nitrate	Sat.sol	✓	✓
Potassium perchlorate	10%	✓	✓
Potassium permanganate	2N	✓	-
Potassium persulphate	Sat.sol	✓	-
Potassium sulphate	Sat.sol	✓	-
Propane	100%	✓	-
Propionic acid	>50%	✓	-
Pyridine	100%	☐	-
Sea water			✓
Silicone oil			✓
Silver nitrate	Sat.sol	✓	✓
Sodium acetate	Sat.sol	✓	✓
Sodium benzoate	35%	✓	-
Sodium carbonate	>50%	✓	✓
Sodium chlorate	Sat.sol	✓	-
Sodium chloride	Sat.sol	✓	✓
Sodium chlorite	2%	✓	☐
Sodium chlorite	20%	✓	☐
Sodium dichromate	Sat.sol	✓	✓
Sodium hydrogen carbonate	Sat.sol	✓	✓
Sodium hydrogen sulphate	Sat.sol	✓	✓
Sodium hydrogen sulphite	Sol	✓	-
Sodium hydroxide	1%	✓	✓
Sodium hydroxide	10-60%	✓	✓
Sodium hypochlorite	5%	✓	-
Sodium hypochlorite	10%	✓	-
Sodium hypochlorite	20%	✓	-
Sodium metaphosphate	Sol	✓	-

CHEMICAL	CONCENTRATION	20°C	60°C
Sodium nitrate	Sat.sol	✓	✓
Sodium perborate	Sat.sol	✓	-
Sodium phosphate (neutral)	Sat.sol	✓	✓
Sodium silicate	Sol	✓	✓
Sodium sulphate	Sat.sol	✓	✓
Sodium sulphide	Sat.sol	✓	-
Sodium sulphite	40%	✓	✓
Sodium thiosulphate	Sat.sol	✓	-
Soybean oil		✓	☐
Stannous chloride (IV)	Sat.sol	✓	✓
Stannous chloride (II)	Sat.sol	✓	✓
Succinic acid	Sat.sol	✓	✓
Sulphur acid	>10%	✓	✓
Sulphur dioxide, dry or wet	100%	✓	✓
Sulphur acid	10-30%	✓	✓
Sulphuric acid	50%	✓	☐
Sulphuric acid	96%	✓	☐
Sulphuric acid	98%	☐	×
Sulphurous acid	Sol.	✓	-
Tartaric acid	10%	✓	✓
Tetrahydrofuran	100%	☐	×
Tetralin	100%	×	×
Thiophene	100%	✓	☐
Toluene	100%	☐	×
Trichloroacetic acid	>50%	✓	✓
Trichloroethylene	100%	×	×
Triethanolamine	sol	✓	-
Turpentine		×	×
Urea	Sat.sol	✓	-
Vinegar		✓	✓
Water brackish, mineral, potable		✓	✓
Whiskey		✓	-
Wines		✓	-
Xylene	100%	×	×
Yeast	Sol	✓	✓
Zinc chloride	Sat.sol	✓	✓
Zinc sulphate	Sat.sol	✓	✓

ABBREVIATIONS

- Sat.sol Saturated aqueous solution, prepared at 20°C
- Sol Aqueous solution at concentration higher than 10%, but not saturated
- Dil.sol Dilute aqueous solution at concentration equal to or lower than 10%
- ✓ Satisfactory
- ☐ Limited
- ×

DISINFECTION

Disinfection is a process very important in the supply of safe water. The destruction of pathogenic microorganisms is necessary and commonly involves the use of reactive chemical agents such as chlorine. Before start the disinfection process it is fundamental analysis all equipments and materials installed on circuit, to assure their capability to the conditions to apply.



CHEMICAL DISINFECTION - DRINKING WATER

Chemical disinfection of drinking water includes a chlorine-based treatment and is intended to maintain a residual chlorine concentration in the water to provide protection from post-treatment contamination and during storage.

In case of continuous disinfection using chlorine, it can be used with a content of free chlorine of up to 0,3 mg/L (value in accordance with 2001 drinking water ordinance). The installation temperature should not exceed 70°C to avoid system early oxydation. Residual disinfection is not necessary where there is no evidence of water contamination, unless specific requirements to provide that.

Chlorine dioxide is absolutely not recommended.

Recommendation of the World Health Organization – guidelines for Drinking-water quality (4th Edition) advises that for effective disinfection, there should be residual concentration of free chlorine of $\geq 0,5$ mg/L after at least 30 minutes contact time at $\text{pH} < 8,0$. A chlorine residual should be maintained through the distribution system. At the point of delivery, the minimum residual concentration of free chlorine should be 0,2 mg/L.

CHEMICAL DISINFECTION - SYSTEM

The disinfection of a system is a discontinuous measure, unlike the disinfection of drinking water. This procedure comprising a drinking water system from the area of contamination to the tapping point of the consumer. Generally, a disinfection must be applied for a short period of time, only in case of an identified contamination.

In case of discontinuous disinfection, it can be done twice a year with a content of free chlorine of 50 mg/L for no more than 12 hours. Alternatively, it can be used 150 mg/L of hydrogen peroxide H_2O_2 for 24 hours.

During the disinfection process the maximum temperature is 30°C.

Chlorinated water based chemical disinfection has a direct influence on the lifetime of a products, pipes and fittings.

Chlorine dioxide is absolutely not recommended.

After disinfection, the system should be thoroughly flushed with fresh water until the free residual chlorine is at the level present in the potable water supplied.

THERMAL DISINFECTION - SYSTEM

Thermal disinfection of a system should be done according to DVGW W551 to the prevention of legionella bacteria. The procedure advises that the water temperature should be set to 70°C for at least 3 minutes at all points of a drinking water system. The maximum admissible temperature and pressure on the installation must be confirmed.

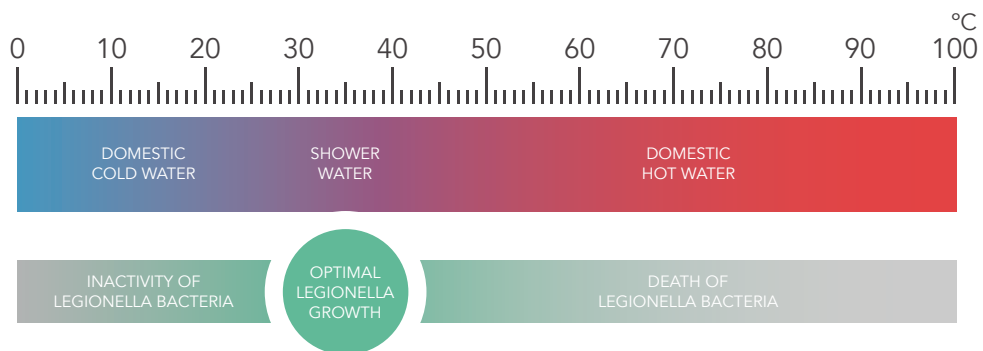

IMPORTANT NOTES

- **Chemical and thermal disinfection cannot be combined.**

- Carrying out shock disinfection at high temperatures, pressures or chemical concentrations, is not allowed, as premature material damage and failure can occur.

- Chlorine dioxide is nowadays the most used disinfectant in some countries. This is explained by the fact that chlorine dioxide is easier to add, cheaper to produce than chlorine, but it is more oxidant. However, it does not provide a residual effect, as chlorine does. The main concerns with chlorine dioxide are with the residual concentrations of chlorine dioxide and the by-products chlorite and chlorate.

The use of chlorine dioxide requires close monitoring. Materials in the drinking water systems are very affected due to the high oxidation potential of a chlorine dioxide.

Along with sealing materials, piping components are damaged too, regardless of whether they are made of plastic or metal. According to the above explanations, chlorine dioxide should not be used in systems as a disinfecting agent.

INTEGRATION OF OTHER SYSTEMS WITH HELIROMA PP-R SYSTEM

The integration between HELIROMA piping system and other compounds not made of PP-R, for example valves, pumps, other piping, strainers, must be considered to ensure that the operating parameters won't damage the HELIROMA piping.

Be aware that HELIROMA pipe systems may not be compatible with other materials on the installation.

HELIROMA pipes and fittings do not require treatment to protect them from corrosion. However, metals in the system may be prone to corrosion.

For example, in the case of the combination of copper and PP-R pipes, the erosion/corrosion of copper pipes and fittings in series with the polymer pipe and fittings results in the presence of copper ions in the system.

These ions are aggressive and at high temperature will promote the oxidation of PP-R. The result is a rapid consumption of stabilizer additives as it attempts to combat the copper-induced reactions. When it is totally consumed the PP-R is left vulnerable to attack.

This reveals as a reduction in OIT and a shorter PP-R lifetime. Further stress accelerates crack formation that propagates under applied thermal and mechanical stress leading to failure.

TRANSPORT AND STORAGE

HELIROMA pipes can be stored indoor or outdoor, preferentially in a covered area, protected from direct sunlight and low temperatures. Pipes and fittings must not be exposed to direct UV-radiation, for long periods. This radiation has effects on the durability of all polymer plastics. Do not store permanently outdoor.

At low temperature, pipes and fittings should be handled carefully, it is possible to damage pipes with strong impacts.

Despite the high quality and resistance of all HELIROMA products, they should be handled with caution. Do not drop pipes when unloading and protect them from falling objects, or equipments. The process of loading, transport and subsequent unloading should be carried out making sure that pipes and fittings do not suffer any damage.

The support of pipes during storage and transportation is fundamental. Therefore, certify that it has a solid base to assure that the pipes are always supported.

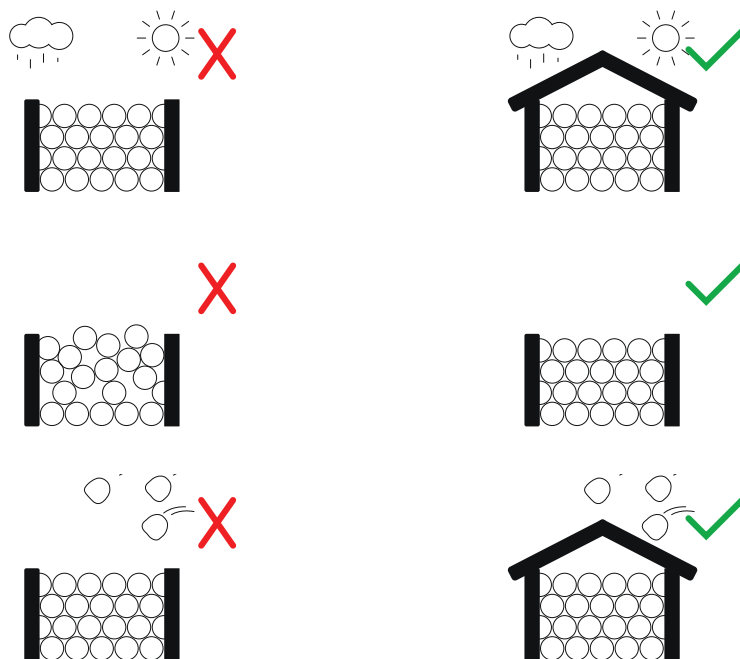

WELDING TECHNOLOGY

In order to obtain good installation results of HELISYSTEM, ROMAFASER and ROMAKLIMA systems, the following recommendations are considered important by HELIROMA and should be taken into consideration, as well as the welding technique and linear expansion.



RECOMMENDATIONS FOR THE APPROPRIATE USE OF THE SYSTEM



RESISTANCE TO UV RAYS

PP-R, such as all thermoplastics, should not be directly exposed to sunlight.



RESISTANCE TO LOW TEMPERATURES

Resistance to low temperature: at low temperatures - close to 0°C, the system becomes less resistant.

Avoid impacts, especially on the ends of the pipes. The use of pipes with incisions or scratches caused by handling is inadvisable.



PIPE CURVATURE

Do not use flames to make curves or deviations, as this can affect the molecular structure of the polypropylene.



SEALING OF METALLIC CONNECTIONS

Use Teflon tape or liquid to avoid leaks. Do not use fittings with ungraded or conical bolts, and tighten without excessive force.



CUT

In order to obtain a cut free from shavings and perpendicular to the pipe's axis, use appropriate cutting equipment.

To avoid the appearance of micro-cracks, cut 2 cm at the end of the pipe, before welding.



CHECKING

For the correct handling, before the start of thermofusion, all devices and tools must be checked.



WEATHER CONDITIONS

Welding area must be protected against weather conditions, for example: rain, wind and temperature changes.



COOLING DOWN CONTROL

During the welding process, cooling down by draft should be avoided.



CLEANING

Welding areas and tools must be clean and free of greases for a perfect welding process.

SOCKET WELDING WITH AN HAND-HELD WELDING MACHINE



SCAN TO SEE
INSTRUCTION VIDEO



1) Pipes and fittings are joined by termofusion at 260°C, with appropriate welding equipment provided by HELIROMA. Connect to power (220V) and wait until the green control light switches off. From that moment on you can start working.



2) Simultaneously, warm up the entire depth of the pipe and the end of the fitting with the polywelder, applying slight pressure. Once the heating period has finished, join the pieces without interruptions.



3) During a short period of time - 3s, you may readjust the welded parts (do not rotate over 30°). A few minutes later, the fusion will reach its maximum strength.

SOCKET WELDING WITH AN HAND-HELD WELDING MACHINE - TIMES

NOMINAL DIAMETER	WELDING DEPTH	HEATING TIME	HANDLING TIME	COOLING TIME
(mm)		(s)		(min)
20	14,5	5	4	2
25	16	7	4	2
32	18	8	6	4
40	20,5	12	6	4
50	23,5	18	6	4
63	27,5	24	8	6
75	31	30	8	8
90	35,5	40	8	8
110	41,5	50	10	8
125	40	70	12	10

Note: heating time starts when the pipe and fitting are correctly positioned over the welding bushes.

SOCKET WELDING WITH A STATIONARY WELDING MACHINE

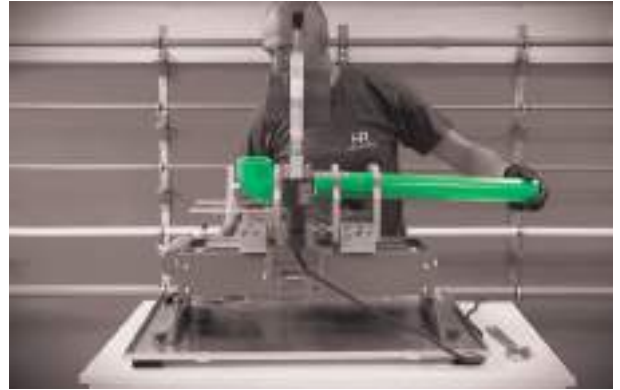

SCAN TO SEE
INSTRUCTION VIDEO



1) Check the machine procedure: temperature check - 260°C, adjust clamping jaws according to the size needed and adjust machine size selector according to the size to be welded.

2) Fix the fitting properly against the clamping jaws as well as the pipe (specific jaw for each pipe and fitting). Note: when pipe and fittings are pressed by the jaws it should not create ovality either on the pipe or fitting.

3) Position the welding device centrally to the pipe-fitting axis and remove it.

4) In this position, push the pipe against the fitting and fix it with the clamping jaws.

5) Adjust the welding time according to the recommendations on Table (Socket Welding with a Hand-Held Welding), place the welding device and push the fitting and pipe slowly as far as they will go up to the marking.

6) The heating time starts when the pipe and fitting are completely pushed on the tool. When heating time is complete, remove the heating device quickly and join the pipe and fitting.

7) Consider cooling times.

BUTT WELDING PROCESS



SCAN TO SEE
INSTRUCTION VIDEO

PIPE DIMENSION ≥ 160 mm

- 1) Make sure the machine and all its components are working properly;
- 2) Place the machine in position on a flat surface to ensure its stability;
- 3) Place the fixed part on the first pipe (1st and 2nd jaws) or fitting (1st jaw) and secure it with the jaw/s;
- 4) Move the entire set forward, ensuring that there is enough space to place the rectifier between the two ends of the pipe, or pipe and fittings;
- 5) Insert the second pipe and tighten the jaws (3rd and 4th jaws, or 2nd, 3rd and 4th jaws, if there is a fitting in the 1st jaw), until a perfect confrontation and alignment of the ends is achieved;
- 6) Join the ends of the pipe/pipe or pipe/fitting at the limit of the rectifier, using the bench handle;
- 7) Rectify the pipe perimeter until a continuous tape is obtained on both sides. In this way, any defects are eliminated and a surface free of oxidised waste material is achieved, ensuring that both ends are perfectly parallel;
- 8) Remove the rectifier and tape, avoiding any contact with the rectified area. Ensure parallelism and alignment (maximum tolerance is 10% of the pipe's thickness);
- 9) Clean the surface of the heating plate with a cloth soaked in a degreasing solution;
- 10) Check the polywelder temperature on the display ($210^{\circ}\text{C} \pm 10^{\circ}\text{C}$);
- 11) Set the correct temperature for the polywelder, on the bench structure;
- 12) Bring the ends of the pipe/pipe or pipe/fitting close to the heating plate;
- 13) Put the group under pressure until reaching pressure X1 and ensuring that the ends of the pipe form a uniform joint with the Y height around the entire perimeter. After reaching the intended height, maintain the polywelder at pressure X2, during Z1 seconds. (see values on table 16 or 17);
- 14) Reduce the pressure and separate the ends from the polywelder;
- 15) Remove the polywelder and quickly join the parts (see maximum manipulation time – Z2). Place group at pressure X3 during time period Z3. The system should not be submitted to any mechanical stress during time period Z4. (see values on table 16 or 17);
- 16) After the cooling time, reduce muzzle pressure and proceed with the next welding.

PP-R 100 WITH FIBERGLASS SDR 7,4 | S 3.2 (MACHINE: OMISA SP 250 EVO - SP 315 EVO)

NOMINAL DIAMETER	ADJUSTMENT		HEAT			WELDING		COOLING	
	PRESSURE P ₁ *	BURR HEIGHT Y	PRESSURE P ₂	TIME T ₂		MAXIMUM MANIPULATION TIME T ₃	CONTACT TIME T ₄	PRESSURE P ₅ *	TIME T ₅
(mm)	(bar)	(mm)	(bar)	(s)	(min : s)	(s)	(s)	(bar)	(min)
160	19	1,5	1,5	360	06:00	10	19	22	34
200	29	2	2,9	410	06:50	11	23	27	42
250	45	2	4,5	460	07:40	13	29	34	51

PP-R 100 WITH FIBERGLASS SDR 11 | S 5.0 (MACHINE: OMISA SP 250 EVO - SP 315 EVO)

NOMINAL DIAMETER	ADJUSTMENT		HEAT			WELDING		COOLING	
	PRESSURE P ₁ *	BURR HEIGHT Y	PRESSURE P ₂	TIME T ₂		MAXIMUM MANIPULATION TIME T ₃	CONTACT TIME T ₄	PRESSURE P ₅ *	TIME T ₅
(mm)	(bar)	(mm)	(bar)	(s)	(min : s)	(s)	(s)	(bar)	(min)
160	13	1	1,3	280	04:40	8	13	13	24
200	21	1	2	330	05:30	9	16	20	29
250	32	1,5	3,2	370	06:10	10	20	32	35
315	50	2	5	420	07:00	12	24	50	44

PP-RCT 125 WITH FIBERGLASS SDR 11 | S 5.0 (MACHINE: OMISA SP 250 EVO - SP 315 EVO)

NOMINAL DIAMETER	ADJUSTMENT		HEAT			WELDING		COOLING	
	PRESSURE P ₁ *	BURR HEIGHT Y	PRESSURE P ₂	TIME T ₂		MAXIMUM MANIPULATION TIME T ₃	CONTACT TIME T ₄	PRESSURE P ₅ *	TIME T ₅
(mm)	(bar)	(mm)	(bar)	(s)	(min : s)	(s)	(s)	(bar)	(min)
160	13	1	1,3	280	04:40	8	13	13	24
200	21	1	2	330	05:30	9	16	20	29
250	32	1,5	3,2	370	06:10	10	20	32	35

PP-RCT 125 WITH FIBERGLASS SDR 17 | S 8.0 (MACHINE: OMISA SP 250 EVO - SP 315 EVO)

NOMINAL DIAMETER	ADJUSTMENT		HEAT			WELDING		COOLING	
	PRESSURE P ₁ *	BURR HEIGHT Y	PRESSURE P ₂	TIME T ₂		MAXIMUM MANIPULATION TIME T ₃	CONTACT TIME T ₄	PRESSURE P ₅ *	TIME T ₅
(mm)	(bar)	(mm)	(bar)	(s)	(min : s)	(s)	(s)	(bar)	(min)
160	9	1	0,9	210	03:30	7	9	9	16
200	14	1	1,4	250	04:10	7	11	14	20
250	21	1	2,1	285	04:45	8	13	21	24
315	34	1	3,4	340	05:40	9	17	34	30

* Add to this value the previously calculated drag pressure (P_t) value.

Note: the above parameters are only reference values, not guaranteed values! The values are extrapolated from the standards (DVS 2207/11 /12-208) to the PP.

PP-R 100 WITH FIBERGLASS SDR 7,4 | S 3.2 (MACHINE: OMISA SP 500 EVO - SP 630 EVO)

NOMINAL DIAMETER	ADJUSTMENT		HEAT			WELDING		COOLING	
	PRESSURE P_1^*	BURR HEIGHT Y	PRESSURE P_2	TIME T_2		MAXIMUM MANIPULATION TIME T_3	CONTACT TIME T_4	PRESSURE P_5^*	TIME T_5
(mm)	(bar)	(mm)	(bar)	(s)	(min : s)	(s)	(s)	(bar)	(min)
200	11	2	1,1	410	06:50	11	23	11	42
250	17	2	1,6	460	07:40	13	29	17	51

PP-R 100 WITH FIBERGLASS SDR 11 | S 5.0 (MACHINE: OMISA SP 500 EVO - SP 630 EVO)

NOMINAL DIAMETER	ADJUSTMENT		HEAT			WELDING		COOLING	
	PRESSURE P_1^*	BURR HEIGHT Y	PRESSURE P_2	TIME T_2		MAXIMUM MANIPULATION TIME T_3	CONTACT TIME T_4	PRESSURE P_5^*	TIME T_5
(mm)	(bar)	(mm)	(bar)	(s)	(min : s)	(s)	(s)	(bar)	(min)
200	8	1	0,7	330	05:30	9	16	8	29
250	12	1,5	1,1	370	06:10	10	20	12	35
315	18	2	1,8	420	07:00	12	24	18	44
355	23	2	2,3	450	07:30	12	28	23	49
400	29	2	2,9	480	08:00	14	31	30	54

PP-RCT 125 WITH FIBERGLASS SDR 11 | S 5.0 (MACHINE: OMISA SP 500 EVO - SP 630 EVO)

NOMINAL DIAMETER	ADJUSTMENT		HEAT			WELDING		COOLING	
	PRESSURE P_1^*	BURR HEIGHT Y	PRESSURE P_2	TIME T_2		MAXIMUM MANIPULATION TIME T_3	CONTACT TIME T_4	PRESSURE P_5^*	TIME T_5
(mm)	(bar)	(mm)	(bar)	(s)	(min : s)	(s)	(s)	(bar)	(min)
200	8	1	0,7	330	05:30	9	16	8	29
250	12	1,5	1,1	370	06:10	10	20	12	35

PP-RCT 125 WITH FIBERGLASS SDR 17 | S 8.0 (MACHINE: OMISA SP 500 EVO - SP 630 EVO)

NOMINAL DIAMETER	ADJUSTMENT		HEAT			WELDING		COOLING	
	PRESSURE P_1^*	BURR HEIGHT Y	PRESSURE P_2	TIME T_2		MAXIMUM MANIPULATION TIME T_3	CONTACT TIME T_4	PRESSURE P_5^*	TIME T_5
(mm)	(bar)	(mm)	(bar)	(s)	(min : s)	(s)	(s)	(bar)	(min)
200	5	1	0,5	250	04:10	7	11	5	20
250	8	1	0,8	285	04:45	8	13	8	24
315	12	1	1,2	340	05:40	9	17	12	30
355	16	1,5	1,6	350	05:50	10	19	16	33
400	20	1,5	2	380	06:20	10	20	20	37

* Add to this value the previously calculated drag pressure (P_t) value.

Note: the above parameters are only reference values, not guaranteed values! The values are extrapolated from the standards (DVS 2207/11 /12-208) to the PP.

WELD-ON SADDLE

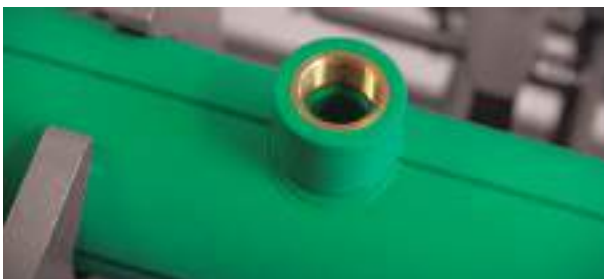

SCAN TO SEE
INSTRUCTION VIDEO

1) The first step is to drill through the pipe wall at the intended outlet point by using the drill tool referenced in HELIROMA range of products.

2) Remove burrs or other debris from the pipe welding area.

3) The welding device / saddle welding tool must have reached the required operating temperature of 260°C.

4) The welding surfaces have to be clean and dry before starting the welding process.

5) Insert the heating tool on the concave side of the weld-in saddle tool into the hole drilled in the pipe wall until the tool is fully in contact with the outer wall of the pipe.

6) Start inserting the fitting into the heating tool until the end and start counting the heating time.

7) After the welding tool has been removed, the weld-in saddle is immediately inserted into the heated, drilled hole. Then the fitting should be pressed on the pipe for about 15 seconds.

8) After cooling for 10 minutes the connection can be exposed to its full loading.

SOCKET WELDING WITH AN ELECTRIC MACHINE



SCAN TO SEE
INSTRUCTION VIDEO

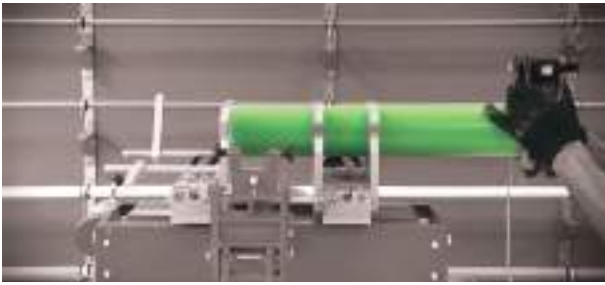

1) Make sure the machine and scraper are working properly.



2) Place the scraper on a flat surface to ensure its stability.



3) Insert the pipe in the scraper, ensuring that the scraper blade is placed facing the pipe.



4) Adjust the handle that allows the diameter and blade handle to be defined until they are tightly fitted to the pipe;

5) Check the depth of the fitting and mark the same length on the pipe in order to ensure that scraping does not exceed your needs;

6) Start the scraping process, rotating the scraper in circular movements (clockwise) until a homogeneous thick "tape" is obtained. Continue the process until you reach the mark previously made on the pipe;



7) Upon completion, insert the pipe until reaching the catch inside the pipe;

8) After the pipe/s has/have been properly inserted in the fitting, switch the electro-welding machine on (IMPORTANT: ensure constant current charge); switch on machine button (ON/OFF) and place the terminals on the fitting;



9) Check necessary welding time according to the fitting to be used, see label on the fitting.

10) Set the necessary welding time on display by pressing the (+) and (-) button until the intended time is set;

11) Start welding process, press OK button, and start countdown of the pre-set time;

12) When the countdown has finished, the machine will beep and the display will show the same message (Prn), which means that the welding is finished. We can confirm the protruding pivots of the fittings;

13) Remove the fitting's terminals and start a new electro-welding process if necessary. (e.g. 90° bend of 110-250 seconds).

FLANGED CONNECTIONS

The connection between systems with flanges must be done with the sealing surface always aligned and parallel to each other. All materials must be clean and undamaged.

The tightening of flange connections immediately after welding must be avoided.

The screw length should be selected so that screw thread is as flush as possible, until two threads from nut. To distribute the force of the screw head and the nut over a large area, washers can be used.

Along the connection seal, the screw joints must be tightened diagonally and evenly. To connections exposed to a mutual load, all screw joint must be verified and retightened, if necessary.



PIPE REPAIR WITH REPAIR PIN

Damaged pipes may be repaired by means of pipe repair pin. To that operation is necessary the welding tool, a repair bush and a polywelder.

The processing steps are:

- 1) Drain pipe, the surface must be dry;
- 2) Uncover damaged pipe;
- 3) Drill damaged area of pipe out to a correct diameter (7 mm or 11 mm) at a right angle to the pipe;
- 4) Heat up drill hole and repair stick on the welding machine for 10 seconds;
- 5) Insert repair stick immediately;
- 6) Cut off protruding end of repair stick;
- 7) The repaired area of pipe has reached full strength after approximately 5 minutes.



SYSTEM FEATURES

All HELIROMA pipes and fittings are produced with the best quality raw material, purchased from the most qualified providers on the market, the polypropylene copolymer random PP-R 100 or the Polypropylene copolymer Random with modified crystallinity–PP-RCT 125. A heat stabilized raw material that gives a much higher safety factor on piping. An opaque system with no danger of algae development.

The connections in HELIROMA's piping system are made using socket welding, butt fusion, and electrofusion, all are a simple process which actually turns the pipe and fitting into a single piece. The homogeneous connection that is chemically indistinguishable from the rest of the material, there are no solvents, glues or different connection, eliminating weak points and harmful chemicals from the system. The heat fusion joints maintain the same properties as the pipe itself, so physical stresses will not damage their integrity.



The extrapolated service life of HELIROMA PP-R systems is more than 50 years. Punctual operation temperature of 100°C, are admissible, continuous operation from 70-90°C reduce the life expectancy of the system.

HELIROMA systems can be used for several applications, the pressure and temperature conditions according to table – Permissible working pressure, are valid, ever apply the recommended safety factor. HELIROMA systems have a high performance which last longer with less maintenance, adding value to each installation.

The experience in production and application of PP-R systems and the current ambition of continuous development led HELIROMA to numerous improvements of production process and products. PP-R systems meet the highest requirements of a global market in the potable water and heating technology, in the air-conditioning and chilling engineering, in the industrial and agriculture applications, as well in shipbuilding.



APPLICATION - POTABLE WATER INSTALLATIONS

Potable water is one of the most controlled commodity goods. The choice of a drinkable water pipe system and its material is utterly important.

PP-R is a hydrophobic low-friction material, meaning that it repels polarized compounds including water. PP-R systems are the perfect fit for drinkable water installations. It does not corrode or erode and will not leach into the water supply.

Choosing a material that does not react or interact with water or other fluids ensures that chemicals from the pipe and fittings will never transfer to drinking water.

The growing use of pipes made of polypropylene in drinkable water applications confirm the highly hygienic qualities of the material as well as its physiologically and microbiologically neutrality.

PP-R solutions from HELIROMA are the optimal solution for drinking water applications, the hygienic suitability of the material is independently verified through tests done from several accredited national and international entities.



APPLICATION - SPECIFIC ENGINEERING

All PP-R pipes from HELIROMA are engineered for optimal performance to a wide variety of applications.

HELIROMA successfully developed solutions with different structures and raw materials, that meet the different and growing demand of new markets and applications.

HELIROMA's solutions allow to optimize efficiency and economics of the installation with a higher safety factor.

SOUND INSULATION

PP-R systems provide good sound insulation. Sound propagation is much lower compared to metallic systems.

CORROSION RESISTANCE

HELIROMA's PP-R 100 and PP-RCT 125 are raw materials very resistant to any form of change of the material wall. While other kind of piping material lose performance due scaling and corrosion.

HELIROMA piping, even after long use, retains its original flow performance and efficiency.

Corrosion can reduce the wall thickness of a metal pipe around 3% year, resulting in lost efficiency and increased pumping energy. This can add up the installation costs significantly.

HELIROMA pipes don't corrode or scale, so they continue delivering high efficiency and performance year after year.

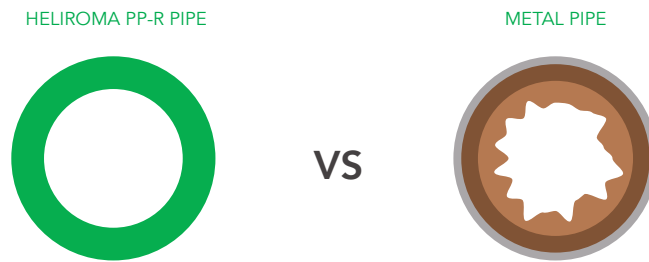

FULL SYSTEM RANGE

HELIROMA piping systems can be used in nearly any pressure application and range in size from 20 to 400 mm. This allows installers to use one type of pipe for an entire system rather than mixing multiple materials and joining methods.

An entire project can be done using Heliroma pipes, eliminating the need for multiple tools sets and maintenance programs.

Transitions with flanges or threaded fittings make combining Heliroma pipe with other systems and components in a simple and easy way.

All systems from PP-R Heliroma family, can be combined on installations, PP-R 100 SDR 6 and SDR 7,4 - HELISYSTEM, PP-R 100 + FG SDR 7,4 - ROMAFASER PP-R 100 + FG SDR 11 – ROMA KLIMA, PP-RCT 125 + FG SDR 11– ROMAFASER CT PP-RCT 125 + FG SDR 17 – ROMA KLIMA CT.

SUSTAINABILITY

HELIROMA is a company future-oriented that has its production process and products aligned with sustainability and energy efficiency guidelines and best practices, fulfilling all ecological and environmental standards.

All raw materials used on the production of pipes and fittings are controlled with several tests in different laboratories to ensure that nothing harmful is ever put into our final product.

Pipes and fittings made of polypropylene have a service life of more than 50 years, rarely need maintenance or extensive reparations, it does not generate disposal waste.

Furthermore, polypropylene is an environmentally friendly material, fully recyclable and can be re-used in other applications on different areas.

WARRANTY

All supplied products by Heliroma installed according all procedures in Heliroma catalogue, have 10 years warranty against manufacturing defects.

For further information, consult the general terms and conditions.

PERMISSIBLE WORKING PRESSURE - PP-R 100

Non potable water applications - heating systems or closed systems

TEMPERATURE (°C)	PERMISSIBLE WORKING PRESSURE (bar)		
	LIFETIME (years)	HELISYSTEM P-R 100 SDR 6 S2.5	HELISYSTEM PP-R 100 SDR 7,4 S3.2
10	1	42,1	33,4
	5	39,7	31,5
	10	38,6	30,7
	25	37,4	29,7
	50	36,4	28,9
20	1	35,9	28,5
	5	33,7	26,8
	10	32,8	26,1
	25	31,7	25,2
	50	30,9	24,5
30	1	30,5	24,2
	5	28,6	22,7
	10	27,8	22,1
	25	26,8	21,3
	50	26,1	20,7
40	1	25,9	20,6
	5	24,2	19,2
	10	23,5	18,7
	25	22,6	18
	50	22	17,4
50	1	21,9	17,4
	5	20,4	16,2
	10	19,8	15,6
	25	19	15,1
	50	18,5	14,7
60	1	18,5	14,7
	5	17,2	13,6
	10	16,6	13,2
	25	16	12,7
	50	15,5	12,3

CONTINUED >

CONTINUED >

TEMPERATURE (°C)	PERMISSIBLE WORKING PRESSURE (bar)		
	LIFETIME (years)	HELISYSTEM P-R 100 SDR 6 S2.5	HELISYSTEM PP-R 100 SDR 7,4 S3.2
70	1	15,5	12,3
	5	14,4	11,4
	10	13,9	11,1
	25	12,1	9,6
	50	10,2	8,1
80	1	13	10,3
	5	11,5	9,1
	10	9,7	7,7
	25	7,8	6,2
95	1	9,2	7,3
	5	6,2	4,9

Safety factor - 1,25.

The referenced service lifetime does not consider installation changes, such as: high concentration of disinfection agents, metallic materials out of specification, neither operating temperature and/or pressure malfunctions.

For sanitary water installations, working pressures should be reduced by 15%, for the same service lifetime. The maximum allowable temperature is 70°C, which corresponds to thermal disinfection temperature and not to continuous operating temperature. Disinfection processes should be carried out according to mandatory regulations and under no circumstance a combination of different processes should be used.

In case of butt-welded pipes and/or fittings, allowable operating pressures should be reduced by 25%.

PERMISSIBLE WORKING PRESSURE - PP-R 100 + FG

Potable water applications - open systems in permanent operation

TEMPERATURE (°C)	PERMISSIBLE WORKING PRESSURE (bar)		
	LIFETIME (years)	ROMAFASER PP-R 100 + FG SDR 7,4 S3.2	ROMAKLIMA PP-R 100 + FG SDR 11 S5.0
20	1	28,6	23,8
	5	26,8	22,3
	10	26,1	21,7
	25	25,3	21,0
	50	24,5	20,4
30	1	24,3	20,2
	5	22,8	18,9
	10	22,0	18,4
	25	21,3	17,8
	50	20,7	17,3
40	1	20,5	17,1
	5	19,2	16,0
	10	18,7	15,6
	25	18,0	15,0
	50	17,5	14,6
50	1	17,5	14,5
	5	16,2	13,5
	10	15,7	13,1
	25	15,2	12,6
	50	14,7	12,2
60	1	12,2	13,5
	5	11,4	13
	10	11	12,7
	25	10,6	12,4
	50	10,3	12,2
70	1	12,4	10,3
	5	11,4	9,6
	10	11,1	9,2
	25	9,6	8,0
	50	8,1	6,8

Safety factor - 1,5.

The referenced service lifetime does not consider installation changes, such as: high concentration of disinfection agents, metallic materials out of specification, neither operating temperature and/or pressure malfunctions.

For sanitary water installations, working pressures should be reduced by 15%, for the same service lifetime. The maximum allowable temperature is 70°C, which corresponds to thermal disinfection temperature and not to continuous operating temperature. Disinfection processes should be carried out according to mandatory regulations and under no circumstance a combination of different processes should be used.

In case of butt-welded pipes and/or fittings, allowable operating pressures should be reduced by 25%.

PERMISSIBLE WORKING PRESSURE - PP-RCT 125 + FG

Potable water applications - open systems in permanent operation

TEMPERATURE °C	PERMISSIBLE WORKING PRESSURE (bar)		
	LIFETIME (years)	ROMAFASER CT PP-RCT 125 + FG SDR 11 S5.0	ROMAKLIMA CT PP-RCT 125 + FG SDR 17 S8.0
20	1	25,0	12,5
	5	24,2	12,1
	10	23,9	12,0
	25	23,5	11,7
	50	23,1	11,6
30	1	21,7	10,8
	5	20,9	10,5
	10	20,6	10,3
	25	20,2	10,1
	50	19,9	10,0
40	1	18,6	10,6
	5	18,0	10,5
	10	17,7	10,2
	25	17,3	10,2
	50	17,1	10,0
50	1	15,9	9,4
	5	15,3	9,3
	10	15,1	9,3
	25	14,7	8,7
	50	14,5	8,6
60	1	8,1	8,1
	5	7,9	7,9
	10	7,5	7,5
	25	7,4	7,4
	50	7,3	7,3
70	1	11,3	7,3
	5	10,9	7,2
	10	10,7	7,2
	25	10,4	7,1
	50	10,2	7,0

Safety factor - 1,5.

The referenced service lifetime does not consider installation changes, such as: high concentration of disinfection agents, metallic materials out of specification, neither operating temperature and/or pressure malfunctions.

For sanitary water installations, working pressures should be reduced by 15%, for the same service lifetime. The maximum allowable temperature is 70°C, which corresponds to thermal disinfection temperature and not to continuous operating temperature. Disinfection processes should be carried out according to mandatory regulations and under no circumstance a combination of different processes should be used.

In case of butt-welded pipes and/or fittings, allowable operating pressures should be reduced by 25%.

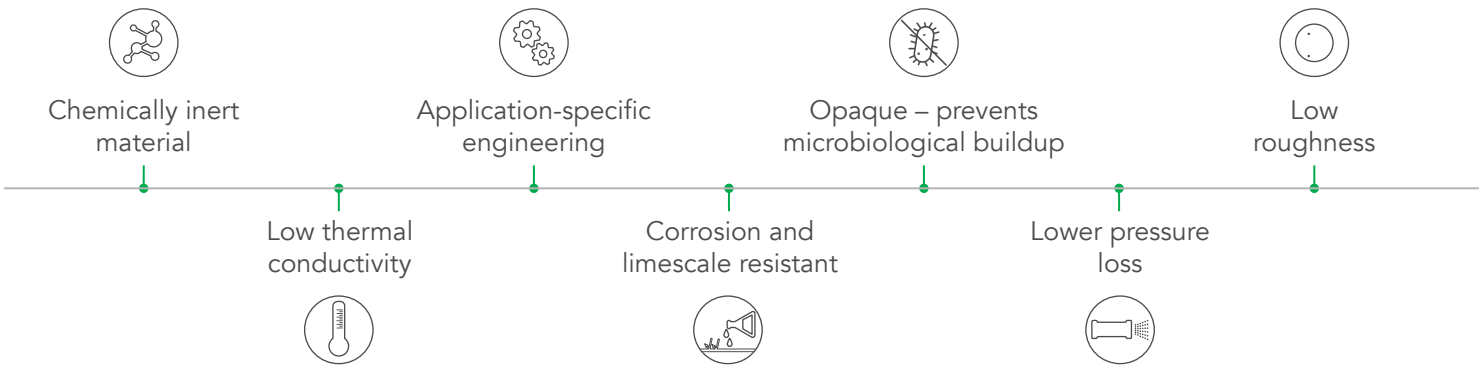

SYSTEM GENERAL ADVANTAGES

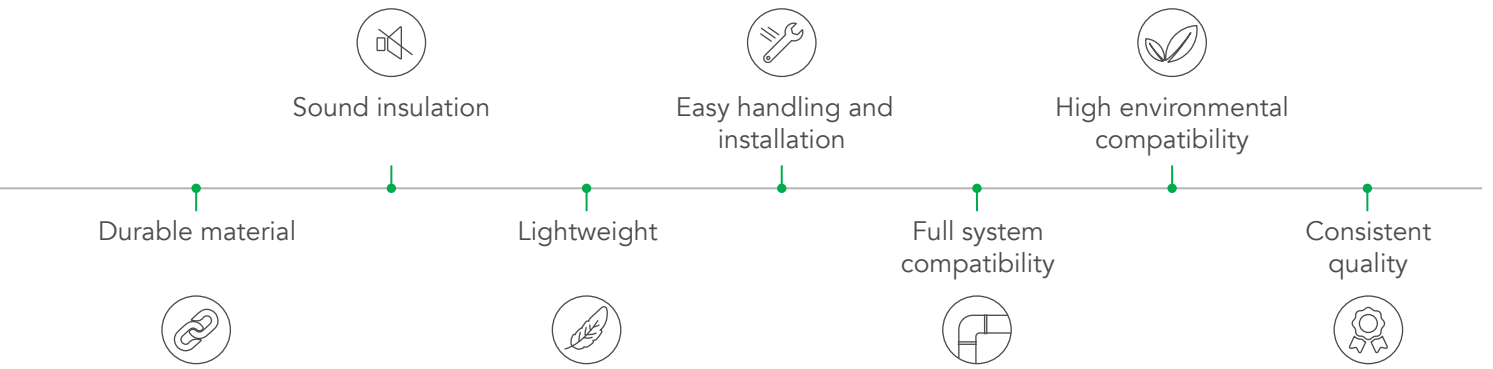

CERTIFICATIONS

HELIROMA piping systems comply with the following national and international standards and regulations.

The high resilience of PP-R systems is checked regularly through several tests during the production and at laboratory.

STANDARDS:

EN 15874-1: Plastics piping systems for hot and cold water installations - Polypropylene (PP). - General.

EN 15874-2: Plastics piping systems for hot and cold water installations - Polypropylene (PP). - Pipes.

EN 15874-3: Plastics piping systems for hot and cold water installations - Polypropylene (PP). – Fittings.

EN 15874-5: Plastics piping systems for hot and cold water installations - polypropylene (PP) - fitness for purpose of the system.

EN 15874-7: Plastics piping systems for hot and cold water installations - polypropylene (PP) - guidance for the assessment of conformity (technical specification).

DIN 8077: Polypropylene (PP) pipes - Dimensions.

DIN 8078: Polypropylene (PP) pipes - General quality requirements and testing.

ASTM F2389: Standard Specification for Pressure-rated Polypropylene (PP) Piping Systems.

DIN 16962: Pipe fittings and joint assemblies for polypropylene (PP) pressure pipes.

DIN EN1092: Flanges and their joints - Circular flanges for pipes, valves, fittings and accessories, PN designated - Part 1: Steel flanges.

ISO 15494:2015: Plastics piping systems for industrial applications — Polybutene (PB), polyethylene (PE), polyethylene of raised temperature resistance (PE-RT), crosslinked polyethylene (PE-X), polypropylene (PP) — Metric series for specifications for components and the system.

RP 01.16: Specific rules for polypropylene (PP) systems for hot and cold water installations.

RP 01.72: Specific rules for polypropylene (PP-R) and fiberglass (GF) piping systems for hot and cold water installations inside buildings.

RP 01.78: Specific rules for polypropylene random with modified crystal structure (PP-RCT) and fiberglass (FG) piping systems for hot and cold water installations inside buildings.

W544: Plastic pipes in the drinking water installation -requirements and testing.

EN ISO 9001: Quality management systems: requirements.



ICECON[®]S.A.

DITEC

PP-R | PRODUCT RANGE

- PP-R PIPES
- PP-R FITTINGS
- ELECTROFUSION FITTINGS
- FITTINGS FOR ELECTROFUSION
- PP-R TOOLS

PP-R 100 PIPE SDR 6 HELISYSTEM

PP-R 100

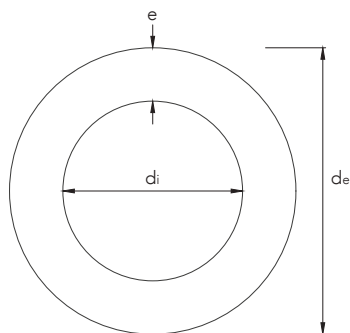
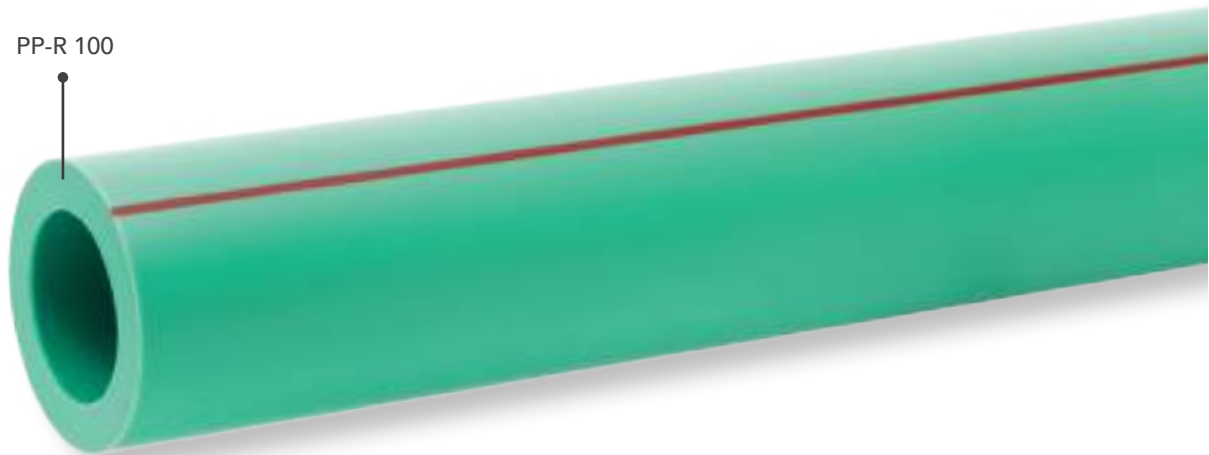

CHARACTERISTICS

SUPPLIED IN	4 m bars
TYPE OF WELDING	Socket Electrofusion Butt Welding
SERIES	2.5
STANDARDS	EN ISO 15874 DIN 8077 DIN 8078 DIN 16962 ASTM F 2389 RP 0116



REFERENCE	d _n NOMINAL DIAMETER	d _e OUTSIDE DIAMETER		e THICKNESS		d _i INSIDE DIAMETER		WEIGHT (kg/m)	MAX WEIGHT W/ WATER *	COLOUR	
		Min.	Max.	Min.	Max.	Min.	Max.			●	●
P-16020	20	20,0	20,3	3,4	3,9	12,2	13,5	0,175	0,318	✓	✓
P-16025	25	25,0	25,3	4,2	4,8	15,4	16,9	0,266	0,490	✓	✓
P-16032	32	32,0	32,3	5,4	6,1	19,8	21,5	0,438	0,801	✓	✓
P-16040	40	40,0	40,4	6,7	7,5	25,0	27,0	0,678	1,251	✓	✓
P-16050	50	50,0	50,5	8,3	9,3	31,4	33,9	1,036	1,939	✓	✓
P-16063	63	63,0	63,6	10,5	11,7	39,6	42,6	1,638	3,063	✓	✓
P-16075	75	75,0	75,7	12,5	13,9	47,2	50,7	2,340	4,359	✓	✓
P-16090	90	90,0	90,9	15,0	16,6	56,8	60,9	3,353	6,266	✓	✓
P-160110	110	110,0	111,0	18,3	20,3	69,4	74,4	4,900	9,247	✓	✓

* Water max. weight calculated with ρ_{H₂O} at 4°C;

PP-R 100 PIPE SDR 7,4 HELISYSTEM

PP-R 100

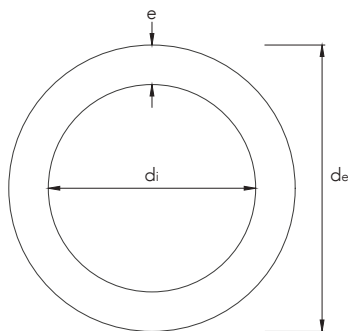
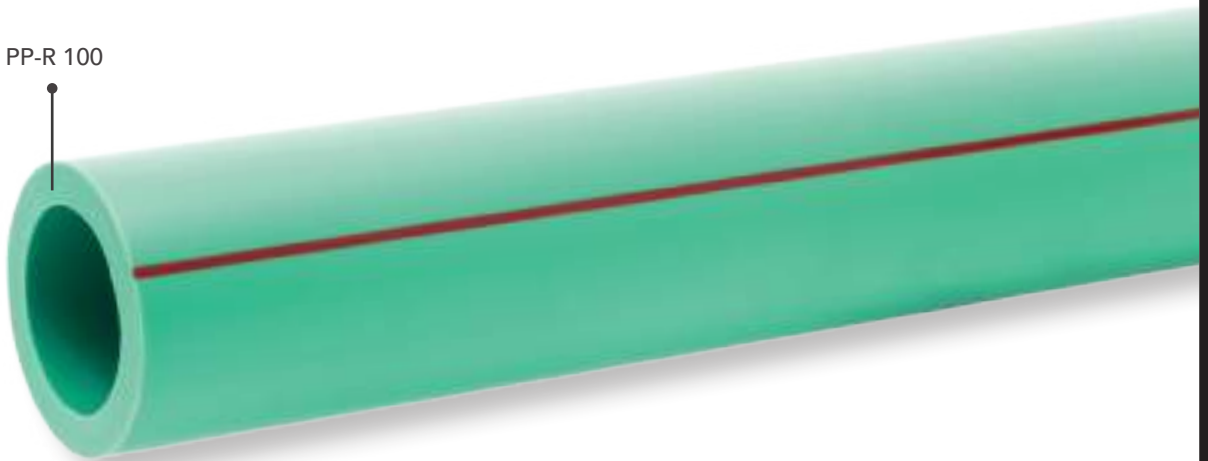

CHARACTERISTICS

SUPPLIED IN	4 m bars
TYPE OF WELDING	Socket Electrofusion Butt Welding
SERIES	3.2
STANDARDS	EN ISO 15874 DIN 8077 DIN 8078 DIN 16962 ASTM F 2389 RP 0116



REFERENCE	d _n NOMINAL DIAMETER	d _e OUTSIDE DIAMETER		e THICKNESS		d _i INSIDE DIAMETER		WEIGHT	MAX WEIGHT W/ WATER *	COLOUR 
		Min.	Max.	Min.	Max.	Min.	Max.			
		(mm)						(kg/m)		
P-15020	20	20,0	20,3	2,8	3,2	13,6	14,7	0,148	0,318	✓
P-15025	25	25,0	25,3	3,5	4,0	17,0	18,3	0,236	0,499	✓
P-15032	32	32,0	32,3	4,4	5,0	22,0	23,5	0,380	0,814	✓
P-15040	40	40,0	40,4	5,5	6,2	27,6	29,4	0,590	1,269	✓
P-15050	50	50,0	50,5	6,9	7,7	34,6	36,7	0,890	1,948	✓
P-15063	63	63,0	63,6	8,6	9,6	43,8	46,4	1,435	3,126	✓
P-15075	75	75,0	75,7	10,3	11,5	52,0	55,1	1,975	4,359	✓
P-15090	90	90,0	90,9	12,3	13,7	62,6	66,3	2,845	6,297	✓
P-150110	110	110,0	111,0	15,1	16,8	76,4	80,8	4,280	9,408	✓

* Water max. weight calculated with ρ_{H₂O} at 4°C;

PP-R 100 PIPE WITH FIBERGLASS SDR 7,4 ROMAFASER

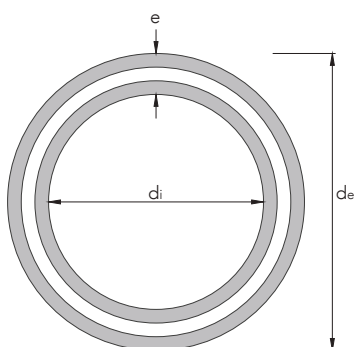
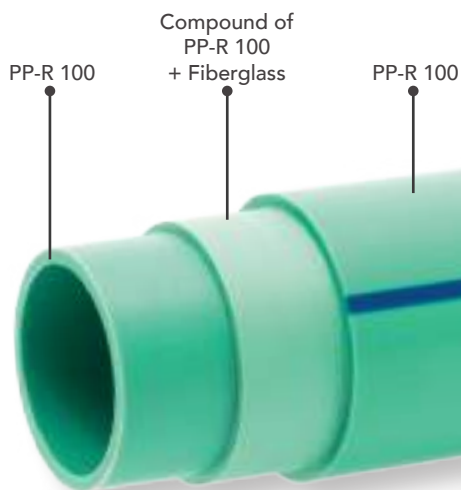

CHARACTERISTICS

SUPPLIED IN	4 m bars
TYPE OF WELDING	Socket Electrofusion Butt Welding
SERIES	3.2
STANDARDS	EN ISO 15874 DIN 8077 DIN 8078 DIN 16962 ASTM F 2389 RP 001.72



REFERENCE	d _n NOMINAL DIAMETER	d _e OUTSIDE DIAMETER		e THICKNESS		d _i INSIDE DIAMETER		WEIGHT (kg/m)	MAX WEIGHT W/ WATER *	COLOUR	
		Min.	Max.	Min.	Max.	Min.	Max.			●	●
P-16020-F	20	20,0	20,3	2,8	3,2	13,6	14,7	0,153	0,350	✓	✓
P-16025-F	25	25,0	25,3	3,5	4,0	17,0	18,3	0,246	0,509	✓	✓
P-16032-F	32	32,0	32,3	4,4	5,0	22,0	23,5	0,390	0,824	✓	✓
P-16040-F	40	40,0	40,4	5,5	6,2	27,6	29,4	0,600	1,279	✓	✓
P-16050-F	50	50,0	50,5	6,9	7,7	34,6	36,7	0,919	1,977	✓	✓
P-16063-F	63	63,0	63,6	8,6	9,6	43,8	46,4	1,433	3,124	✓	✓
P-16075-F	75	75,0	75,7	10,3	11,5	52,0	55,1	2,061	4,445	✓	✓
P-16090-F	90	90,0	90,9	12,3	13,7	62,6	66,3	2,933	6,385	✓	✓
P-160110-F	110	110,0	111,0	15,1	16,8	76,4	80,8	4,344	9,472	✓	✓

* Water max. weight calculated with ρ_{H₂O} at 4°C;

PP-R 100 PIPE WITH FIBERGLASS SDR 11 ROMA KLIMA

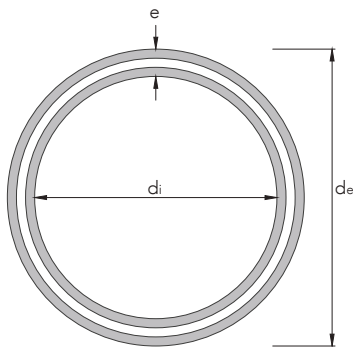
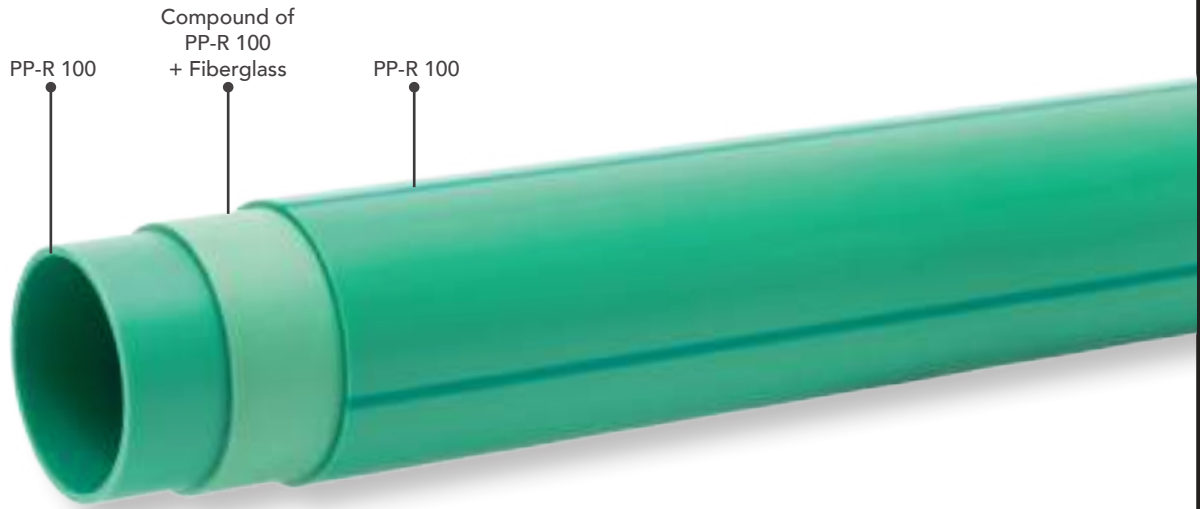

CHARACTERISTICS

SUPPLIED IN	4 m bars
TYPE OF WELDING	Socket Electrofusion Butt Welding
SERIES	5.0
STANDARDS	EN ISO 15874 DIN 8077 DIN 8078 DIN 16962 ASTM F 2389 RP 001.72



REFERENCE	d _n NOMINAL DIAMETER	d _e OUTSIDE DIAMETER		e THICKNESS		d _i INSIDE DIAMETER		WEIGHT	MAX WEIGHT W/ WATER *	COLOUR
		Min.	Max.	Min.	Max.	Min.	Max.			
								(mm)		(kg/m)
P-14020-FR	20 SDR 7,4	20,0	20,3	2,8	3,2	13,6	14,7	0,153	0,323	✓
P-14025-FR	25 SDR 7,4	25,0	25,3	3,5	4,0	17,0	18,3	0,246	0,509	✓
P-14032-FR	32	32,0	32,3	2,9	3,3	25,4	26,5	0,278	0,830	✓
P-14040-FR	40	40,0	40,4	3,7	4,2	31,6	33,0	0,422	1,277	✓
P-14050-FR	50	50,0	50,5	4,6	5,2	39,6	41,3	0,644	1,984	✓
P-14063-FR	63	63,0	63,6	5,8	6,5	50,0	52,0	1,034	3,158	✓
P-14075-FR	75	75,0	75,7	6,8	7,6	59,8	62,1	1,500	4,529	✓
P-14090-FR	90	90,0	90,9	8,2	9,2	71,6	74,5	2,200	6,559	✓
P-140110-FR	110	110,0	111,0	10,0	11,1	87,8	91,0	3,122	9,626	✓
P-140125-FR ⁽¹⁾	125	125,0	126,2	11,4	12,7	99,6	103,4	4,020	12,417	✓
P-140160-FR ⁽¹⁾	160	160,0	161,5	14,6	16,2	127,6	132,3	6,439	20,186	✓

⁽¹⁾ Limited to existing stock | * Water max. weight calculated with ρ_{H₂O} at 4°C;

PP-R 100 PIPE WITH FIBERGLASS SDR 7,4 ANTI-UV ROMAFASER ANTI-UV

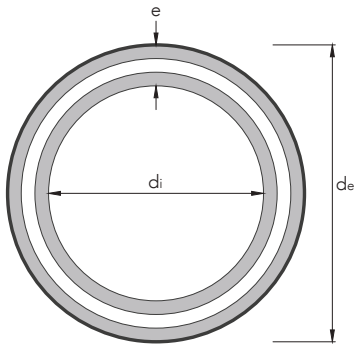
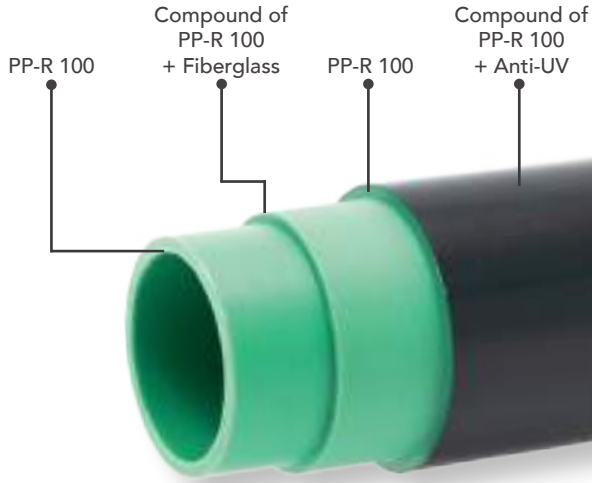

CHARACTERISTICS

SUPPLIED IN	4 m bars
TYPE OF WELDING	Socket Electrofusion Butt Welding
SERIES	3.2
STANDARDS	EN ISO 15874 DIN 8077 DIN 8078 DIN 16962 ASTM F 2389 RP 001.72



REFERENCE	d _n NOMINAL DIAMETER	d _e OUTSIDE DIAMETER		e THICKNESS		d _i INSIDE DIAMETER		WEIGHT	MAX WEIGHT W/ WATER *	COLOUR ○
		Min.	Max.	Min.	Max.	Min.	Max.			
		(mm)						(kg/m)		
P-16020-FUV	20	20,0	20,3	2,8	3,2	13,6	14,7	0,153	0,350	✓
P-16025-FUV	25	25,0	25,3	3,5	4,0	17,0	18,3	0,246	0,509	✓
P-16032-FUV	32	32,0	32,3	4,4	5,0	22,0	23,5	0,390	0,824	✓
P-16040-FUV	40	40,0	40,4	5,5	6,2	27,6	29,4	0,600	1,279	✓
P-16050-FUV	50	50,0	50,5	6,9	7,7	34,6	36,7	0,919	1,977	✓
P-16063-FUV	63	63,0	63,6	8,6	9,6	43,8	46,4	1,433	3,124	✓
P-16075-FUV	75	75,0	75,7	10,3	11,5	52,0	55,1	2,061	4,445	✓

* Water max. weight calculated with ρ_{H₂O} at 4°C;

PP-RCT 125 PIPE WITH FIBERGLASS SDR 11 ROMAFASER CT

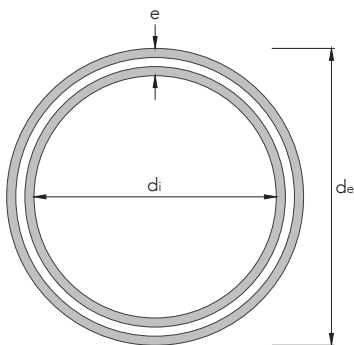
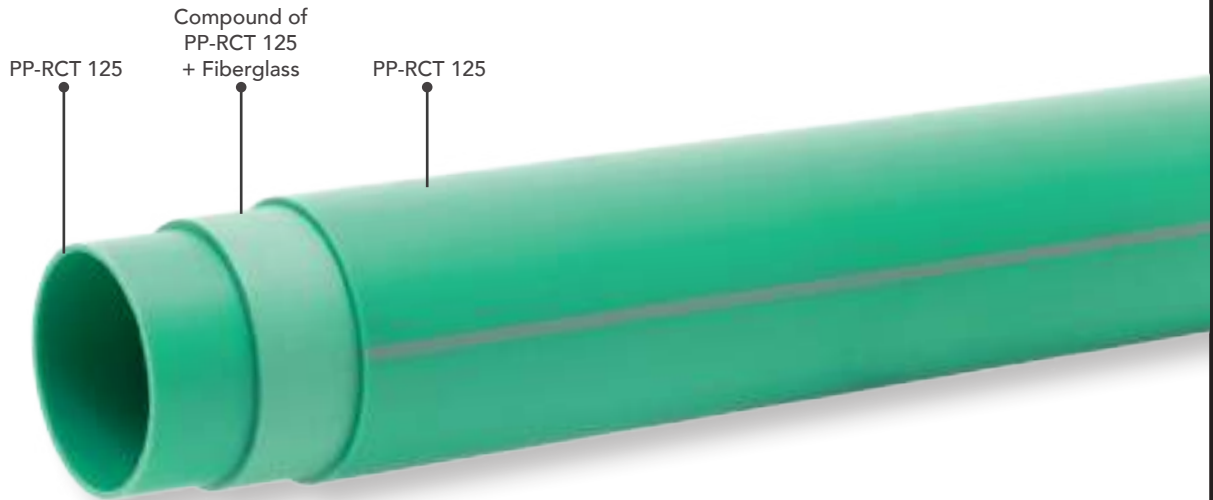

CHARACTERISTICS

SUPPLIED IN	∅ 20-125 mm - 4 m bars ∅ 160-250 mm - 5,8 m bars
TYPE OF WELDING	Socket Electrofusion Butt Welding
SERIES	5.0
STANDARDS	EN ISO 15874 DIN 8077 DIN 8078 DIN 16962 ASTM F 2389 RP 001.78



REFERENCE	d _n NOMINAL DIAMETER	d _e OUTSIDE DIAMETER		e THICKNESS		d _i INSIDE DIAMETER		WEIGHT	MAX WEIGHT W/ WATER *	COLOUR
		Min.	Max.	Min.	Max.	Min.	Max.			
		(mm)						(kg/m)		
P-16020-FCT	20 SDR 7,4	20,0	20,3	2,8	3,2	13,6	14,7	0,153	0,323	✓
P-16025-FCT	25 SDR 7,4	25,0	25,3	3,5	4,0	17,0	18,3	0,233	0,496	✓
P-16032-FCT	32 SDR 7,4	32,0	32,3	4,4	5,0	22,0	23,5	0,387	0,821	✓
P-16040-FCT	40	40,0	40,4	3,7	4,2	31,6	33,0	0,421	1,276	✓
P-16050-FCT	50	50,0	50,5	4,6	5,2	39,6	41,3	0,663	2,003	✓
P-16063-FCT	63	63,0	63,6	5,8	6,5	50,0	52,0	1,032	3,156	✓
P-16075-FCT	75	75,0	75,7	6,8	7,6	59,8	62,1	1,459	4,488	✓
P-16090-FCT	90	90,0	90,9	8,2	9,2	71,6	74,5	2,110	6,469	✓
P-160110-FCT	110	110,0	111	10,0	11,1	87,8	91,0	3,083	9,587	✓
P-160125-FCT	125	125,0	126,2	11,4	12,7	99,6	103,4	4,000	12,397	✓
P-160160-FCT	160	160,0	161,5	14,6	16,2	127,6	132,3	6,450	20,197	✓
P-160200-FCT	200	200,0	201,8	18,2	20,2	159,6	165,4	9,950	31,436	✓
P-160250-FCT	250	250,0	252,3	22,7	25,1	199,8	206,9	15,500	49,121	✓

* Water max. weight calculated with ρ_{H₂O} at 4°C;

PP-RCT 125 PIPE WITH FIBERGLASS SDR 17 ROMA KLIMA CT

PP-RCT 125
Compound of
PP-RCT 125
+ Fiberglass
PP-RCT 125

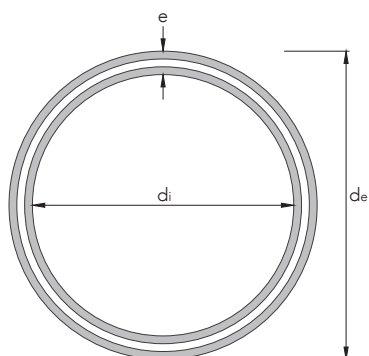
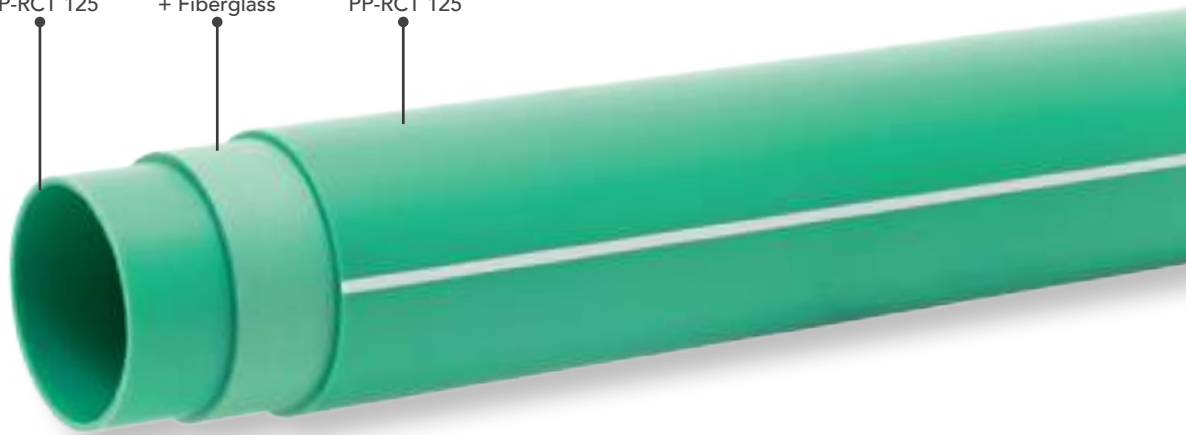

CHARACTERISTICS

SUPPLIED IN	ø 125 mm - 4 m bars ø 160-400 mm - 5,8 m bars
TYPE OF WELDING	Socket Electrofusion Butt Welding
SERIES	8.0
STANDARDS	EN ISO 15874 DIN 8077 DIN 8078 DIN 16962 ASTM F 2389 RP 001.78



REFERENCE	dn NOMINAL DIAMETER	de OUTSIDE DIAMETER		e THICKNESS		di INSIDE DIAMETER		WEIGHT (kg/m)	MAX WEIGHT W/ WATER *	COLOUR ●
		Min.	Max.	Min.	Max.	Min.	Max.			
P-140125-FRCT	125	125,0	126,2	7,4	8,3	108,4	111,4	2,750	12,497	✓
P-140160-FRCT	160	160,0	161,5	9,5	10,6	138,8	142,5	4,390	20,338	✓
P-140200-FRCT	200	200,0	201,8	11,9	13,2	173,6	178,0	6,853	31,738	✓
P-140250-FRCT	250	250,0	252,3	14,8	16,4	217,2	222,7	10,900	49,852	✓
P-140315-FRCT	315	315,0	317,5	18,7	20,7	273,6	280,1	16,750	78,369	✓
P-140355-FRCT	355	355,0	358,2	21,1	23,4	308,2	316,0	21,520	99,947	✓
P-140400-FRCT	400	400,0	403,6	23,7	26,2	347,6	356,2	27,300	126,950	✓

* Water max. weight calculated with ρ_{H_2O} at 4°C;



PP-R FITTINGS

ELBOW 45°



CHARACTERISTICS

COLOUR	Green Blue
RAW MATERIAL	PP-R 100 PP-RCT 125
TYPE OF WELDING	Socket
STANDARDS	EN ISO 15874 DIN 16962
COMPATIBLE SYSTEMS	HELISYSTEM ROMAFASER ROMAFASER ANTI-UV ROMAKLIMA ROMAFASER CT ROMAKLIMA CT

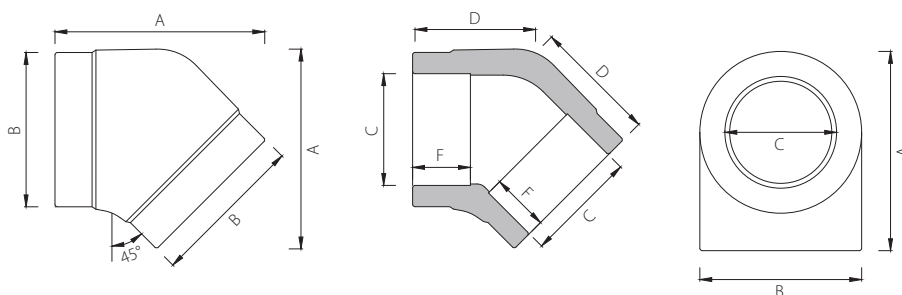

REFERENCE	DIAMETER	A	B	C min	D	F	WEIGHT	BAG	BOX	COLOUR	
										●	●
							(mm)	(kg)	(un)		
P-CT202020	20	48	27	19,2	26	15	0,013	50	400	✓	✓
P-CT202025	25	55	35	24,2	29	16	0,019	25	250	✓	✓
P-CT202032	32	67	42	31,1	36	18	0,036	10	120	✓	✓
P-202040	40	70	52	39	40	21	0,057	5	80	✓	✓
P-202050	50	85	65	48,9	44	24	0,092	4	40	✓	✓
P-202063	63	97	82	61,9	53	28	0,172	2	20	✓	✓
P-202075	75	130	101	73,7	68	31	0,328	2	12	✓	✓
P-202090	90	150	122	88,6	79	37	0,529	1	6	✓	✓
P-2020110	110	179	144	108,4	92	42	0,841	1	4	✓	✓
P-2020125	125	209	162	122,4	110	40	1,380	1	4	✓	

ELBOW 45° XL



CHARACTERISTICS

COLOUR	Green
RAW MATERIAL	PP-R 100 PP-RCT 125
TYPE OF WELDING	Butt Welding Electrofusion
STANDARDS	EN ISO 15874 DIN 16962
COMPATIBLE SYSTEMS	ROMAFASER ROMAKLIMA ROMAFASER CT ROMAKLIMA CT

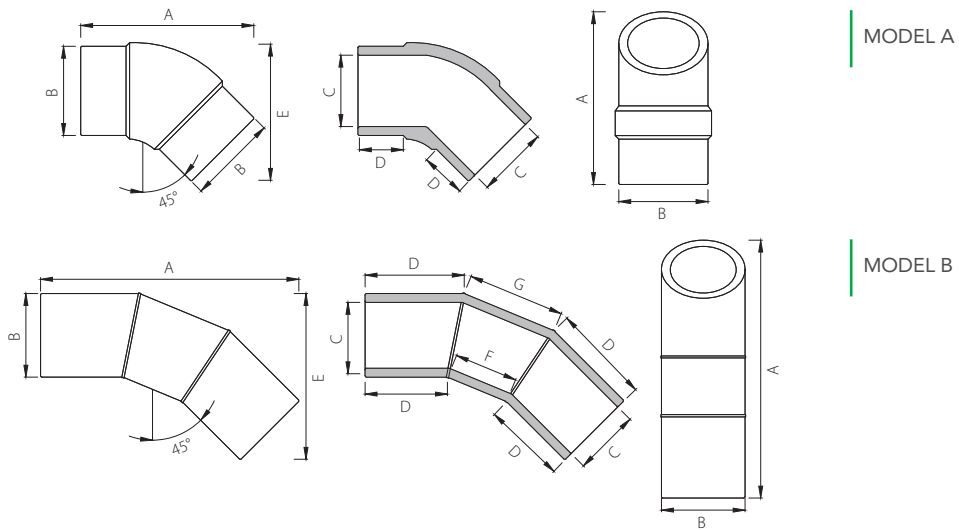

REFERENCE	DIAMETER	A	B min	C	D	E	F	G	WEIGHT	MODEL	BAG	BOX	COLOUR
									(mm)	(kg)	(un)		●
P-2020160 ⁽¹⁾	160	218	160	115,2	120	232	-	-	1,748	A	1	2	✓
CT2020200	200	425	200	163	151	240	-	-	4,100	A	1	1	✓
CT2020250	250	475	250	200	132	275	-	-	7,380	A	1	1	✓
CT2020315	315	550	315	255	152	285	-	-	13,000	A	1	1	✓
CT2020355	355	1100	355	*	349	706	272	413	*	B	1	1	✓
CT2020400	400	1250	400	*	400	800	306	465	*	B	1	1	✓

* Value adjusted according to selected pipe.

⁽¹⁾ Not suitable for electrofusion

ELBOW 90°



CHARACTERISTICS

COLOUR	Green Blue
RAW MATERIAL	PP-R 100 PP-RCT 125
TYPE OF WELDING	Socket
STANDARDS	EN ISO 15874 DIN 16962
COMPATIBLE SYSTEMS	HELISYSTEM ROMAFASER ROMAFASER ANTI-UV ROMAKLIMA ROMAFASER CT ROMAKLIMA CT

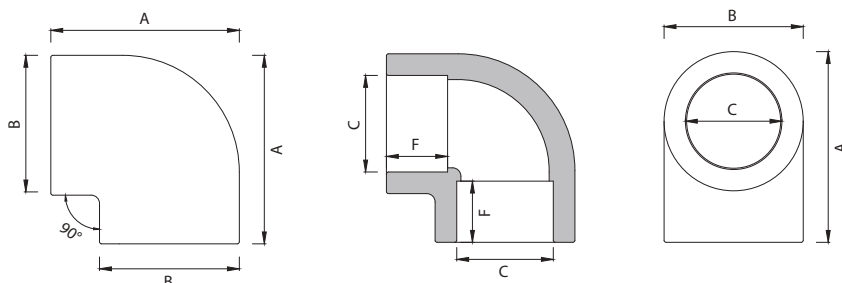

REFERENCE	DIAMETER	A	B	C min	F	WEIGHT	BAG	BOX	COLOUR	
									●	●
		(mm)				(kg)	(un)			
P-CT206020	20	39,1	27,2	19,2	15	0,014	40	320	✓	✓
P-CT206025	25	44,9	32,8	24,2	16	0,023	20	200	✓	✓
P-CT206032	32	57,3	42,6	31,1	18	0,044	10	100	✓	✓
P-206040	40	68,0	53,0	39,0	21	0,075	5	50	✓	✓
P-206050	50	84,0	68,0	48,9	24	0,131	4	32	✓	✓
P-206063	63	104,0	85,0	61,9	28	0,271	2	16	✓	✓
P-206075	75	120,0	100,0	73,7	30	0,432	1	11	✓	✓
P-206090	90	145,0	121,0	88,6	33	0,732	1	6	✓	✓
P-2060110	110	168,0	131,0	108,4	37	1,143	1	4	✓	
P-2060125	125	191,0	155,0	122,4	40	1,734	1	2	✓	

ELBOW 90° XL



CHARACTERISTICS

COLOUR	Green
RAW MATERIAL	PP-R 100 PP-RCT 125
TYPE OF WELDING	Butt Welding Electrofusion
STANDARDS	EN ISO 15874 DIN 16962
COMPATIBLE SYSTEMS	ROMAFASER ROMAKLIMA ROMAFASER CT ROMAKLIMA CT

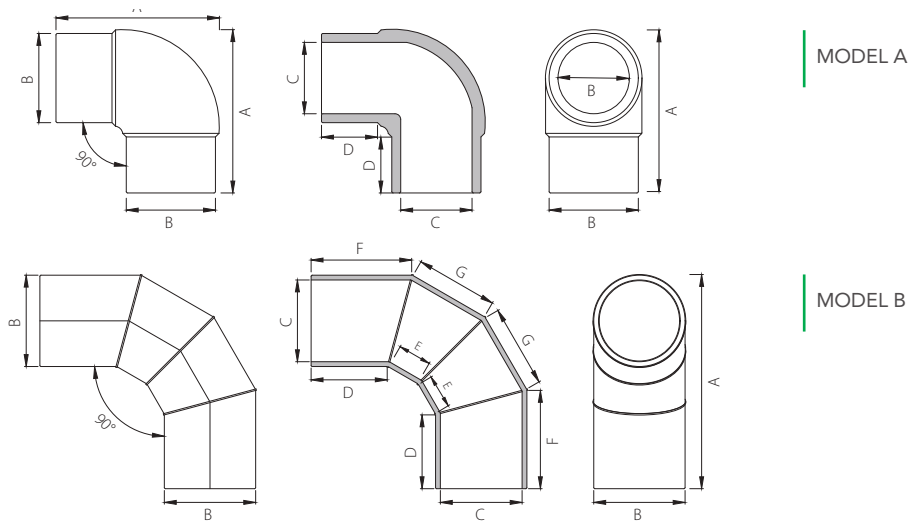

REFERENCE	DIAMETER	A	B min	C	D	E	F	G	WEIGHT	MODEL	BAG	BOX	COLOUR
									(mm)	(kg)	(un)		
P-2060160 ⁽¹⁾	160	223	160	116,2	39	-	-	-	2,567	A	1	2	✓
CT2060200	200	354	200	162,0	151	-	-	-	5,020	A	1	1	✓
CT2060250	250	418	250	202,0	156	-	-	-	9,600	A	1	1	✓
CT2060315	315	522	315	255,0	202	-	-	-	18,900	A	1	1	✓
CT2060315	315	930	315	*	300	241	363	434	*	B	1	1	✓
CT2060355	355	1060	355	*	350	272	421	489	*	B	1	1	✓
CT2060400	400	1200	400	*	400	306	480	551	*	B	1	1	✓

* Value adjusted according to selected pipe.

⁽¹⁾ Not suitable for electrofusion

FEMALE ELBOW



CHARACTERISTICS

COLOUR	Green Blue
RAW MATERIAL	PP-RCT 125 Brass CW617N
TYPE OF WELDING	Socket
STANDARDS	EN ISO 15874 DIN 16962
COMPATIBLE SYSTEMS	HELISYSTEM ROMAFASER ROMAFASER ANTI-UV ROMAKLIMA ROMAFASER CT

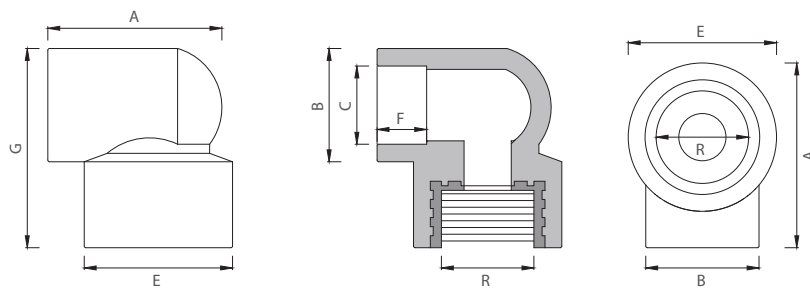

REFERENCE	DIAMETER (mm x in)	A	B	C max	E	F	G	R	WEIGHT (kg)	BAG (un)	BOX	COLOUR	
												●	●
P-CT208020	20x1/2"	45	27	19,5	35	15	45	1/2"	0,045	20	200	✓	✓
P-CT208026	25x1/2"	45	33	24,5	35	16	47	1/2"	0,049	10	100	✓	✓
P-CT208025	25x3/4"	52	33	24,5	41	16	49	3/4"	0,059	10	100	✓	✓
P-CT208033	32x3/4"	57	41	31,5	42	18	60	3/4"	0,076	5	50	✓	✓
P-CT208032	32x1"	60	41	31,5	52	18	63	1"	0,111	5	50	✓	✓

MALE ELBOW



CHARACTERISTICS

COLOUR	Green Blue
RAW MATERIAL	PP-RCT 125 Brass CW617N
TYPE OF WELDING	Socket
STANDARDS	EN ISO 15874 DIN 16962
COMPATIBLE SYSTEMS	HELISYSTEM ROMAFASER ROMAFASER ANTI-UV ROMAKLIMA ROMAFASER CT

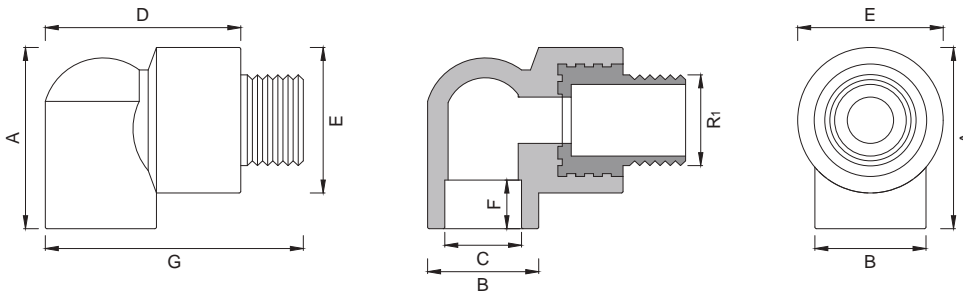

REFERENCE	DIAMETER (mm x in)	A	B	C max	D	E	F	G	R ₁ (in)	WEIGHT (kg)	BAG (un)	BOX	COLOUR	
													✓	✓
P-CT209020	20x1/2"	45	27	19,5	44	35	15	56	1/2"	0,054	20	140	✓	✓
P-CT209026	25x1/2"	45	33	24,5	47	35	16	59	1/2"	0,082	10	100	✓	✓
P-CT209025	25x3/4"	50	33	24,5	52	41	16	67	3/4"	0,046	10	100	✓	✓
P-CT209033	32x3/4"	57	42	31,5	60	42	18	74	3/4"	0,098	5	50	✓	✓
P-CT209032	32x1"	60	43	31,5	63	52	18	78	1"	0,129	5	50	✓	✓

LOOSE NUT ELBOW



CHARACTERISTICS

COLOUR	Green Blue
RAW MATERIAL	PP-RCT 125 Brass CW617N
TYPE OF WELDING	Socket
STANDARDS	EN ISO 15874 DIN 16962
COMPATIBLE SYSTEMS	HELISYSTEM ROMAFASER ROMAFASER ANTI-UV ROMAKLIMA ROMAFASER CT

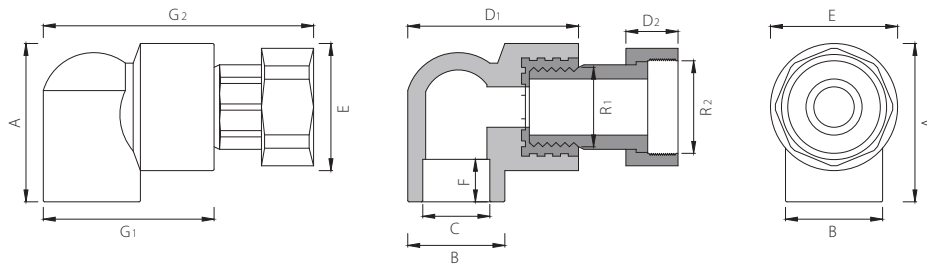

REFERENCE	DIAMETER (mm x in)	A	B	C max	D ₁	D ₂	E	F	G ₁	G ₂	R ₁	R ₂	WEIGHT (kg)	BAG (un)	BOX	COLOUR	
																●	●
P-CT208020-L	20x3/4"	45	27	19,5	45	14	35	15	44	69	1/2"	3/4"	0,108	10	100	✓	✓
P-CT208026-L	25x3/4"	45	33	24,5	47	14	35	16	53	90	1/2"	3/4"	0,112	10	75	✓	✓
P-CT208025-L	25x1"	52	33	24,5	49	16	41	16	51	79	3/4"	1"	0,161	10	75	✓	✓
P-CT208033-L	32x1"	57	41	31,5	63	16	42	18	66	98	3/4"	1"	0,178	5	50	✓	✓
P-CT208032-L	32x1 1/4"	60	41	31,5	60	19	52	18	66	95	1"	1 1/4"	0,276	5	50	✓	✓

WALL PLATE FEMALE ELBOW



CHARACTERISTICS

COLOUR	Green Blue
RAW MATERIAL	PP-R 100 Brass CW617N
TYPE OF WELDING	Socket
STANDARDS	EN ISO 15874 DIN 16962
COMPATIBLE SYSTEMS	HELISYSTEM ROMAFASER ROMAFASER ANTI-UV ROMAKLIMA ROMAFASER CT

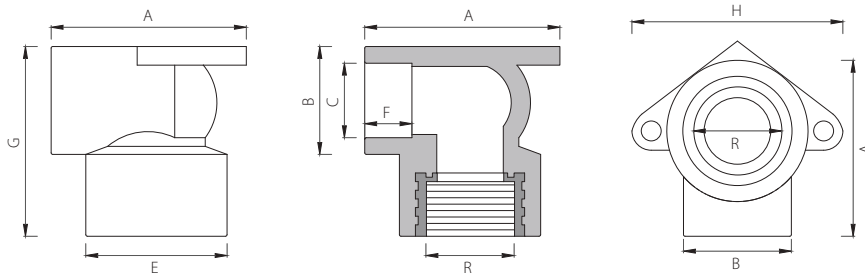

REFERENCE	DIAMETER	A	B	C max	E	F	G	H	R	WEIGHT	BAG	BOX	COLOUR
	(mm x in)	(mm)							(in)	(kg)	(un)		<input type="checkbox"/> <input type="checkbox"/>
P-212020	20x1/2"	57	30	19,5	39	15	50	60	1/2"	0,060	10	100	✓ ✓
P-212026	25x1/2"	52	35	24,5	45	16	55	66	1/2"	0,074	10	100	✓ ✓
P-212025	25x3/4"	58	35	24,5	45	16	55	65	3/4"	0,074	10	100	✓ ✓

TEE



CHARACTERISTICS

COLOUR	Green Blue
RAW MATERIAL	PP-R 100 PP-RCT 125
TYPE OF WELDING	Socket
STANDARDS	EN ISO 15874 DIN 16962
COMPATIBLE SYSTEMS	HELISYSTEM ROMAFASER ROMAFASER ANTI-UV ROMAKLIMA ROMAFASER CT ROMAKLIMA CT

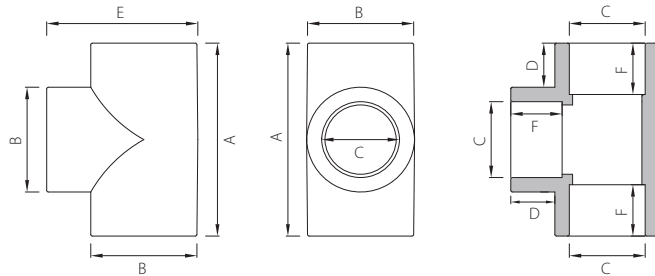

REFERENCE	DIAMETER	A	B	C min	D	E	F	WEIGHT	BAG	BOX	COLOUR	
											Green	Blue
				(mm)				(kg)	(un)			
P-CT230020	20	51	27	19,2	12	39	15	0,018	25	250	✓	✓
P-CT230025	25	60	33	24,2	14	46	16	0,028	15	150	✓	✓
P-CT230032	32	73	43	31,1	16	43	18	0,056	10	80	✓	✓
P-230040	40	83	53	39,0	18	76	21	0,100	5	50	✓	✓
P-230050	50	100	66	48,9	19	98	24	0,178	2	30	✓	✓
P-230063	63	124	85	61,9	19	103	28	0,351	2	12	✓	✓
P-230075	75	141	101	73,7	21	129	31	0,558	1	9	✓	✓
P-230090	90	165	120	88,6	23	145	37	0,882	1	6	✓	✓
P-2300110	110	201	140	108,4	28	169	42	1,534	1	4	✓	
P-2300125	125	223	163	122,4	30	180	40	2,202	1	2	✓	

TEE XL



CHARACTERISTICS

COLOUR	Green
RAW MATERIAL	PP-R 100 PP-RCT 125
TYPE OF WELDING	Butt welding Electrofusion
STANDARDS	EN ISO 15874 DIN 16962
COMPATIBLE SYSTEMS	ROMAFASER ROMAKLIMA ROMAFASER CT ROMAKLIMA CT

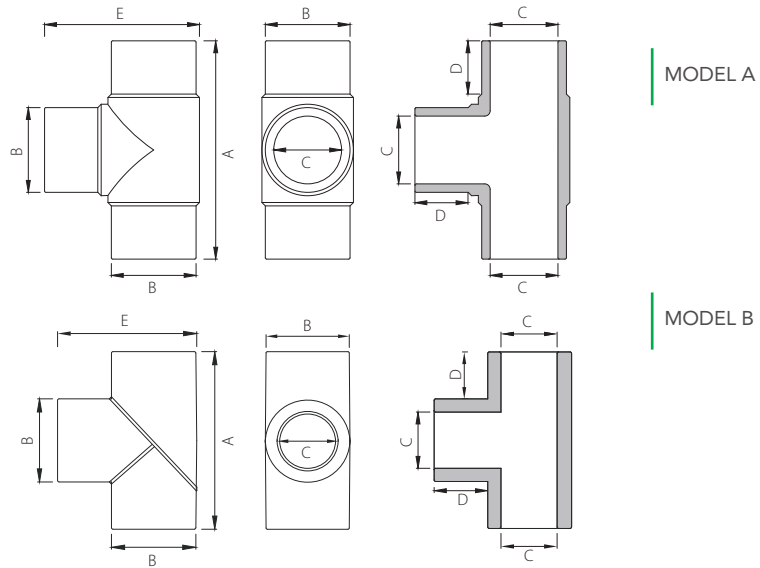

REFERENCE	DIAMETER	A	B min	C	D	E	WEIGHT	MODEL	BAG	BOX	COLOUR
			(mm)				(kg)		(un)		
P-2300160 ⁽¹⁾	160	296	160	116,8	39	235	3,287	A	1	1	✓
CT2300200	200	500	200	159,7	120	348	7,546	A	1	1	✓
CT2300250	250	573	250	214	131	410	12,480	A	1	1	✓
CT2300315	315	945	315	277	295	624	20,700	B	1	1	✓
CT2300355	355	948	355	307	309	656	25,800	B	1	1	✓
CT2300400	400	1145	400	349	324	740	36,520	B	1	1	✓

⁽¹⁾ Not suitable for electrofusion

REDUCED TEE



CHARACTERISTICS

COLOUR	Green Blue
RAW MATERIAL	PP-R 100 PP-RCT 125
TYPE OF WELDING	Socket
STANDARDS	EN ISO 15874 DIN 16962
COMPATIBLE SYSTEMS	HELISYSTEM ROMAFASER ROMAFASER ANTI-UV ROMAKLIMA ROMAFASER CT ROMAKLIMA CT

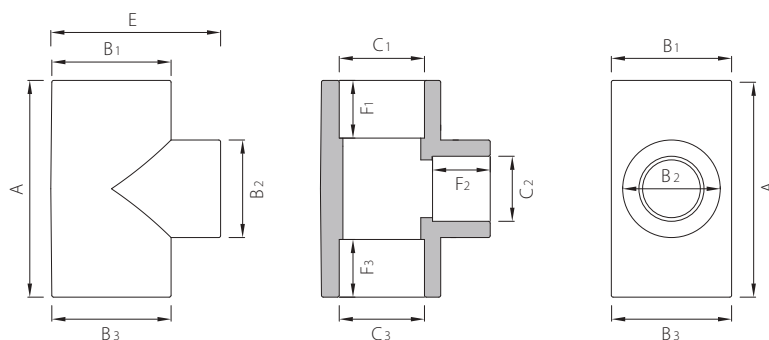



REFERENCE	DIAMETER	A	B ₁	B ₂	B ₃	C ₁	C ₂	C ₃	F ₁	F ₂	F ₃	E	WEIGHT	BAG	BOX	COLOUR	
(mm)																	
P-CT231020	25x20x20	53	33	24	14	27	19	12	16	15	15	44	0,022	20	140	✓	✓
P-CT231025	25x20x25	54	33	24	14	27	19	12	16	16	15	45	0,025	20	140	✓	✓
P-CT231023	25x25x20	56	33	24	13	33	24	14	16	15	16	46	0,024	20	140	✓	✓
P-231032	32x20x32	60	43	31	15	29	19	11	18	15	18	55	0,046	10	80	✓	✓
P-231035	32x25x25	64	42	31	15	35	24	12	18	16	18	54	0,045	10	80	✓	✓
P-CT231033	32x25x32	64	42	31	15	34	24	12	18	16	16	54	0,047	10	80	✓	✓
P-231041	40x20x40	61	54	39	16	29	19	10	21	15	21	64	0,063	5	50	✓	✓
P-231042	40x25x40	65	54	39	15	34	24	10	21	16	21	64	0,070	5	50	✓	✓
P-231043	40x32x40	77	54	39	17	43	31	13	21	18	21	67	0,086	5	50	✓	✓
P-231052	50x25x50	70	67	49	18	34	24	10	24	16	24	76	0,109	4	32	✓	✓
P-231053	50x32x50	80	67	49	19	42	31	11	24	18	24	76	0,127	4	32	✓	✓

CONTINUED >



CONTINUED >

REFERENCE	DIAMETER	A	B ₁	B ₂	B ₃	C ₁	C ₂	C ₃	F ₁	F ₂	F ₃	E	WEIGHT	BAG	BOX	COLOUR	
													(kg)	(un)			
		(mm)											(kg)	(un)			
P-231054	50x40x50	91	67	49	19	54	39	14	24	21	24	81	0,147	4	32	✓	✓
P-231062	63x25x63	83	85	62	24	34	24	10	28	16	28	94	0,194	2	12	✓	✓
P-231063	63x32x63	92	85	62	25	43	31	10	28	18	28	94	0,220	2	12	✓	✓
P-231064	63x40x63	98	84	62	21	54	39	10	28	21	28	94	0,235	2	12	✓	✓
P-231065	63x50x63	111	85	62	23	67	49	15	28	24	28	111	0,291	2	12	✓	✓
P-231074	75x40x75	107	101	74	27	54	39	10	31	21	31	109	0,365	1	8	✓	✓
P-231075	75x50x75	117	101	74	25	67	49	12	31	24	31	111	0,403	1	8	✓	✓
P-231076	75x63x75	131	101	74	23	86	62	17	31	28	31	117	0,481	1	8	✓	✓
P-231097	90x75x90	155	120	89	27	102	74	18	37	31	37	138	0,763	1	4	✓	✓
P-2310110	110x90x110	182	144	108	31	121	89	23	42	37	42	166	1,218	1	2	✓	
P-2310125	125x110x125	222	163	122	30	162	108	30	40	42	40	193	2,317	1	1	✓	

FEMALE TEE



CHARACTERISTICS

COLOUR	Green Blue
RAW MATERIAL	PP-RCT 125 Brass CW617N
TYPE OF WELDING	Socket
STANDARDS	EN ISO 15874 DIN 16962
COMPATIBLE SYSTEMS	HELISYSTEM ROMAFASER ROMAFASER ANTI-UV ROMAKLIMA ROMAFASER CT

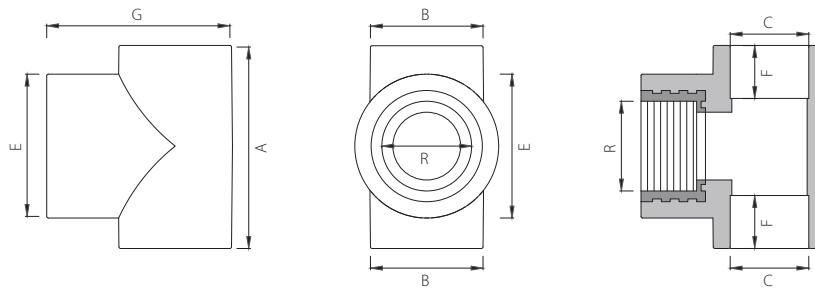

REFERENCE	DIAMETER (mm x in)	A	B	C max	E	F	G	R	WEIGHT (kg)	BAG (un)	BOX	COLOUR	
												●	●
P-CT232020	20x1/2"	55	27	19,5	34	15	44	1/2"	0,049	20	160	✓	✓
P-CT232026	25x1/2"	57	33	24,5	35	16	47	1/2"	0,053	10	100	✓	✓
P-CT232025	25x3/4"	58	33	24,5	41	16	52	3/4"	0,065	10	100	✓	✓
P-CT232033	32x3/4"	69	42	31,5	42	18	60	3/4"	0,082	5	50	✓	✓
P-CT232032	32x1"	69	44	31,5	52	18	63	1"	0,112	5	50	✓	✓

MALE TEE



CHARACTERISTICS

COLOUR	Green Blue
RAW MATERIAL	PP-RCT 125 Brass CW617N
TYPE OF WELDING	Socket
STANDARDS	EN ISO 15874 DIN 16962
COMPATIBLE SYSTEMS	HELISYSTEM ROMAFASER ROMAFASER ANTI-UV ROMAKLIMA ROMAFASER CT

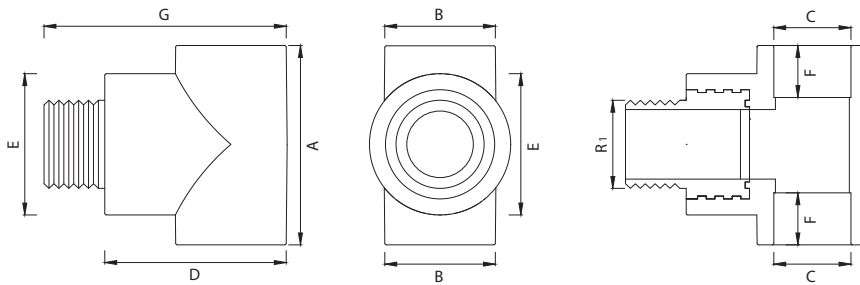

REFERENCE	DIAMETER (mm x in)	A	B	C max	D			E	F	G	R ₁ (in)	WEIGHT (kg)	BAG (un)	BOX	COLOUR	
					(mm)	(mm)	(mm)								Green	Blue
P-CT233020	20x1/2"	55	27	19,5	44	35	15	56	1/2"	0,058	10	100	✓	✓		
P-CT233026	25x1/2"	57	33	24,5	47	35	16	59	1/2"	0,063	10	100	✓	✓		
P-CT233025	25x3/4"	58	33	24,5	52	42	16	67	3/4"	0,086	10	100	✓	✓		
P-CT233033	32x3/4"	69	42	31,5	60	42	16	59	3/4"	0,104	10	100	✓	✓		
P-CT233032	32x1"	69	44	31,5	63	52	18	77	1"	0,132	5	50	✓	✓		

UNION



CHARACTERISTICS

COLOUR	Green Blue
RAW MATERIAL	PP-R 100 PP-RCT 125
TYPE OF WELDING	Socket
STANDARDS	EN ISO 15874 DIN 16962
COMPATIBLE SYSTEMS	HELISYSTEM ROMAFASER ROMAFASER ANTI-UV ROMAKLIMA ROMAFASER CT ROMAKLIMA CT

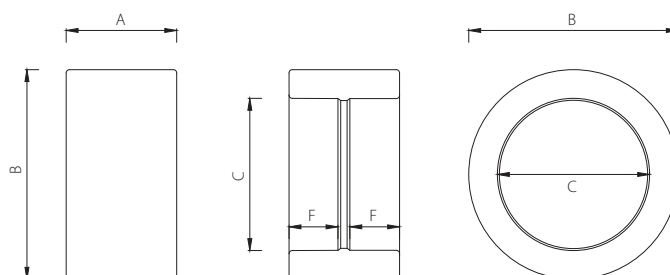

REFERENCE	DIAMETER	A	B	C min	F	WEIGHT	BAG	BOX	COLOUR	
									Green	Blue
						(kg)		(un)		
P-CT200020	20	31	27	19,2	15	0,090	50	500	✓	✓
P-CT200025	25	34	33	24,2	16	0,014	40	320	✓	✓
P-CT200032	32	39	42	31,1	18	0,025	20	200	✓	✓
P-200040	40	43	54	39,0	21	0,046	10	100	✓	✓
P-200050	50	49	66	48,9	24	0,077	5	60	✓	✓
P-200063	63	58	85	61,9	28	0,142	4	32	✓	✓
P-200075	75	65	101	73,7	31	0,223	2	24	✓	✓
P-200090	90	75	120	88,6	37	0,350	1	13	✓	✓
P-2000110	110	88	144	108,4	42	0,561	1	10	✓	✓
P-2000125	125	90	162	122,4	40	0,702	1	6	✓	

REDUCER UNION



CHARACTERISTICS

COLOUR	Green Blue
RAW MATERIAL	PP-R 100 PP-RCT 125
TYPE OF WELDING	≤ 125 - welding male/female
	> 125 - butt welding
STANDARDS	EN ISO 15874 DIN 16962
COMPATIBLE SYSTEMS	HELISYSTEM ROMAFASER ROMAFASER ANTI-UV ROMAKLIMA ROMAFASER CT ROMAKLIMA CT

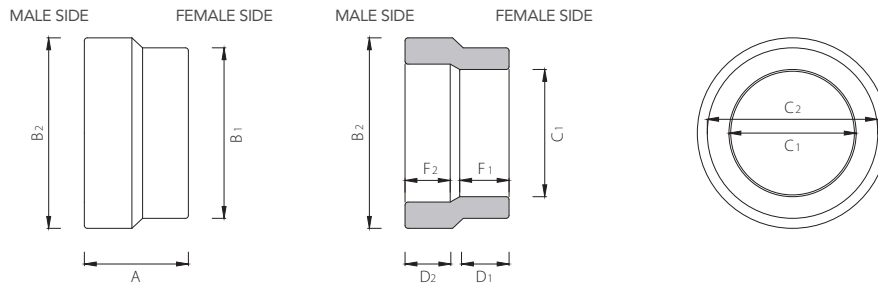

REFERENCE	DIAMETER	A	MALE SIDE				FEMALE SIDE				WEIGHT (kg)	BAG (un)	BOX (un)	COLOUR	
			B ₂	C ₂	D ₂	F ₂	B ₁	C ₁	D ₁	F ₁				●	●
(mm)											(kg)	(un)			
P-CT238025	25x20	34	25	17	16	19	27	19	16	15	0,011	50	100	✓	✓
P-CT238032	32x20	37	32	24	19	16	28	19	17	15	0,016	30	100	✓	✓
P-CT238033	32x25	34	32	24	21	18	32	24	13	16	0,014	30	100	✓	✓
P-238040	40x20	41	40	27	22	23	29	19	15	15	0,030	20	100	✓	✓
P-238041	40x25	43	40	29	20	20	34	24	17	16	0,028	20	100	✓	✓
P-238042	40x32	47	40	29	29	21	42	31	18	18	0,035	20	100	✓	✓
P-238051	50x20	45	50	37	23	18	28	19	15	15	0,035	10	100	✓	✓
P-238055	50x25	47	50	37	23	19	34	24	16	16	0,036	10	100	✓	✓
P-238052	50x32	54	51	36	24	26	42	32	20	18	0,051	10	100	✓	✓
P-238050	50x40	52	51	37	31	24	52	39	20	21	0,053	10	100	✓	✓

CONTINUED >



CONTINUED >

REFERENCE	DIAMETER	A	MALE SIDE				FEMALE SIDE				WEIGHT (kg)	BAG (un)	BOX	COLOUR		
			B ₂	C ₂	D ₂	F ₂	B ₁	C ₁	D ₁	F ₁				●	●	
													(mm)			
P-238062	63x25	53	64	44	22	23	34	24	19	16	0,058	5	100	✓	✓	
P-238065	63x32	50	64	47	27	21	42	31	18	18	0,058	5	100	✓	✓	
P-238063	63x40	48	64	47	25	20	53	39	18	21	0,059	5	100	✓	✓	
P-238067	63x50	53	64	43	29	28	66	49	24	24	0,089	5	100	✓	✓	
P-238075	75x50	60	76	55	31	24	66	49	24	24	0,107	4	100	✓	✓	
P-238076	75x63	70	76	50	34	32	84	62	28	28	0,172	4	100	✓	✓	
P-238096	90x63	66	91	65	35	27	83	62	28	28	0,171	2	100	✓	✓	
P-238097	90x75	80	91	64	37	34	99	73	30	31	0,251	2	100	✓	✓	
P-2380116	110x63	72	110	80	42	28	83	62	27	28	0,271	1	100	✓	✓	
P-2380117	110x75	77	110	80	42	30	98	74	31	31	0,284	1	100	✓	✓	
P-2380110	110x90	93	110	75	44	38	118	88	35	33	0,417	1	100	✓	✓	
P-2380125	125x110	114	125	85	62	72	141	109	47	37	0,745	1	100	✓		
P-2380160	160x110	87	161	116	41	40	145	108	39	37	0,679	1	100	✓		
P-2380161	160x125	88	161	123	44	42	160	123	44	40	0,710	1	100	✓		

REDUCER UNION XL



CHARACTERISTICS

COLOUR	Green
RAW MATERIAL	PP-R 100 PP-RCT 125
TYPE OF WELDING	Butt Welding Electrofusion
STANDARDS	EN ISO 15874 DIN 16962
COMPATIBLE SYSTEMS	ROMAFASER ROMAKLIMA ROMAFASER CT ROMAKLIMA CT

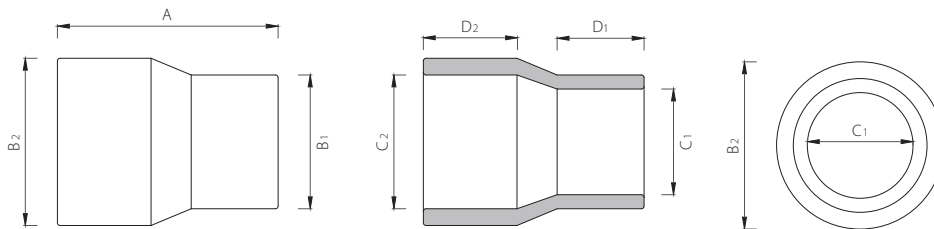

REFERENCE	DIAMETER	A	B ₁	B ₂	C ₁	C ₂	D ₁	D ₂	WEIGHT	BAG	BOX	COLOUR
									(kg)	(un)		●
(mm)												
P-2380160 ⁽¹⁾	160x110	82	138	160	108,4	116	39,9	39,9	0,679	1	8	✓
P-2380161 ⁽¹⁾	160x125	88	150,9	160	123,5	123,7	41	41,7	0,710	1	6	✓
CT2380200	200x160	280	160	200	130	162	120	126	2,280	1	1	✓
CT2380250	250x160	310	160	250	130	203	100	152	3,920	1	1	✓
CT2380251	250x200	320	200	250	160	201	115	150	4,520	1	1	✓
CT2380315	315x200	376	200	315	157	256	129	142	7,200	1	1	✓
CT2380316	315x250	344	250	315	200	256	118	142	7,220	1	1	✓

⁽¹⁾ Not suitable for electrofusion

FEMALE UNION



CHARACTERISTICS

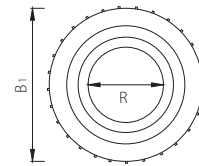
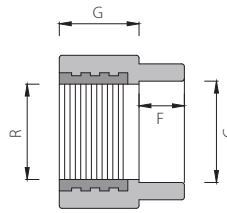
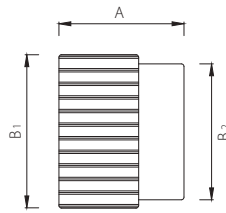

COLOUR	Green Blue
RAW MATERIAL	PP-R 100 PP-RCT 125 Brass CW617N
TYPE OF WELDING	Socket
STANDARDS	EN ISO 15874 DIN 16962
COMPATIBLE SYSTEMS	HELISYSTEM ROMAFASER ROMAFASER ANTI-UV ROMAKLIMA ROMAFASER CT

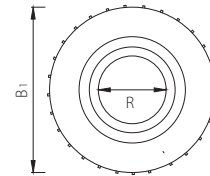
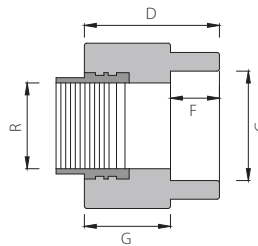
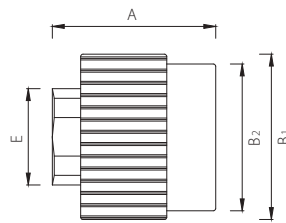

MODEL A



MODEL B

REFERENCE	DIAMETER	A	B ₁	B ₂	C min	D	E	F	G	R	WEIGHT	MODEL	BAG	BOX	COLOUR
	(mm x in)	(mm)					(in)					(kg)		(un)	 
P-CT234020	20x1/2"	35	33	27	19,2	-	-	15	21	1/2"	0,038	A	20	200	✓ ✓
P-CT234026	25x1/2"	35	36	33	24,2	-	-	16	21	1/2"	0,041	A	10	150	✓ ✓
P-CT234025	25x3/4"	39	40	33	24,2	-	-	16	21	3/4"	0,049	A	10	150	✓ ✓
P-CT234033	32x3/4"	41	42	43	31,1	-	-	19	26	3/4"	0,054	A	10	100	✓ ✓
P-CT234032	32x1"	47	53	43	31,1	-	-	19	26	1"	0,088	A	10	100	✓ ✓
P-234040	40x1 1/4"	57	68	54	39,0	48	48	21	28	1 1/4"	0,251	B	5	50	✓ ✓
P-234050	50x1 1/2"	62	80	66	48,9	53	54	24	32	1 1/2"	0,378	B	4	36	✓ ✓
P-234063	63x2"	76	94	84	61,9	60	65	28	32	2"	0,569	B	2	20	✓ ✓
P-234075	75x2 1/2"	85	114	100	73,7	63	81	31	32	2 1/2"	0,945	B	1	15	✓ ✓
P-234090	90x3"	92	128	119	88,6	71	94	33	34	3"	1,241	B	1	16	✓ ✓
P-2340110	110x4"	104	164	144	108,4	83	119	37	41	4"	2,011	B	1	6	✓ ✓

MALE UNION



CHARACTERISTICS

COLOUR	Green Blue
RAW MATERIAL	PP-R 100 PP-RCT 125 Brass CW617N
TYPE OF WELDING	Socket
STANDARDS	EN ISO 15874 DIN 16962
COMPATIBLE SYSTEMS	HELISYSTEM ROMAFASER ROMAFASER ANTI-UV ROMAKLIMA ROMAFASER CT

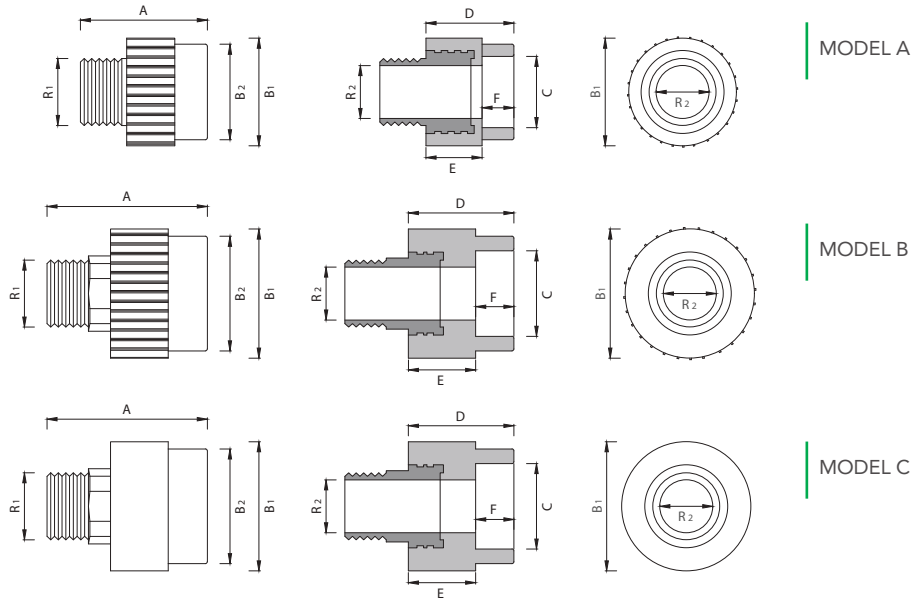

REFERENCE	DIAMETER	A	B ₁	B ₂	C min	D	E	F	R ₁	R ₂	WEIGHT	MODEL	BAG	BOX	COLOUR
	(mm x in)				(mm)				(in)	(mm)	(kg)			(un)	<input checked="" type="checkbox"/> <input type="checkbox"/>
P-CT325020	20x1/2"	47	33	27	19,2	33	15	21	1/2"	16	0,047	A	20	200	✓ ✓
P-CT325026	25x1/2"	48	36	33	24,2	34	16	21	1/2"	16	0,051	A	10	150	✓ ✓
P-CT325025	25x3/4"	53	40	33	24,2	36	16	21	3/4"	20	0,071	A	10	150	✓ ✓
P-CT325033	32x3/4"	55	42	43	31,1	39	18	26	3/4"	20	0,076	A	10	100	✓ ✓
P-CT325032	32x1"	61	51	43	31,1	41	18	26	1"	26	0,108	A	10	100	✓ ✓
P-325040	40x1 1/4"	77	68	54	39,0	48	21	28	1 1/4"	35	0,296	B	4	40	✓ ✓
P-325050	50x1 1/2"	90	79	66	48,9	54	24	32	1 1/2"	40	0,537	B	4	32	✓ ✓
P-325063	63x2"	98	95	84	61,9	60	28	32	2"	52	0,797	C	2	16	✓ ✓
P-325075	75x2 1/2"	109	112	100	73,7	64	31	32	2 1/2"	66	1,208	C	1	12	✓ ✓
P-325090	90x3"	121	127	119	88,6	67	37	34	3"	78	1,65	C	1	8	✓ ✓
P-3250110	110x4"	137	166	144	108,4	78	42	41	4"	103	2,529	C	1	3	✓ ✓

LOOSE NUT UNION



CHARACTERISTICS

COLOUR	Green Blue
RAW MATERIAL	PP-R 100 PP-RCT 125 Brass CW617N
TYPE OF WELDING	Socket
STANDARDS	EN ISO 15874 DIN 16962
COMPATIBLE SYSTEMS	HELISYSTEM ROMAFASER ROMAFASER ANTI-UV ROMAKLIMA ROMAFASER CT

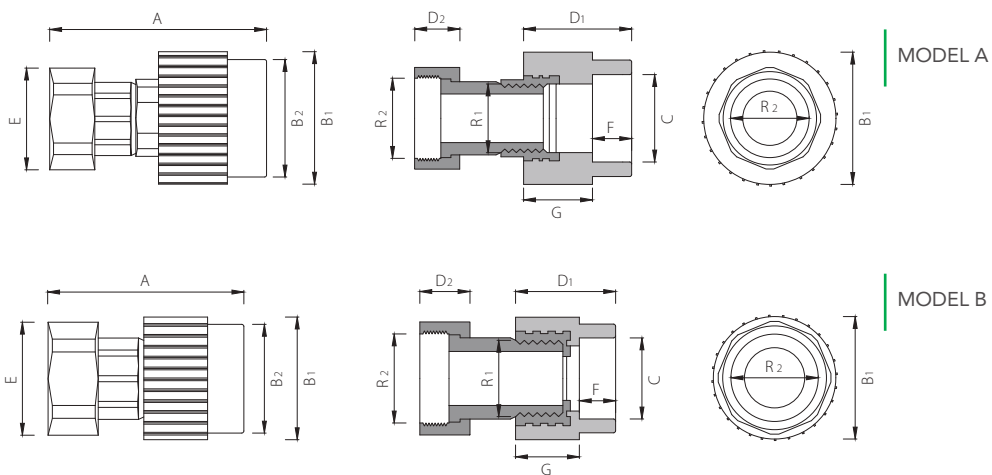

REFERENCE	DIAMETER	A	B ₁	B ₂	C min	D ₁	D ₂	E	F	G	R ₁	R ₂	WEIGHT	MODEL	BAG	BOX	COLOUR	
																	●	●
	(mm x in)				(mm)						(in)		(kg)		(un)			
P-CT234020-L	20x3/4"	67	33	27	19,2	35	13	32	15	21	1/2"	3/4"	0,113	A	10	100	✓	✓
P-CT234026-L	25x3/4"	67	36	33	24,2	35	13	32	16	21	1/2"	3/4"	0,115	A	10	100	✓	✓
P-CT234025-L	25x1"	72	40	33	24,2	39	16	41	16	21	3/4"	1"	0,211	A	10	100	✓	✓
P-CT234033-L	32x1"	81	53	43	31,1	47	16	51	19	26	3/4"	1"	0,210	A	5	60	✓	✓
P-CT234032-L	32x1 1/4"	81	42	43	31,1	41	17	51	19	26	1"	1 1/4"	0,389	A	5	60	✓	✓
P-234040-L	40X1 1/2"	94	68	54	39	57	18	58	21	28	1 1/4"	1 1/2"	0,253	B	3	30	✓	✓
P-234050-L	50x2"	107	80	66	48,9	62	22	71	24	32	1 1/2"	2"	1,013	B	2	24	✓	✓
P-234063-L	63x2 1/2"	123	94	84	61,9	76	26	89	28	32	2"	2 1/2"	1,241	B	1	12	✓	✓
P-234075-L	75x3"	135	114	100	73,7	85	28	101	31	32	2 1/2"	3"	2,456	B	1	9	✓	✓

BRASS FEMALE UNION



CHARACTERISTICS

COLOUR	Green Blue
RAW MATERIAL	PP-R 100 Brass CW617N
TYPE OF WELDING	Socket
STANDARDS	EN ISO 15874 DIN 16962
COMPATIBLE SYSTEMS	HELISYSTEM ROMAFASER ROMAFASER ANTI-UV ROMAKLIMA ROMAFASER CT

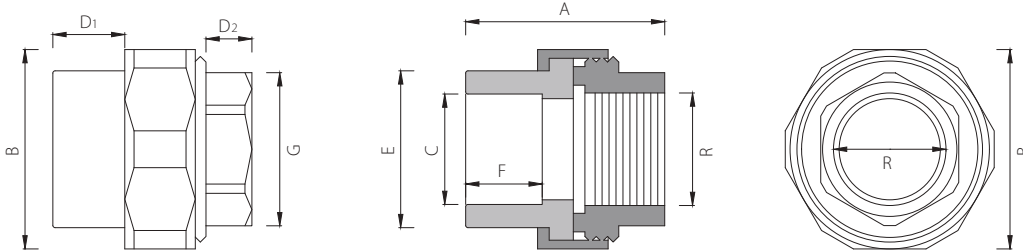

REFERENCE	DIAMETER	A	B	C max	D ₁	D ₂	E	F	G	R	WEIGHT	BAG	BOX	COLOUR	
	(mm x in)													(mm)	(in)
P-200020-DH	20x1/2"	39	39	19,5	15	10	28	15	24	1/2"	0,095	10	80	✓	✓
P-200025-DH	25x3/4"	41	50	24,5	16	10	33	16	30	3/4"	0,119	10	60	✓	✓
P-200032-DH	32x1"	45	65	31,5	18	11	43	18	37	1"	0,194	5	30	✓	✓
P-200040-DH	40x1 1/4"	50	63	39,4	21	12	51	21	34	1 1/4"	0,229	2	16	✓	✓
P-200050-DH	50x1 1/2"	57	80	49,4	25	12	66	24	52	1 1/2"	0,975	2	12	✓	✓

BRASS MALE UNION



CHARACTERISTICS

COLOUR	Green Blue
RAW MATERIAL	PP-R 100 Brass CW617N
TYPE OF WELDING	Socket
STANDARDS	EN ISO 15874 DIN 16962
COMPATIBLE SYSTEMS	HELISYSTEM ROMAFASER ROMAFASER ANTI-UV ROMAKLIMA ROMAFASER CT

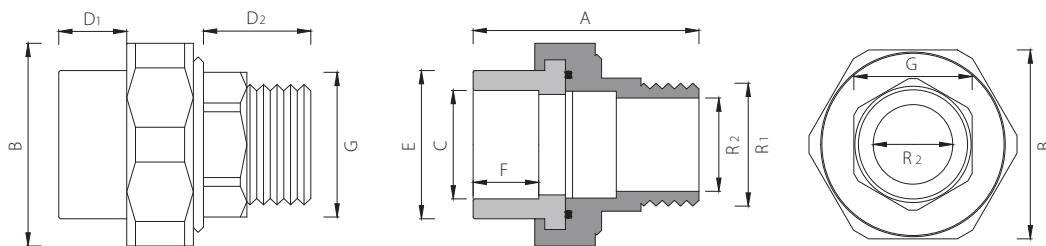

REFERENCE	DIAMETER (mm x in)	A	B	C max	D ₁	D ₂	E	F	G	R	WEIGHT (kg)	BAG (un)	BOX (un)	COLOUR	
														Green	Blue
P-200020-DM	20x1/2"	50	39	19,5	15	21	28	15	22	1/2"	0,103	10	80	✓	✓
P-200025-DM	25x3/4"	51	45	24,5	16	21	33	16	37	3/4"	0,133	10	60	✓	✓
P-200032-DM	32x1"	58	55	31,5	18	23	43	18	34	1"	0,210	5	30	✓	✓
P-200040-DM	40x1 1/4"	62	63	39,4	20	23	51	21	42	1 1/4"	0,260	2	16	✓	✓
P-200050-DM	50x1 1/2"	71	80	49,4	24	25	66	24	31	1 1/2"	0,463	2	12	✓	✓

UNIVERSAL UNION



CHARACTERISTICS

COLOUR	Green Blue
RAW MATERIAL	PP-R 100 Brass CW617N
TYPE OF WELDING	Socket
STANDARDS	EN ISO 15874 DIN 16962
COMPATIBLE SYSTEMS	HELISYSTEM ROMAFASER ROMAFASER ANTI-UV ROMAKLIMA ROMAFASER CT

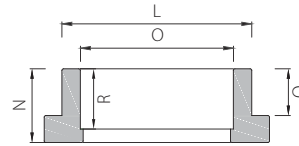
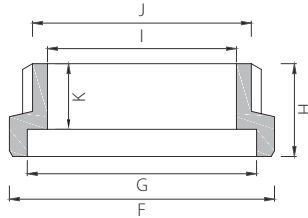
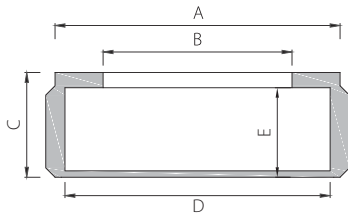

REFERENCE	DN	A	B	C	D	E	F	G	H	I	J	K	L	N	O _{min}	Q	R	WG	BAG	BOX	COLOUR			
																			(mm)		(kg)	(un)	●	●
P-200020-D	20	43,0	28,5	15,8	15	13,8	11	2,0	13,5	2,3	M40x1,5	34,6	28	21,5	19,2	16,6	14,6	0,113	10	100	✓	✓		
P-200025-D	25	49,5	33,7	15,9	16	13,9	10,6	2,0	13,5	2,4	M46x1,5	39,8	33	23,2	24,2	18	16,1	0,145	10	70	✓	✓		
P-200032-D	32	61,0	43,6	17	19	15	12	2,0	14,4	2,6	M57x2,0	50,4	43	25,9	31,1	21,2	18,5	0,234	5	35	✓	✓		
P-200040-D	40	67,5	51,2	20,3	21	17,8	13,8	2,5	17,3	3,0	M63x2,0	56,5	51	29,5	39,0	22,9	20,5	0,307	2	24	✓	✓		
P-200050-D	50	84,0	66,6	24,5	24	22	16,7	2,5	21,5	3,0	M80x2,0	73	66	35,5	48,9	27	23,8	0,519	2	12	✓	✓		
200063-D	63	97,8	78,8	25,1	28	21,9	-	84,9	21	78,9	84,7	13,5	72	39,1	61,9	30,4	23,4	0,685	2	10	✓			

WELD-IN SADDLE



CHARACTERISTICS

COLOUR	Green
RAW MATERIAL	PP-R 100
TYPE OF WELDING	Socket
STANDARDS	EN ISO 15874 DIN 16962
COMPATIBLE SYSTEMS	HELISYSTEM ROMAFASER ROMAFASER ANTI-UV ROMAKLIMA ROMAFASER CT ROMAKLIMA CT

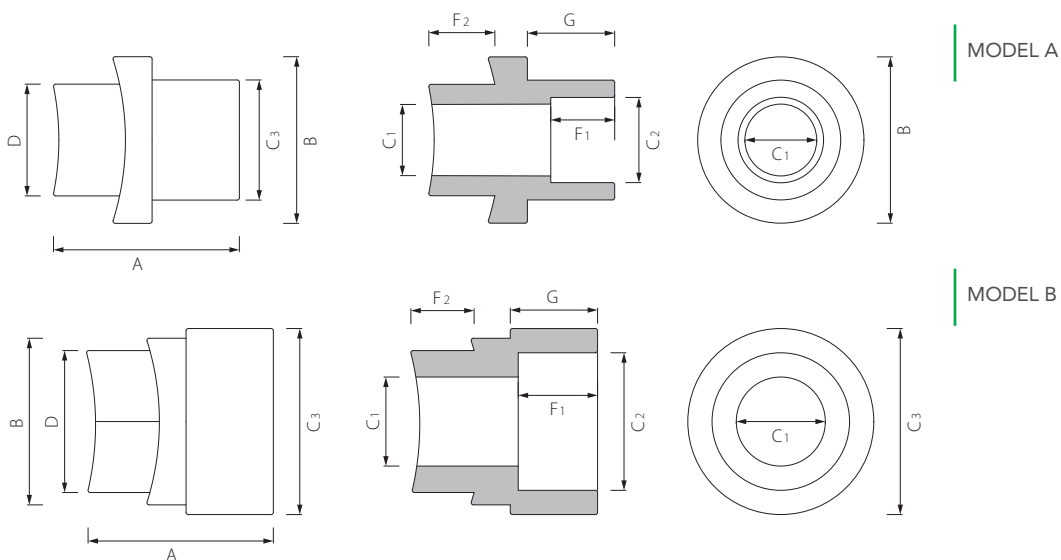

REFERENCE	DIAMETER	A	B	C ₁	C ₂ min	C ₃	D	F ₁	F ₂	G	WEIGHT	MODEL	BAG	BOX	COLOUR
	(mm)					(mm)					(kg)			(un)	●
P-480063	63-75-90x20	38	38	16	19,2	27	25	15	10	22	0,018	A	50	400	✓
P-480064	63-75-90x25	38	38	16	24,2	33	25	16	10	22	0,019	A	40	320	✓
P-480065	63-75-90x32	46	38	20	31,1	42	32	18	11	28	0,032	B	20	200	✓
P-480110	110-125-160x20	42	38	16	19,2	27	25	15	14	22	0,019	A	50	400	✓
P-480111	110-125-160x25	42	38	16	24,2	33	25	16	14	22	0,020	B	40	320	✓
P-480112	110-125-160x32	50	38	20	31,1	42	32	18	14	28	0,033	B	20	200	✓

Note: the necessary tools for the fusion of HELIROMA weld-in saddles are listed on pages 140 and 141.

WELD-IN SADDLE FEMALE



CHARACTERISTICS

COLOUR	Green
RAW MATERIAL	PP-R 100 Brass CW617N
TYPE OF WELDING	Socket
STANDARDS	EN ISO 15874 DIN 16962
COMPATIBLE SYSTEMS	HELISYSTEM ROMAFASER ROMAFASER ANTI-UV ROMAKLIMA ROMAFASER CT ROMAKLIMA CT

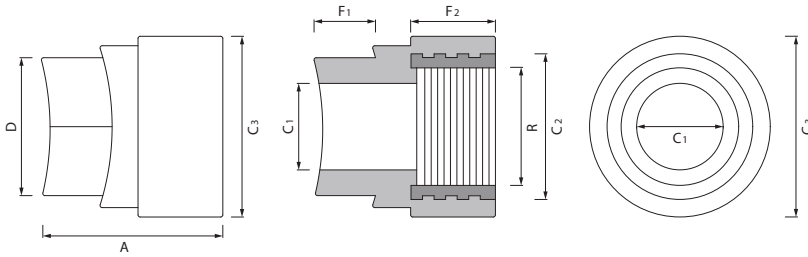

REFERENCE	DIAMETER	A	B	C ₁	C ₂	C ₃	D	F ₁	F ₂	R	WEIGHT	BAG	BOX	COLOUR
	(mm x in)	(mm)						(in)	(kg)	(un)				
P-490063	63-75-90x1/2"	46	38	20	27	42	32	10	28	1/2"	0,060	20	200	✓
P-490064	63-75-90x3/4"	46	38	20	32	42	32	10	28	3/4"	0,061	20	200	✓
P-490110	110-125-160x1/2"	50	38	20	27	42	32	15	28	1/2"	0,063	20	200	✓
P-490111	110-125-160x3/4"	50	38	20	32	42	32	15	28	3/4"	0,062	20	200	✓

Note: the necessary tools for the fusion of HELIROMA weld-in saddles are listed on pages 142 and 143.

WELD-IN SADDLE MALE



CHARACTERISTICS

COLOUR	Green
RAW MATERIAL	PP-R 100 Brass CW617N
TYPE OF WELDING	Socket
STANDARDS	EN ISO 15874 DIN 16962
COMPATIBLE SYSTEMS	HELISYSTEM ROMAFASER ROMAFASER ANTI-UV ROMAKLIMA ROMAFASER CT ROMAKLIMA CT

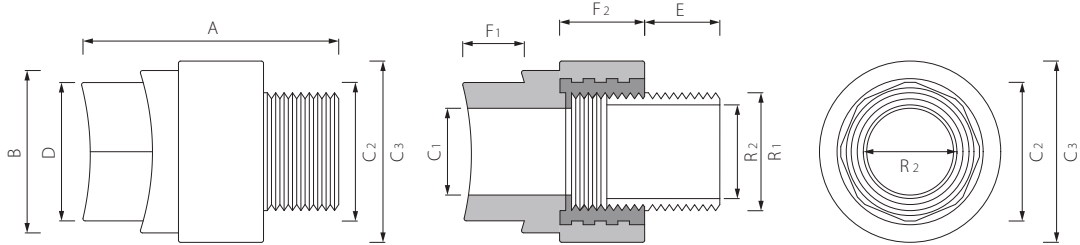

REFERENCE	DIAMETER	A	B	C ₁	C ₂	C ₃	D	E	F ₁	F ₂	R ₁	R ₂	WEIGHT	BAG	BOX	COLOUR
	(mm x in)	(mm)									(in)	(mm)	(kg)	(un)		
P-500063	63-75-90x1/2"	61	38	20	26	43	32	15	10	28	1/2"	16	0,071	20	200	✓
P-500064	63-75-90x3/4"	63	38	20	26	43	32	17	10	28	3/4"	21	0,082	20	200	✓
P-500110	110-125-160x1/2"	63	38	20	26	43	32	15	15	28	1/2"	16	0,073	20	200	✓
P-500111	110-125-160x3/4"	65	38	20	26	43	32	17	15	28	3/4"	21	0,083	20	200	✓

Note: the necessary tools for the fusion of HELIROMA weld-in saddles are listed on pages 142 and 143.

STOP VALVE



CHARACTERISTICS

COLOUR	Green Blue
RAW MATERIAL	PP-R 100 Brass CW617N
TYPE OF WELDING	Socket
STANDARDS	EN ISO 15874 DIN 16962
COMPATIBLE SYSTEMS	HELISYSTEM ROMAFASER ROMAFASER ANTI-UV ROMAKLIMA ROMAFASER CT

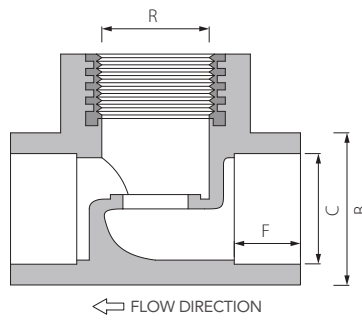
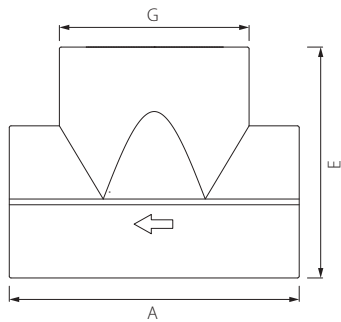

REFERENCE	DIAMETER	A	B	C min	OVALIZATION	E	F	G	R	WEIGHT	BAG	BOX	COLOUR	
	(mm x in)				(mm)				(in)	(kg)		(un)	<input checked="" type="checkbox"/>	<input checked="" type="checkbox"/>
P-244020	20x1/2"	68	29	19,2	14,5	43	15	38	1/2"	0,069	10	100	<input checked="" type="checkbox"/>	<input checked="" type="checkbox"/>
P-244025	25x3/4"	77	47	24,2	16	46	16	45	3/4"	0,098	10	100	<input checked="" type="checkbox"/>	<input checked="" type="checkbox"/>
P-244032	32x1"	80	67	31,1	18	66	18	53	1"	0,160	10	50	<input checked="" type="checkbox"/>	<input checked="" type="checkbox"/>
P-490111	110-125-160x3/4"	50	38	20,0	32	42	38	20	3/4"	0,093	20	200	<input checked="" type="checkbox"/>	<input checked="" type="checkbox"/>

WHEEL VALVE



CHARACTERISTICS

COLOUR	Green Blue
BODY	PP-R 100
THREAD	Brass CW617N
HANDLE	PP-R 100
MECHANISM	Brass CW617N
TYPE OF WELDING	Socket
STANDARDS	EN ISO 15874 DIN 16962
COMPATIBLE SYSTEMS	HELISYSTEM ROMAFASER ROMAFASER ANTI-UV ROMAKLIMA ROMAFASER CT

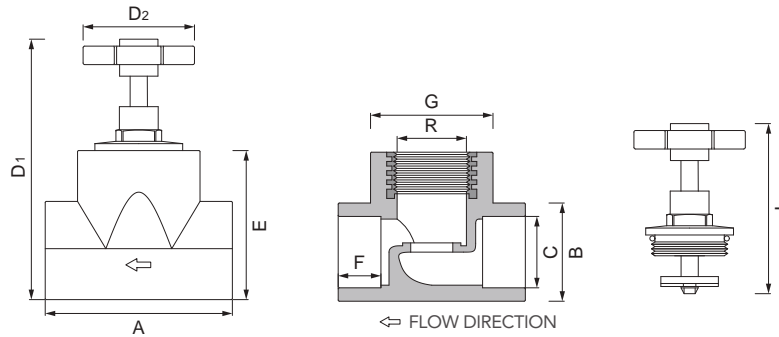

REFERENCE	DIAMETER	A	B	C min	D ₁	D ₂	E	F	G	I	R	WEIGHT	BAG	BOX	COLOUR			
											(in)	(kg)	(un)		●	●		
											(mm)							
P-244020-VLO	20	68	29	19,2	83	53	43	15	38	79	1/2"	0,148	5	50	✓	✓		
P-244025-VLO	25	77	47	24,2	86	53	46	16	45	79	3/4"	0,192	5	50	✓	✓		
P-244032-VLO	32	80	67	31,1	106	53	66	18	53	79	1"	0,283	3	30	✓	✓		

HANDLE VALVE



CHARACTERISTICS

COLOUR	Green Blue
BODY	PP-R 100
THREAD	Brass CW617N
HANDLE	Brass CW617N
HANDLE MECHANISM	Chrome-Plated Brass
MIRROR	Stainless Steel
TYPE OF WELDING	Socket
STANDARDS	EN ISO 15874 DIN 16962
COMPATIBLE SYSTEMS	HELISYSTEM ROMAFASER ROMAFASER ANTI-UV ROMAKLIMA ROMAFASER CT

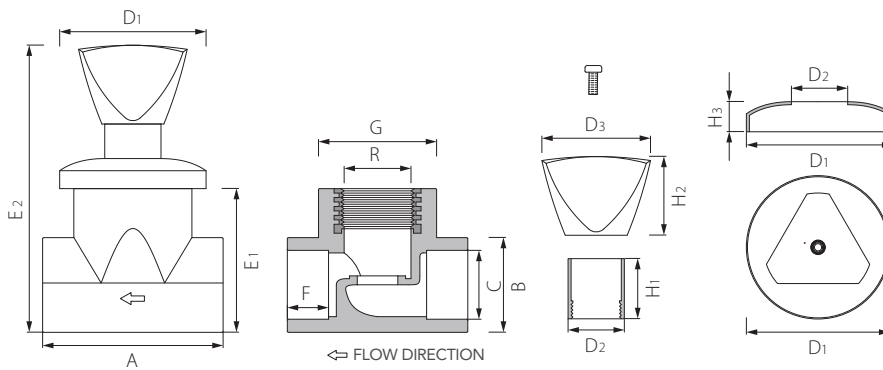

REFERENCE	DIAMETER	A	B	C min	D ₁	D ₂	D ₃	E ₁	E ₂	F	G	H ₁	H ₂	H ₃	R	I	WEIGHT	BAG	BOX	COLOUR	
		(mm)													(in)	(mm)	(kg)	(un)		●	●
P-244020-CP	20	68	29	19,2	64	24	47	43	103	15	38	27	35	13	1/2"	80-100	0,245	5	50	✓	✓
P-244025-CP	25	77	47	24,2	64	24	47	46	106	16	45	27	35	13	3/4"	80-100	0,306	5	50	✓	✓
P-244032-CP	32	80	67	31,1	64	24	47	66	126	18	53	27	35	13	1"	80-100	0,487	3	30	✓	✓

CONCEALED VALVE



CHARACTERISTICS

COLOUR	Green Blue
BODY	PP-R 100
THREAD	Brass CW617N
HANDLE	Brass CW617N
HANDLE MECHANISM	Chrome-Plated Brass
MIRROR	Stainless Steel
TYPE OF WELDING	Socket
STANDARDS	EN ISO 15874 DIN 16962
COMPATIBLE SYSTEMS	HELISYSTEM ROMAFASER ROMAFASER ANTI-UV ROMAKLIMA ROMAFASER CT

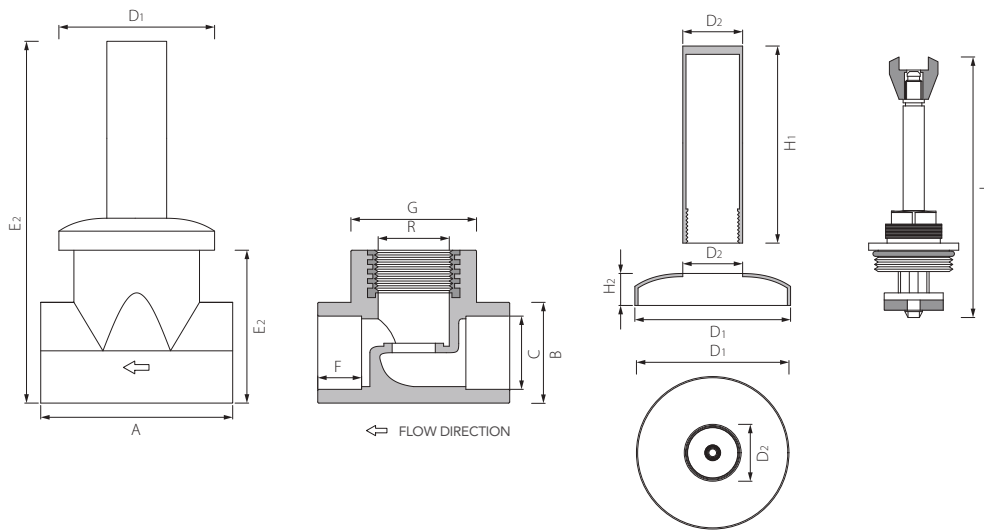

REFERENCE	DIAMETER	A	B	C min	D ₁	D ₂	E	E ₁	F	G	H ₁	H ₂	I	R	WEIGHT	BAG	BOX	COLOUR	
(mm)														(in)	(kg)	(un)	●	●	
P-244020-RO	20	68	29	19,2	64	24	43	89	15	38	41	12	60-70	1/2"	0,186	5	50	✓	✓
P-244025-RO	25	77	47	24,2	64	24	46	92	16	45	41	12	60-70	3/4"	0,245	5	50	✓	✓
P-244032-RO	32	80	67	31,1	64	24	66	112	18	53	41	12	60-70	1"	0,319	3	30	✓	✓

BALL VALVE



CHARACTERISTICS

COLOUR	Green Blue
BODY	PP-R 100
SEAL	PTFE
BALL	Chrome-Plated Brass
HANDLE PLUG	MDPE
PRESSURE CLASS	PN 25 (DN20 - DN75) PN 10 (DN90 - DN125)
TYPE OF WELDING	Socket
STANDARDS	EN ISO 15874 DIN 16962
COMPATIBLE SYSTEMS	HELISYSTEM ROMAFASER ROMAFASER ANTI-UV ROMAKLIMA ROMAFASER CT ROMAKLIMA CT

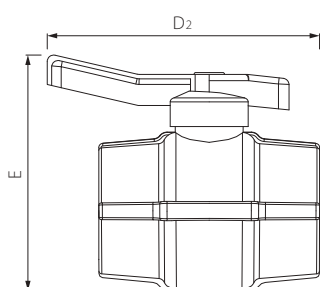

REFERENCE	DIAMETER	A	B	C min	D ₁	D ₂	E	F	WEIGHT	BAG	BOX	COLOUR			
											(mm)	(kg)	(un)		
244020-E	20	74	30	19,2	85	90	75	15	0,126	5	80	✓	✓		
244025-E	25	78	36	24,2	85	100	75	16	0,133	5	50	✓	✓		
244032-E	32	89	45	31,1	108	115	85	18	0,208	5	30	✓	✓		
244040-E	40	98	56	39,0	108	120	105	21	0,362	4	20	✓	✓		
244050-E	50	112	71	48,9	108	125	120	24	0,524	2	16	✓	✓		
244063-E	63	132	90	61,9	150	160	145	28	0,979	1	9	✓	✓		
244075-E	75	151	103	73,7	186	175	170	31	1,421	1	6	✓			
244090-E	90	189	108	88,6	186	340	215	37	2,376	1	4	✓			
2440110-E	110	214	130	108,4	186	350	220	42	3,560	1	2	✓			
2440125-E	125	240	160	122,4	186	365	240	40	4,320	1	1	✓			

DEMOUNTABLE VALVE



CHARACTERISTICS

COLOUR	Green Blue
BODY	PP-R 100
NUT	Brass CW617N
INSERT	PP-R 100
HANDLE	MDPE
TYPE OF WELDING	Socket
STANDARDS	EN ISO 15874 DIN 16962
COMPATIBLE SYSTEMS	HELISYSTEM ROMAFASER ROMAFASER ANTI-UV ROMAKLIMA ROMAFASER CT

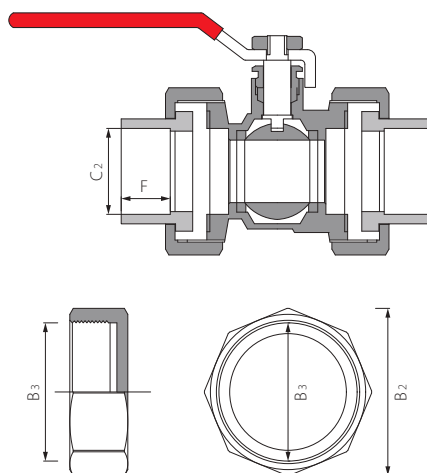
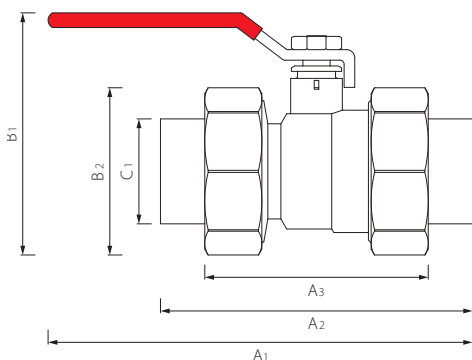

REFERENCE	DIAMETER	A ₁	A ₂	A ₃	B ₁	B ₂	B ₃	C ₁	C ₂	F	WEIGHT	BAG	BOX	COLOUR	
														●	●
(mm)											(kg)	(un)			
P-244020-X	20	127	95	67	65	43	36	28	19	16	0,34	5	70	✓	✓
P-244025-X	25	142	96	68	72	49	42	33	24	17	0,465	5	50	✓	✓
P-244032-X	32	167	104	70	92	61	52	43	31	18	0,712	5	30	✓	✓
P-244040-X	40	192	121	82	111	73	68	50	39	20	1,116	2	20	✓	✓
P-244050-X	50	215	143	97	130	92	85	66	49	23	1,814	2	8	✓	✓

HANDLE VALVE KIT EXTENDER



COMPOSITION OF THE MECHANISM

- UPPER PART Chrome-plated brass
- BODY MECHANISM Brass
- COMPATIBLE FITTINGS Handle valve | Valve w/ handle mechanism

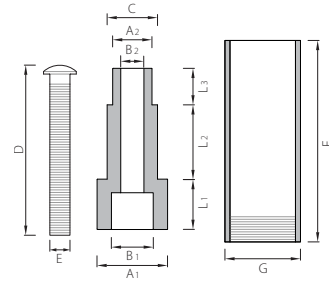

REFERENCE	A ₁	A ₂	B ₁	B ₂	C	D	E	F	G	L ₁	L ₂	L ₃	WEIGHT	BAG	BOX
	(mm)												(kg)	(un)	
KIT2032-CP	13	8	8	4	10	37	4	54	24	10	15	7	0,064	10	150

CONCEALED VALVE KIT EXTENDER



COMPOSITION OF THE MECHANISM

- UPPER PART Chrome-plated brass
- BODY MECHANISM Brass
- COMPATIBLE FITTINGS Full valve mechanism extender
Concealed valve

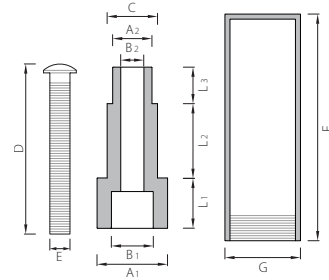

REFERENCE	A ₁	A ₂	B ₁	B ₂	C	D	E	F	G	L ₁	L ₂	L ₃	WEIGHT	BAG	BOX
	(mm)												(kg)	(un)	
KIT2032-RO	13	8	7	4	10	37	4	66	24	12	13	10	0,078	10	150

FULL VALVE MECHANISM EXTENDER



COMPOSITION OF THE MECHANISM

- UPPER PART Nickel-plated brass
- MIRROR Chrome-plated stainless steel
- COMPATIBLE FITTINGS Stop valve

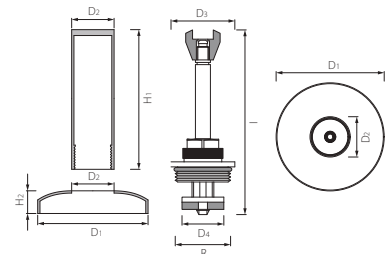

REFERENCE	DIMENSION	D ₁	D ₂	D ₃	D ₄	H ₁	H ₂	I	R	WEIGHT	BAG	BOX
	(in)	(mm)							(in)	(kg)	(un)	
BSPCN12	1/2"	64	24	24	18	41	12	60-70	1/2"	0,12	10	100
BSPCN34	3/4"	64	24	28	22	41	12	60-70	3/4"	0,151	10	100
BSPCN1	1"	64	24	37	27	41	12	60-70	1"	0,168	10	50

VALVE W/ HANDLE MECHANISM



REFERENCE	DIMENSION	BAG	BOX
	(in)		
BSPCP12	1/2"	10	100
BSPCP34	3/4"	10	100
BSPCP1	1"	10	50

COMPOSITION OF THE MECHANISM

HANDLE	Nickel-plated brass
MIRROR	Chrome-plated stainless steel
COMPATIBLE FITTINGS	Stop valve

WHEEL MECHANISM



REFERENCE	DIMENSION	BAG	BOX
	(in)		
BSPCFLO12	1/2"	10	100
BSPCFLO34	3/4"	10	100
BSPCFLO1	1"	10	50

COMPOSITION OF THE MECHANISM

HANDLE	PP-R 100
MECHANISM	Brass CW617N
COMPATIBLE FITTINGS	Stop valve

FEMALE FLANGE ADAPTOR



CHARACTERISTICS

COLOUR	Green Blue
RAW MATERIAL	PP-R 100
TYPE OF WELDING	Socket
STANDARDS	EN ISO 15874 DIN 16962
COMPATIBLE SYSTEMS	HELISYSTEM ROMAFASER ROMAFASER ANTI-UV ROMAKLIMA ROMAFASER CT ROMAKLIMA CT

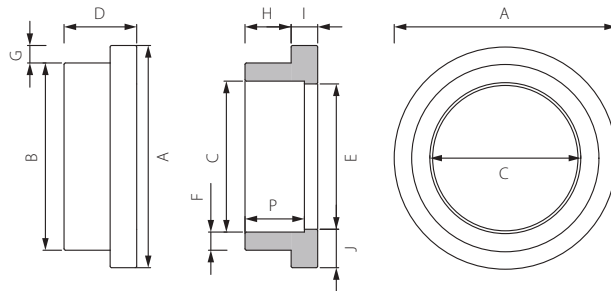

REFERENCE	DIAMETER	A	B	C	Tol. C	D	E	F	G	H	I	J	P	WEIGHT	BAG	BOX	COLOUR	
(mm)														(kg)	(un)		●	●
P-PBRIDA40H	40	77	50	37	+0,4	26	38	7	13	16	10	20	21	0,028	25	100	✓	✓
P-PBRIDA50H	50	87	64	49	+0,5	30	48	8	11	18	12	19	24	0,066	15	60	✓	✓
P-PBRIDA63H	63	100	77	61	+0,6	34	60	9	11	20	14	20	28	0,090	10	30	✓	✓
P-PBRIDA75H	75	113	94	73	+0,5	36	72	11	9	23	13	20	31	0,122	4	20	✓	✓
P-PBRIDA90H	90	133	114	89	+1,5	42	88	13	9	26	16	22	33	0,200	4	20	✓	✓
P-PBRIDA110H	110	159	134	106	+1,7	49	108	15	12	30	19	27	37	0,305	2	10	✓	✓
P-PBRIDA125H	125	188	166	124	+2,2	52	124	21	11	32	20	32	40	0,521	1	10	✓	

FEMALE FLANGE ADAPTOR XL



CHARACTERISTICS

COLOUR	Green
RAW MATERIAL	PP-R 100 PP-RCT 125
TYPE OF WELDING	Butt Welding Electrofusion
STANDARDS	EN ISO 15874 DIN 16962
COMPATIBLE SYSTEMS	ROMAFASER ROMAKLIMA ROMAFASER CT ROMAKLIMA CT

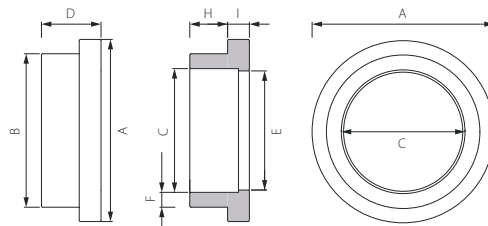

MODEL A

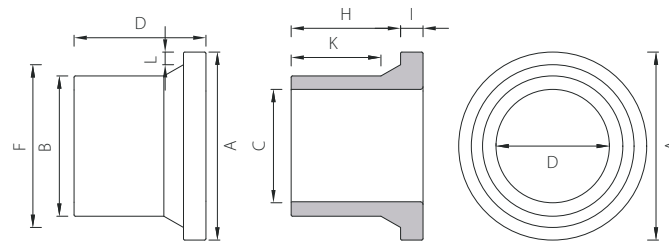

MODEL B

REFERENCE	DIAMETER	A	B	C	D	E	F	H	I	K	MODEL	WEIGHT	BAG	BOX	COLOUR	
												(kg)	(un)			
												(mm)				
P-PBRIDA160H ⁽¹⁾	160	221	160	118	188	151	21	50	25	-	A	1,040	1	1	✓	
CTPBRIDA200H	200	268	200	162	188	162	236	155	33	121	B	2,740	1	1	✓	
CTPBRIDA250H	250	323	250	204	226	204	288	187	39	145	B	4,580	1	1	✓	
CTPBRIDA315H	315	369	315	257	248	257	340	209	39	160	B	7,300	1	1	✓	
CTPBRIDA355H	355	429	355	283	152	284	375	110	42	56	B	6,660	1	1	✓	
CTPBRIDA400H	400	478	400	324	138	324	426	91	47	40	B	8,020	1	1	✓	

⁽¹⁾ Not suitable for electrofusion

FLANGE FOR VALVE



CHARACTERISTICS

COLOUR	Green
RAW MATERIAL	PP-R 100 PP-RCT 125
TYPE OF WELDING	Butt Welding Electrofusion
STANDARDS	EN ISO 15874 DIN 16962
COMPATIBLE SYSTEMS	ROMAFASER ROMAKLIMA ROMAFASER CT ROMAKLIMA CT

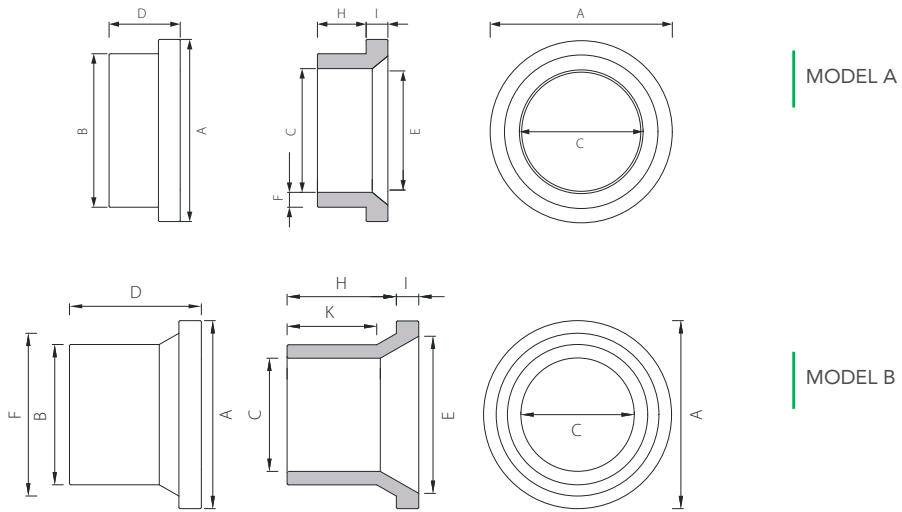

REFERENCE	DIAMETER	A	B	C	D	E	F	H	I	K	MODEL	WEIGHT	BAG	BOX	COLOUR	
												(kg)	(un)			
												(mm)				
P-PBRIDA160-VB ⁽¹⁾	160	221	160	118	188	151	21	50	25	-	A	0,900	1	1	✓	
CTPBRIDA200-VB	200	268	200	162	188	162	236	155	33	121	B	2,580	1	1	✓	
CTPBRIDA250-VB	250	323	250	204	226	204	288	187	39	145	B	4,340	1	1	✓	
CTPBRIDA315-VB	315	369	315	257	248	257	340	209	39	160	B	6,920	1	1	✓	
CTPBRIDA355-VB	355	429	355	283	152	284	375	110	42	56	B	5,960	1	1	✓	
CTPBRIDA400-VB	400	478	400	324	138	324	426	91	47	40	B	7,220	1	1	✓	

⁽¹⁾ Not suitable for electrofusion

STEEL FLANGE



CHARACTERISTICS

RAW MATERIAL	Steel Flange ST 37.2, Zinc Coated
STANDARDS	DIN EN1092 ISO 15494:2015
COMPATIBLE SYSTEMS	HELISYSTEM ROMAFASER ROMAFASER ANTI-UV ROMAKLIMA ROMAFASER CT ROMAKLIMA CT

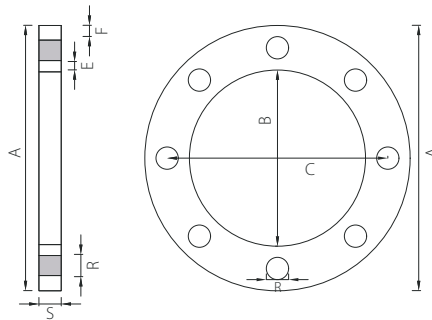

REFERENCE	DIAMETER	A	B	C	E	F	R	S	HOLES	WEIGHT	BAG
		(mm)							(un)	(kg)	(un)
BRIDA40	40	140	52	100	16	11	18	16	4	1,489	1
BRIDA50	50	150	65	110	14	11	18	15	4	1,620	1
BRIDA63	63	165	78	125	14	11	18	18	4	2,221	1
BRIDA75	75	185	95	145	16	12	18	18	4	2,653	1
BRIDA90	90	200	115	160	14	11	18	20	8	2,940	1
BRIDA110	110	220	135	180	13	12	18	21	8	3,440	1

COATED STEEL FLANGE



CHARACTERISTICS

RAW MATERIAL	Carbon Steel Flange ST 37.2, coated with Fiberglass reinforced Polypropylene
STANDARDS	DIN EN1092 ISO 15494:2015
COMPATIBLE SYSTEMS	HELISYSTEM ROMAFASER ROMAFASER ANTI-UV ROMAKLIMA ROMAFASER CT ROMAKLIMA CT

MODEL A

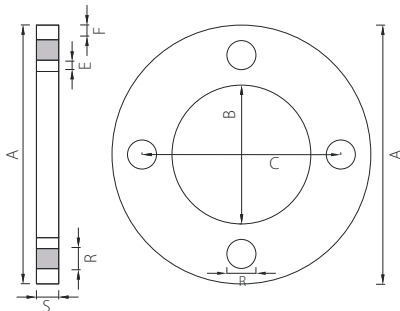

MODEL B

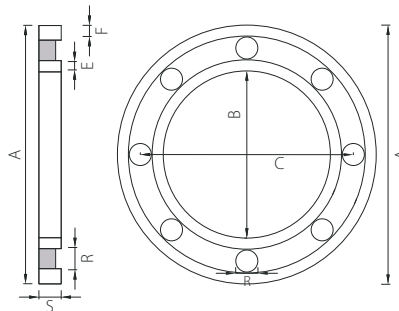

REFERENCE	DIAMETER	A	B	C	E	F	R	S	HOLES	WEIGHT	MODEL	BAG
		(mm)							(un)	(kg)		(un)
BRIDA40-REV	40	142	53	100	15	12	18	18	4	0,671	A	1
BRIDA50-REV	50	152	66	110	13	12	18	18	4	0,767	A/B	1
BRIDA63-REV	63	172	78	125	15	15	18	20	4	1,058	A/B	1
BRIDA75-REV	75	189	95	145	16	13	18	22	4	1,222	A/B	1
BRIDA90-REV	90	200	115	160	14	11	18	20	8	1,100	A/B	1
BRIDA110-REV	110	223	135	179	13	13	18	20	8	1,442	A/B	1
BRIDA125-REV	125	250	168	209	12	12	18	24	8	2,192	A/B	1
BRIDA160-REV	160	287	178	240	20	13	22	24	8	2,740	A/B	1
BRIDA200-REV	200	344	235	295	19	13	23	20	8	4,560	A/B	1
BRIDA250-REV	250	406	288	350	20	17	22	30	12	7,080	A/B	1
BRIDA315-REV	315	465	341	400	19	21	23	34	12	9,780	A/B	1
BRIDA355-REV	355	517	381	460	29	17	23	39	16	15,620	A/B	1
BRIDA400-REV	400	571	429	515	30	15	27	45	16	20,060	A/B	1

CLAMP



CHARACTERISTICS

COLOUR	Green Blue
RAW MATERIAL	PP-R 100
STANDARDS	EN ISO 15874 DIN 16962
COMPATIBLE SYSTEMS	ROMAFASER ROMAKLIMA ROMAFASER CT ROMAKLIMA CT

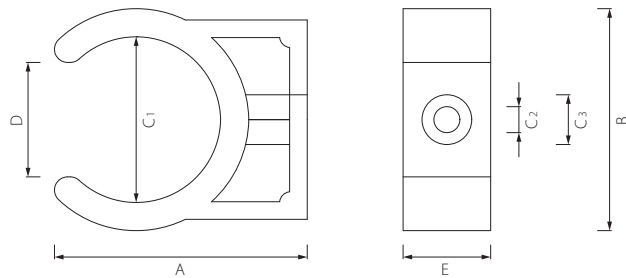

REFERENCE	DIAMETER	A	B	C ₁	C ₂	C ₃	D	E	WEIGHT	BAG	BOX	COLOUR		
									(kg)	(un)		Green	Blue	
									(mm)					
AB20	20	20	26	19	10	6	14	8	0,004	100	1000	✓	✓	
AB25	25	36	32	24	10	6	17	13	0,006	100	800	✓	✓	
AB32	32	45	41	31	10	6	24	16	0,011	50	500	✓	✓	
AB40	40	57	51	38	10	6	26	20	0,020	30	240	✓	✓	

END CAP



CHARACTERISTICS

COLOUR	Green Blue
RAW MATERIAL	PP-R 100
TYPE OF WELDING	Socket
STANDARDS	EN ISO 15874 DIN 16962
COMPATIBLE SYSTEMS	HELISYSTEM ROMAFASER ROMAFASER ANTI-UV ROMAKLIMA ROMAFASER CT ROMAKLIMA CT

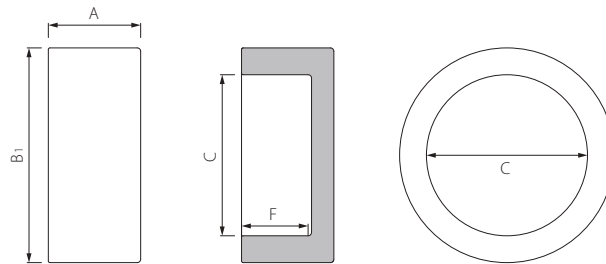

REFERENCE	DIAMETER	A	B ₁	C min	F	WEIGHT	BAG	BOX	COLOUR	
									Green	Blue
						(kg)	(un)			
P-242020	20	20	28	19,2	15	0,013	50	500	✓	✓
P-242025	25	22	34	24,2	16	0,017	50	500	✓	✓
P-242032	32	26	42	31,1	18	0,023	30	240	✓	✓
P-242040	40	29	53	39,0	21	0,036	20	200	✓	✓
P-242050	50	32	68	48,9	24	0,065	10	100	✓	✓
P-242063	63	42	87	61,9	28	0,150	5	50	✓	✓
P-242075	75	43	100	73,7	30	0,186	2	40	✓	✓
P-242090	90	53	122	88,6	33	0,346	1	24	✓	✓
P-2420110	110	61	144	108,4	37	0,504	1	10	✓	✓
P-2420125	125	68	162	122,4	40	0,702	1	10	✓	

END CAP XL



CHARACTERISTICS

COLOUR	Green
RAW MATERIAL	PP-R 100
TYPE OF WELDING	Butt Welding Electrofusion
STANDARDS	EN ISO 15874 DIN 16962
COMPATIBLE SYSTEMS	ROMAFASER ROMAKLIMA ROMAFASER CT ROMAKLIMA CT

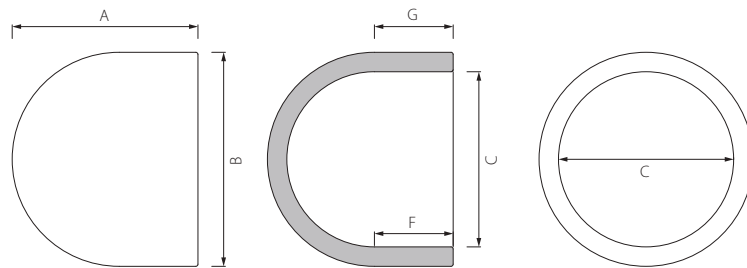

REFERENCE	DIAMETER	A	B	C	F	G	WEIGHT	BAG	BOX	COLOUR
(mm)							(kg)	(un)		
P-2420160 ⁽¹⁾	160	73	161	115,2	47	-	0,910	1	8	✓
CT2420200	200	180	200	164	96	120	1,980	1	1	✓
CT2420250	250	217	250	205	115	135	3,120	1	1	✓
CT2420315	315	256	315	258	143	161	-	1	1	✓

⁽¹⁾ Not suitable for electrofusion

THREADED END CAP



CHARACTERISTICS

COLOUR	Green
RAW MATERIAL	PP-R 100
TYPE OF WELDING	Socket
STANDARDS	EN ISO 15874 DIN 16962
COMPATIBLE SYSTEMS	HELISYSTEM ROMAFASER ROMAFASER ANTI-UV ROMAKLIMA ROMAFASER CT

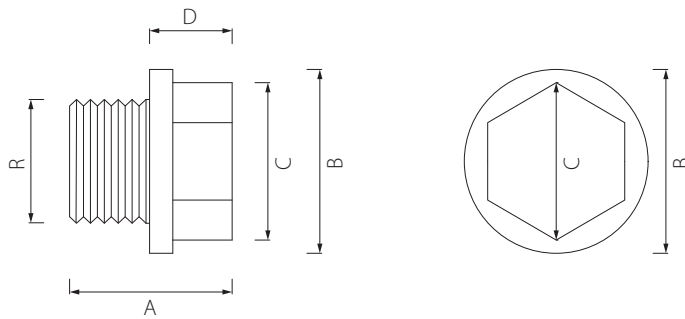

REFERENCE	DIMENSIONS	A	B	C	D	R	WEIGHT	BAG	BOX	COLOUR
	(in)	(mm)				(in)	(kg)	(un)		
P-237020	1/2"	25	28	21	13	1/2"	0,008	100	1000	✓
P-237025	3/4"	28	32	24	13,5	3/4"	0,013	-	-	✓

BRIDGE



CHARACTERISTICS

COLOUR	Green Blue
RAW MATERIAL	PP-R 100
TYPE OF WELDING	Socket
STANDARDS	EN ISO 15874 DIN 16962
COMPATIBLE SYSTEMS	HELISYSTEM ROMAFASER ROMAFASER ANTI-UV ROMAKLIMA ROMAFASER CT

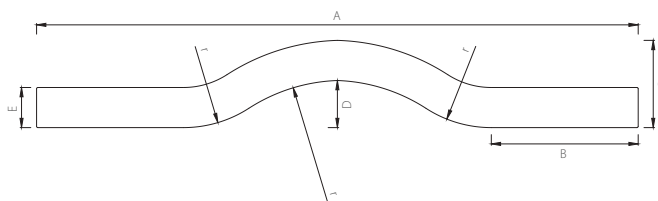

REFERENCE	DIAMETER	A	B	C	D	E	R	WEIGHT	BAG	BOX	COLOUR	
											●	●
		(mm)						(kg)	(un)			
P-UC20	20	300	80	42	22	20	61,2	0,065	10	100	✓	✓
P-UC25	25	330	75	52	27	25	81,8	0,098	10	60	✓	✓
P-UC32	32	380	80	64	34	32	97,5	0,16	5	40	✓	✓

REPAIR PIN



CHARACTERISTICS

COLOUR	Green Blue
RAW MATERIAL	PP-R 100
TYPE OF WELDING	Socket
STANDARDS	EN ISO 15874 DIN 16962
COMPATIBLE SYSTEMS	HELISYSTEM ROMAFASER ROMAFASER ANTI-UV ROMAKLIMA ROMAFASER CT ROMAKLIMA CT

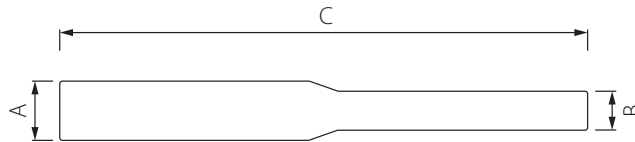

REFERENCE	DIAMETER	A	B	C	WEIGHT	BAG	BOX	COLOUR	
		(mm)			(kg)	(un)		<input checked="" type="checkbox"/>	<input checked="" type="checkbox"/>
P-4501	7/11	11,4	7,5	101,5	0,008	50	1000	✓	✓

PP-R ELECTROFUSION FITTINGS

- ELECTROFUSION FITTINGS
- FITTINGS FOR ELECTROFUSION

ELBOW 45°



CHARACTERISTICS

COLOUR	Green
RAW MATERIAL	PP-R 100
TYPE OF WELDING	Electrofusion
WELD INTENSITY	39,5 Volts
STANDARDS	EN ISO 15874 DIN 16962
COMPATIBLE SYSTEMS	HELISYSTEM ROMAFASER ROMAFASER ANTI-UV ROMAKLIMA ROMAFASER CT ROMAKLIMA CT

REFERENCE	DIAMETER	BOX
	(mm)	(un)
ES202063	63	40
ES202090	90	15
ES2020110	110	12
ES2020125	125	6
ES2020160	160	4

ELBOW 90°



CHARACTERISTICS

COLOUR	Green
RAW MATERIAL	PP-R 100
TYPE OF WELDING	Electrofusion
WELD INTENSITY	39,5 Volts
STANDARDS	EN ISO 15874 DIN 16962
COMPATIBLE SYSTEMS	HELISYSTEM ROMAFASER ROMAFASER ANTI-UV ROMAKLIMA ROMAFASER CT ROMAKLIMA CT

REFERENCE	DIAMETER	BOX
	(mm)	(un)
ES206063	63	36
ES206075	75	20
ES206090	90	12
ES2060110	110	8
ES2060125	125	6
ES2060160	160	4

TEE



CHARACTERISTICS

COLOUR	Green
RAW MATERIAL	PP-R 100
TYPE OF WELDING	Electrofusion
WELD INTENSITY	39,5 Volts
STANDARDS	EN ISO 15874 DIN 16962
COMPATIBLE SYSTEMS	HELISYSTEM ROMAFASER ROMAFASER ANTI-UV ROMAKLIMA ROMAFASER CT ROMAKLIMA CT

REFERENCE	DIAMETER	BOX
	(mm)	(un)
ES230063	63	24
ES230075	75	18
ES230090	90	10
ES2300110	110	8
ES2300125	125	5
ES2300160	160	2

UNION



CHARACTERISTICS

COLOUR	Green
RAW MATERIAL	PP-R 100
TYPE OF WELDING	Electrofusion
WELD INTENSITY	39,5 Volts
STANDARDS	EN ISO 15874 DIN 16962
COMPATIBLE SYSTEMS	HELISYSTEM ROMAFASER ROMAFASER ANTI-UV ROMAKLIMA ROMAFASER CT ROMAKLIMA CT

REFERENCE	DIAMETER	BOX
	(mm)	(un)
ES200025	25	200
ES200032	32	70
ES200040	40	150
ES200050	50	120
ES200063	63	60
ES200075	75	18
ES200090	90	10
ES2000110	110	16
ES2000125	125	12
ES2000160	160	6
ES2000200	200	1
ES2000250	250	1
ES2000315	315	1

REDUCER UNION



CHARACTERISTICS

COLOUR	Green
RAW MATERIAL	PP-R 100
TYPE OF WELDING	Electrofusion
WELD INTENSITY	39,5 Volts
STANDARDS	EN ISO 15874 DIN 16962
COMPATIBLE SYSTEMS	HELISYSTEM ROMAFASER ROMAFASER ANTI-UV ROMAKLIMA ROMAFASER CT ROMAKLIMA CT

REFERENCE	DIAMETER	BOX
	(mm)	(un)
ES238065	63x32	49
ES238063	63x40	49
ES238067	63x50	49
ES238076	75x63	49
ES238096	90x63	30
ES2380116	110x63	16
ES2380110	110x75	16
ES2380117	110x90	16
ES2380126	125x90	12
ES2380161	160x110	6

FEMALE FLANGE ADAPTOR



CHARACTERISTICS

COLOUR	Green
RAW MATERIAL	PP-R 100 PP-RCT 125
TYPE OF WELDING	Electrofusion
STANDARDS	EN ISO 15874 DIN 16962
COMPATIBLE SYSTEMS	HELISYSTEM ROMAFASER ROMAFASER ANTI-UV ROMAKLIMA ROMAFASER CT ROMAKLIMA CT EF FITTINGS

REFERENCE	DIAMETER	BOX
	(mm)	(un)
P-LESPBRIDA110H	110	1
P-LESPBRIDA125H	125	1
P-LESPBRIDA160H	160	1

FLANGE FOR VALVE



CHARACTERISTICS

COLOUR	Green
RAW MATERIAL	PP-R 100 PP-RCT 125
TYPE OF WELDING	Electrofusion
STANDARDS	EN ISO 15874 DIN 16962
COMPATIBLE SYSTEMS	HELISYSTEM ROMAFASER ROMAFASER ANTI-UV ROMAKLIMA ROMAFASER CT ROMAKLIMA CT EF FITTINGS

REFERENCE	DIAMETER	BOX
	(mm)	(un)
P-LESPBRIDA160	160	1

ELBOW 45°



CHARACTERISTICS

COLOUR	Green
RAW MATERIAL	PP-R 100 PP-RCT 125
TYPE OF WELDING	Electrofusion
STANDARDS	EN ISO 15874 DIN 16962
COMPATIBLE SYSTEMS	HELISYSTEM ROMAFASER ROMAFASER ANTI-UV ROMAKLIMA ROMAFASER CT ROMAKLIMA CT EF FITTINGS

REFERENCE	DIAMETER	BOX
	(mm)	(un)
P-LES2020110	110	1
P-LES2020125	125	1
P-LES2020160	160	1

ELBOW 90°



CHARACTERISTICS

COLOUR	Green
RAW MATERIAL	PP-R 100 PP-RCT 125
TYPE OF WELDING	Electrofusion
STANDARDS	EN ISO 15874 DIN 16962
COMPATIBLE SYSTEMS	HELISYSTEM ROMAFASER ROMAFASER ANTI-UV ROMAKLIMA ROMAFASER CT ROMAKLIMA CT EF FITTINGS

REFERENCE	DIAMETER	BOX
	(mm)	(un)
P-LES2060110	110	1
P-LES2060125	125	1
P-LES2060160	160	1

FEMALE UNION



CHARACTERISTICS

COLOUR	Green
RAW MATERIAL	PP-R 100 PP-RCT 125 Brass CW617N
TYPE OF WELDING	Electrofusion
STANDARDS	EN ISO 15874 DIN 16962
COMPATIBLE SYSTEMS	HELISYSTEM ROMAFASER ROMAFASER ANTI-UV ROMAKLIMA ROMAFASER CT ROMAKLIMA CT EF FITTINGS

REFERENCE	DIAMETER	BOX
	(mm)	(un)
P-LES234075	75	1
P-LES234090	90	1
P-LES2340110	110	1

MALE UNION



CHARACTERISTICS

COLOUR	Green
RAW MATERIAL	PP-R 100 PP-RCT 125 Brass CW617N
TYPE OF WELDING	Electrofusion
STANDARDS	EN ISO 15874 DIN 16962
COMPATIBLE SYSTEMS	HELISYSTEM ROMAFASER ROMAFASER ANTI-UV ROMAKLIMA ROMAFASER CT ROMAKLIMA CT EF FITTINGS

REFERENCE	DIAMETER	BOX
	(mm)	(un)
P-LES325075	75	1
P-LES325090	90	1
P-LES3250110	110	1

TEE



CHARACTERISTICS

COLOUR	Green
RAW MATERIAL	PP-R 100 PP-RCT 125
TYPE OF WELDING	Electrofusion
STANDARDS	EN ISO 15874 DIN 16962
COMPATIBLE SYSTEMS	HELISYSTEM ROMAFASER ROMAFASER ANTI-UV ROMAKLIMA ROMAFASER CT ROMAKLIMA CT EF FITTINGS

REFERENCE	DIAMETER	BOX
	(mm)	(un)
P-LES2300110	110	1
P-LES2300125	125	1
P-LES2300160	160	1

END CAP



CHARACTERISTICS

COLOUR	Green
RAW MATERIAL	PP-R 100 PP-RCT 125
TYPE OF WELDING	Electrofusion
STANDARDS	EN ISO 15874 DIN 16962
COMPATIBLE SYSTEMS	HELISYSTEM ROMAFASER ROMAFASER ANTI-UV ROMAKLIMA ROMAFASER CT ROMAKLIMA CT EF FITTINGS

REFERENCE	DIAMETER	BOX
	(mm)	(un)
P-LES2420110	110	1
P-LES2420125	125	1
P-LES2420160	160	1



PP-R TOOLS

POLYWELDER SET A



REFERENCE	DIAMETER	BOX
	(mm)	(un)
POLIR1	20-32	1
POLIR2	20-63	1

POLYWELDER



REFERENCE	DIAMETER	BOX
	(mm)	(un)
POLI110	16-110	1
POLIR-125	16-125	1

BENCH POLIWELDER SET



REFERENCE	DIAMETER	BOX
	(mm)	(un)
POLIR125	40-125	1

POLIWELDER TOP



REFERENCE	DIAMETER	BOX
	(mm)	(un)
POL160TOP	40-160	1
POL1250TOP	90-250	1
POL1315TOP	90-315	1
POL1500TOP	200-500	1

ELECTROFUSION POLIWELDER



REFERENCE	BOX
	(un)
HST300P450	1

ROTARY SCRAPER



REFERENCE	DIAMETER	BOX
	(mm)	(un)
RASP-T200	63-200	1

PP-R SHEAR



REFERENCE	DIAMETER	BOX
	(mm)	(un)
TES 40	16-40	1
TES 63	16-63	1
TES 75	16-75	1

REPAIR BUSH



REFERENCE	DIAMETER	BOX
	(mm)	(un)
MR-07	7	1
MR-11	11	1

BUSHES



REFERENCE	DIAMETER	BOX
	(mm)	(un)
MTR-20	20	1
MTR-25	25	1
MTR-32	32	1
MTR-40	40	1
MTR-50	50	1
MTR-63	63	1
MTR-75	75	1
MTR-90	90	1
MTR-110	110	1
MTR-125	125	1

DERIVATION BUSH



REFERENCE	DIAMETER	BOX
	(mm)	(un)
DMTR6325	63x25/20	1
DMTR7525	75x25/20	1
DMTR9025	90x25/20	1
DMTR11025	110x25/20	1
DMTR12525	125x25/20	1
DMTR16025	160x25/20	1
DMTR6332	63x32	1
DMTR7532	75x32	1
DMTR9032	90x32	1
DMTR11032	110x32	1
DMTR12532	125x32	1
DMTR16032	160x32	1

DERIVATION DRILL BIT



REFERENCE	DIAMETER	BOX
	(mm)	(un)
BR-25	25/20	1
BR-32	32	1

CALIBRATOR



REFERENCE	DIAMETER	BOX
	(mm)	(un)
ESDMTR-25	25/20	1
ESDMTR-32	32	1





RED FIRE

2

RED FIRE SYSTEM

INSTALLATION GUIDELINES

WELDING TECHNOLOGY

SYSTEM GENERAL ADVANTAGES

CERTIFICATIONS

PRODUCT RANGE

- RED FIRE pipe
- RED FIRE Fittings

RED FIRE SYSTEM

RED FIRE PIPE AND FITTINGS



CHARACTERISTICS



B-s1,d0



SPRINKLERS



FIRE PROTECTION NETWORK



UV PROTECTION



100% RECYCLABLE



ECO-FRIENDLY

PLASTIC PIPES CLASSIFICATION

SDR Standard dimension ratio – ratio between pipe's outside diameter and it's wall thickness.

$$SDR = \frac{d_e}{e}$$

S Series - dimensionless index, which is used for the calculation of the wall thickness of the pipe.

$$S = \frac{d_e - e}{2e}$$

d_e Outside diameter of the pipe

e Wall thickness of the pipe

MATERIAL

PP Polypropylene

PP-R Polypropylene Random

PP-R 100 Polypropylene Random 100

FG Fiberglass

PRODUCT RANGE OVERVIEW

RED FIRE
 PP-R 100+ FG
 SDR 11
 Ø20 - Ø125

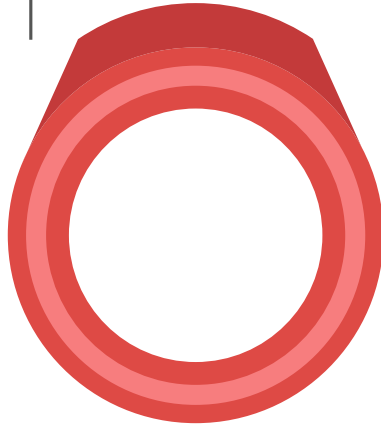

RED FIRE PIPE AND FITTINGS

DIAMETERS (mm)	20	25	32	40	50	63	75	90	110	125
RED FIRE PIPE	✓	✓	✓	✓	✓	✓	✓	✓	✓	✓
RED FIRE FITTINGS	✓	✓	✓	✓	✓	✓	✓	✓	✓	✓



RED FIRE SYSTEM

HELIROMA RED FIRE is a piping system made of PP-R with fiberglass specially developed for fire suppression. The RED FIRE system is suitable for applications on fire hydrants and sprinkler systems.

RED FIRE pipe is manufactured using raw-material PP-R MRS 10.0 and fiberglass, SDR 11, Series 5.0 and based on a 3-layer structure: internal layer made of PP-R 100; middle layer made of PP-R 100 with fiberglass and external layer made of PP-R 100. All layers have fire retardant additive integration, which grants fire resistance to the pipe. RED FIRE is resistant to UV radiation. The product is supplied in red colour.

Fittings are manufactured using PP-R raw material with flame retardant additive.

HELIROMA offers an wide range of pipes and fittings for fire Fire Protection Systems. RED FIRE is a reliable fire protection system which grants maximum security.

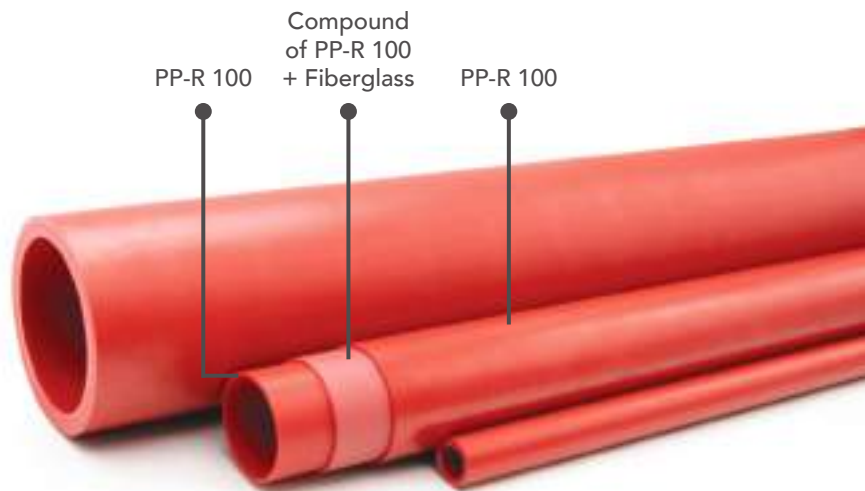

REACTION TO FIRE CLASSIFICATION: B-s1,d0

According to applicable standard EN 13501, it is rated B-s1,d0 for fire resistance class, which is the best fire resistance classification that a polymeric material can achieve.

General Classification

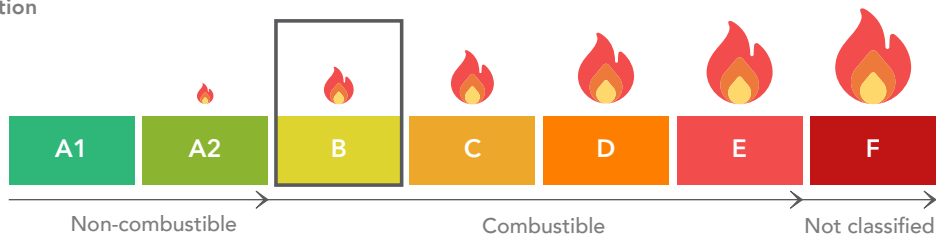

Additional classification

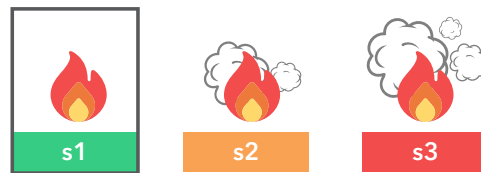

Smoke emission level: values range from s1 (absent/weak) to s3 (high)

























Flaming Droplets and/or particles production: values range from d0 (absent) to d2 (high)

RED FIRE has a certificate of conformity for Sprinklers and BIE's by AENOR and a FM Approval (FM) for wet pipe automatic sprinkler systems in HC-1 Occupancies.

RED FIRE: RAW MATERIAL AND PIPE PROPERTIES

PARAMETER	VALUE	STANDARD
PHYSICAL		
Density	897 kg/m ³	ISO 1133
MFI 230°C/2,16 kg	0,3 g/10min	ISO 1133
Roughness	0,007 mm	ISO 5436
Opacity	Yes	ISO 7686
MECHANICAL		
Tensile Modulus	850 MPa	ISO 527
Tensile Stress At Yield	25 MPa	ISO 527
MRS Classification	10.0 MPa	ISO 9080
THERMAL		
Vicat Temperature (A50)	132°C	ISO 306
Thermal expansion coefficient	0,035 mm/m°C	VDE 0304
Thermal Conductivity (at 20°C)	0,135 W/m K	DIN 52612
DSC Melting Point	139°C	DSC
Fire classification	B-s1,d0	EN13501

ADVANTAGES AND KEY FEATURES OF RED FIRE

- | | | | |
|---|---|---|---|
|  | FIRE RESISTANCE CLASS B-s1, d0 |  | LONG LIFE EXPECTANCY |
|  | PREVENTS SPRINKLERS CLOGGING |  | HIGH CHEMICAL RESISTANCE |
|  | LOW MAINTENANCE |  | CORROSION RESISTANT |
|  | LOW INSTALLATION COSTS |  | PREVENTS LIMESCALE |
|  | EASY AND SAFE ASSEMBLY |  | HIGH RESISTANCE TO ABRASION |
|  | SHORT PROCESSING TIME |  | LOW ROUGHNESS |
|  | LIGHTWEIGHT |  | LOW PRESSURE LOSS |
|  | WELD-IN SADDLE |  | REDUCED THERMAL EXPANSION |
|  | LEAK-PROOF CONNECTION OF PIPE-FITTING |  | FEWER SUPPORTS NEEDED |
|  | NO SEALANTS OR ADHESIVES ARE REQUIRED FOR JOINS |  | HIGH IMPACT RESISTANCE |
|  | EXTREMELY RELIABLE |  | NATIONAL AND INTERNATIONAL CERTIFICATIONS |



APPLICATION AREAS

FIRE HYDRANTS

RED FIRE can be installed in ordinary hazard (OH) and medium hazards areas (MH), according to standard UNE 671 and RD 513/2017.

Technical Building Code allows the use for standard 25 mm and 45 mm equipped fire hydrants on the following areas:

- Administrative and school buildings (area > 2000 m²);
- Hospitals;
- Commercial, area > 500 m²;
- Public Buildings, area > 500 m²;
- Parkings, area > 500 m² (excluding robotic parking)
- Residential buildings, area > 1000 m², or facilities designed to accommodate more than 50 people.

System can be used as long as there are at least 2 equipped fire hydrants for a minimum of 60 minutes and a nozzle pressure of 2 bar, in the previous application areas.



RED FIRE SYSTEM

Suitable for wet pipe installations, permanently charged with pressurized water.

SPRINKLERS

RED FIRE can only be installed with sprinklers for wet systems, as defined in EN 12845 for buildings classified as light risk (LR) and ordinary risk (OR1, OR2, OR3 and OR4).

In branched networks with sprinklers, shut-off valves or flow prevention mechanisms cannot be used downstream of the control station.

Light risk (LR)

LR includes activities with low fire loads, low combustibility and with no compartment larger than 126 m² with a fire resistance of at least 30 minutes. Examples: Schools, Offices, Penitentiary centres.

Ordinary risk (OR)

OR includes activities where combustible materials with a medium fire load and medium combustibility is processed or manufactured. Examples: Teaching centres, residential buildings, hospitals, shopping centres, public buildings, hotels, industrial buildings.



RISK LEVEL				
LOW RISK	LR	LR	<input checked="" type="checkbox"/>	<input type="checkbox"/>
		MR 1	<input checked="" type="checkbox"/>	<input type="checkbox"/>
MEDIUM RISK	MR	MR2	<input checked="" type="checkbox"/>	<input type="checkbox"/>
		MR3	<input checked="" type="checkbox"/>	<input type="checkbox"/>
		MR 4	<input checked="" type="checkbox"/>	<input type="checkbox"/>
		EPR 1	<input type="checkbox"/>	<input checked="" type="checkbox"/>
EXTRA PROCESS RISK	EPR	EPR 2	<input type="checkbox"/>	<input checked="" type="checkbox"/>
		EPR 3	<input type="checkbox"/>	<input checked="" type="checkbox"/>
		EPR 4	<input type="checkbox"/>	<input checked="" type="checkbox"/>
		ESR 1	<input type="checkbox"/>	<input checked="" type="checkbox"/>
EXTRA STORAGE RISK	ESR	ESR 2	<input type="checkbox"/>	<input checked="" type="checkbox"/>
		ESR 3	<input type="checkbox"/>	<input checked="" type="checkbox"/>
		ESR 4	<input type="checkbox"/>	<input checked="" type="checkbox"/>



RED FIRE SYSTEM

Suitable for wet pipe installations, permanently charged with pressurized water.

PERMISSIBLE WORKING PRESSURE

Non potable water applications - closed systems

TEMPERATURE (°C)	PERMISSIBLE WORKING PRESSURE (bar)	
	LIFETIME (years)	RED FIRE PP-R 100 + FG SDR 11 S5.0
10	50	18,2
20		15,4
30		13,0
40		11,0
50		9,2

Safety factor - 1,25.

PIPE MARKING

The following sequence must be printed once per meter in all pipes.

Example:

HR HELIROMA RED FIRE AENOR CC 001/691 opaco (PP-R / PP-R +GF / PP-R) Ø 90x8.2 mm SDR 11 SERIE 5 CLASSE 1/6 2/4 4/6 bar DIN 8077 / 8078 GERMANY standards L DD/MM/YY HH:MM OP Made in Portugal

MARKED SYMBOL	DESCRIPTION
HR HELIROMA	Manufacturer's name
RED FIRE	Product trade mark
AENOR CC 001/691	Certificates, Approvals
Opaco	Opacity
PP-R /PP-R +GF/PP-R	Material
$d_e \times e$	Nominal outside diameter x Nominal wall thickness
SDR 11	SDR of the pipe
SERIE 5	Pipe series S
1/6 2/4 4/6 bar	Application class combined with operating pressure
DIN 8077 / 8078	Standards
L	Machine number
DD/MM/YY HH:MM	Date of manufacture
OP	Production order number
Made in Portugal	Manufacturer information

INSTALLATION GUIDELINES

Please refer to the section **INSTALLATION GUIDELINES** under PP-R section on page 45 of this Technical Catalogue.



WELDING TECHNOLOGY

In order to obtain good installation results of RED FIRE systems, the following recommendations are considered important by HELIROMA and should be taken into consideration, as well as the welding technique and linear expansion.

Please refer to the section **WELDING TECHNOLOGY** under PP-R section on page 56 of this Technical Catalogue.



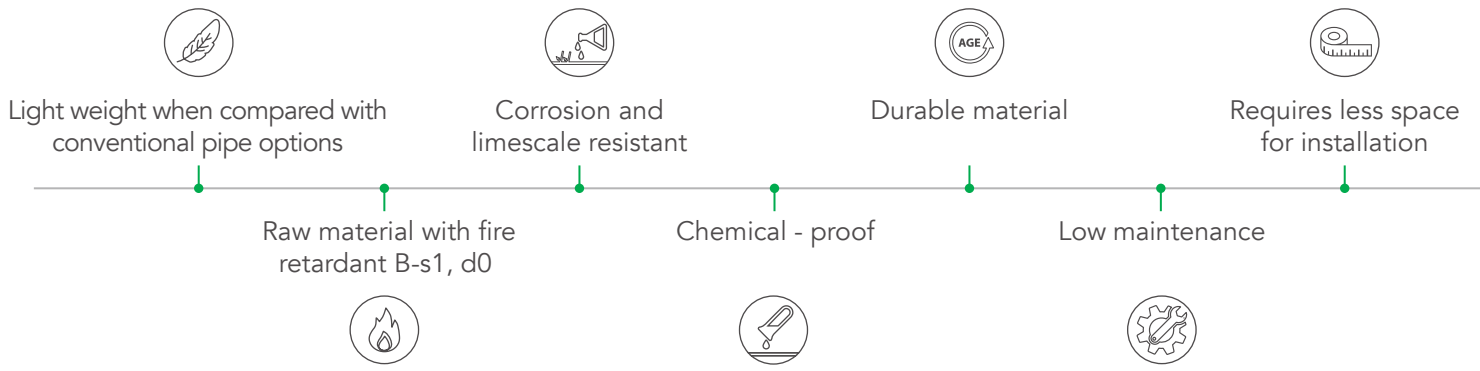

SYSTEM GENERAL ADVANTAGES

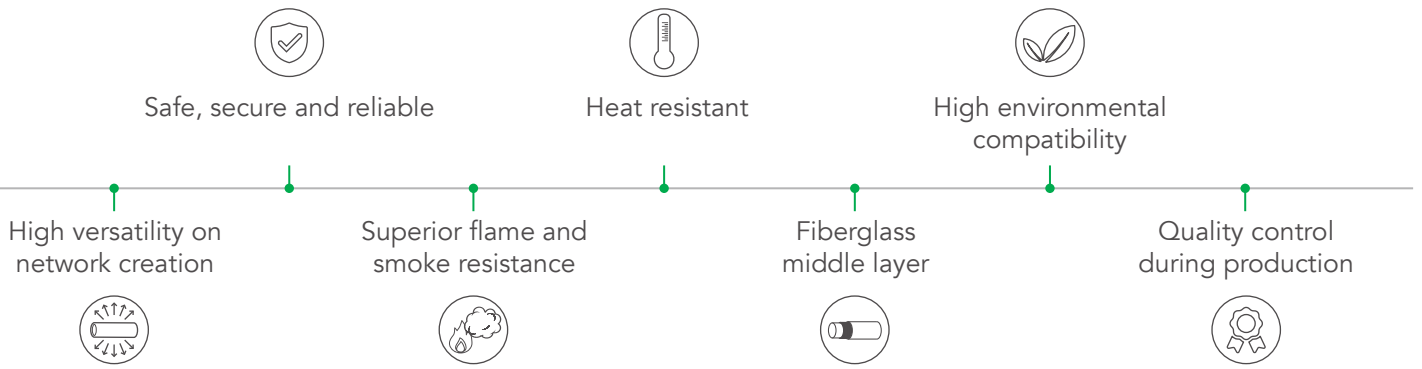

CERTIFICATIONS

Fire protection requirements and standards for planning and construction of sprinkler systems vary locally. Thus, the application of HELIROMA RED FIRE in any case has to be agreed and coordinated with the local national fire protection authorities, the constructor and the building insurers.

The following national and international standards, regulations and listings are applicable to HELIROMA RED FIRE piping system:

STANDARDS:

EN 12845: Fixed firefighting systems - Automatic sprinkler systems - Design, installation and maintenance.

EN 671: Fixed firefighting systems - Hose systems.

EN 13501-1:2007: Fire classification of construction products and building elements.

EN 13238: Reaction to fire tests for building products - Conditioning procedures and general rules for selection of substrates.

EN ISO 11925 - 2:2011: Reaction to fire tests - Ignitability of products subjected to direct impingement of flame - Part 2: Single-flame source test.

EN ISO 15874: Plastics piping systems for hot and cold water installations - Polypropylene (PP).

DIN 8077: Polypropylene (PP) pipes - PP-H, PP-B, PP-R, PP-RCT - Dimensions.

DIN 8078: Polypropylene (PP) pipes - PP-H, PP-B, PP-R, PP-RCT - General quality requirements and testing.

RP 01.84: Plastic Piping systems of polypropylene random or polypropylene random with modified crystallinity and glass fiber (GF) for firefighting installations.

NFPA 13: Standard for the Installation of Sprinkler Systems.

FACTORY MUTUAL APPROVALS 1635: Plastic Pipe and Fittings for Wet Automatic Sprinkler Systems in HC-1 Occupancies.





RED FIRE | PRODUCT RANGE

- RED FIRE PIPE
- RED FIRE FITTINGS

RED FIRE PIPE

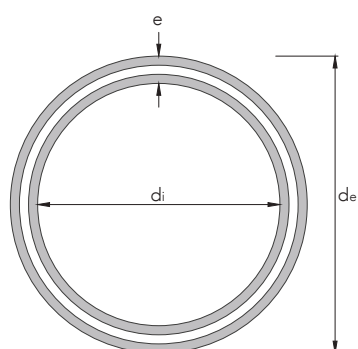

CHARACTERISTICS

COLOUR	Red
SUPPLIED IN	4 m bars
TYPE OF WELDING	Socket Butt Welding
SERIES	5.0
STANDARDS	EN ISO-15874 EN 13501 EN 671 EN 12845 DIN 8077 DIN 8078 RP 001.72 RP 001.84



REFERENCE	d _n NOMINAL DIAMETER	d _e OUTSIDE DIAMETER		e THICKNESS		d _i INSIDE DIAMETER		WEIGHT	MAX WEIGHT W/ WATER *
		Min.	Max.	Min.	Max.	Min.	Max.		
								(kg/m)	
P-14020-RF	20 SDR 7,4	20,0	20,3	2,8	3,2	13,6	14,7	0,153	0,323
P-14025-RF	25 SDR 7,4	25,0	25,3	3,5	4,0	17,0	18,3	0,246	0,509
P-14032-RF	32	32,0	32,3	2,9	3,3	25,4	26,5	0,278	0,830
P-14040-RF	40	40,0	40,4	3,7	4,2	31,6	33,0	0,422	1,277
P-14050-RF	50	50,0	50,5	4,6	5,2	39,6	41,3	0,644	1,984
P-14063-RF	63	63,0	63,6	5,8	6,5	50,0	52,0	1,034	3,158
P-14075-RF	75	75,0	75,7	6,8	7,6	59,8	62,1	1,500	4,529
P-14090-RF	90	90,0	90,9	8,2	9,2	71,6	74,5	2,200	6,559
P-140110-RF	110	110,0	111,0	10,0	11,1	87,8	91,0	3,122	9,626
P-140125-RF	125	125,0	126,2	11,4	12,7	99,6	103,4	4,020	12,417

* Water max. weight calculated with ρ_{H₂O} at 4°C;



RED FIRE FITTINGS

ELBOW 45°



CHARACTERISTICS

COLOUR	Red
RAW MATERIAL	PP-R 100 PP-RCT 125
TYPE OF WELDING	Socket
STANDARDS	EN ISO-15874 EN 13501 EN 671 EN 12845 DIN 8077 DIN 8078 RP 001.72 RP 001.84
COMPATIBLE SYSTEMS	RED FIRE

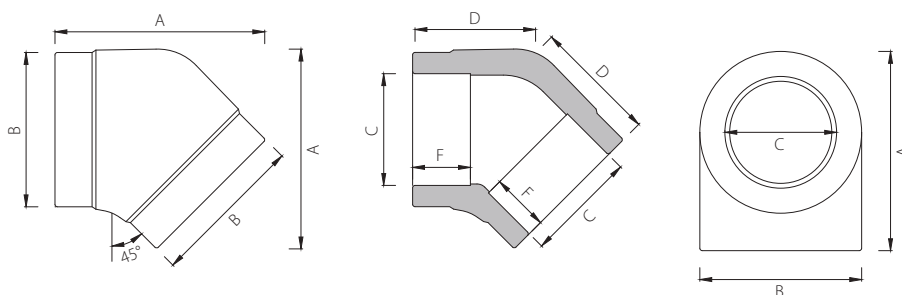

REFERENCE	DIAMETER	A	B	C min	D	F	WEIGHT	BAG	BOX
							(kg)	(un)	
P-CT202020-RF	20	48	27	19,2	26	15	0,013	50	400
P-CT202025-RF	25	55	35	24,2	29	16	0,019	25	250
P-CT202032-RF	32	67	42	31,1	36	18	0,036	10	120
P-202040-RF	40	70	52	39	40	21	0,057	5	80
P-202050-RF	50	85	65	48,9	44	24	0,092	4	40
P-202063-RF	63	97	82	61,9	53	28	0,172	2	20
P-202075-RF	75	130	101	73,7	68	31	0,328	2	12
P-202090-RF	90	150	122	88,6	79	37	0,529	1	6
P-2020110-RF	110	179	144	108,4	92	42	0,841	1	4
P-2020125-RF	125	209	162	122,4	110	40	1,380	1	4

ELBOW 90°



CHARACTERISTICS

COLOUR	Red
RAW MATERIAL	PP-R 100 PP-RCT 125
TYPE OF WELDING	Socket
STANDARDS	EN ISO-15874 EN 13501 EN 671 EN 12845 DIN 8077 DIN 8078 RP 001.72 RP 001.84
COMPATIBLE SYSTEMS	RED FIRE

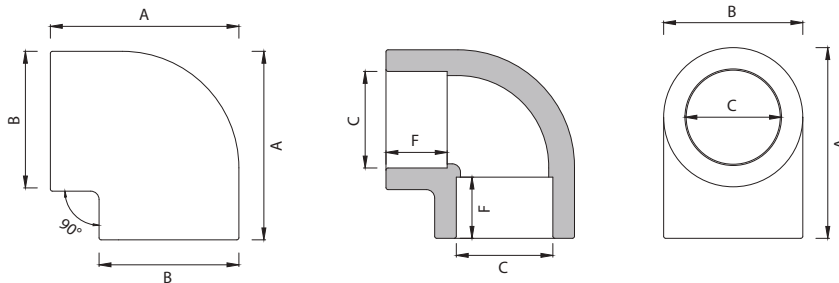

REFERENCE	DIAMETER	A	B	C min	F	WEIGHT	BAG	BOX
		(mm)				(kg)	(un)	
P-CT206020-RF	20	39,1	27,2	19,2	15	0,014	40	320
P-CT206025-RF	25	44,9	32,8	24,2	16	0,023	20	200
P-CT206032-RF	32	57,3	42,6	31,1	18	0,044	10	100
P-206040-RF	40	68,0	53,0	39,0	21	0,075	5	50
P-206050-RF	50	84,0	68,0	48,9	24	0,131	4	32
P-206063-RF	63	104,0	85,0	61,9	28	0,271	2	16
P-206075-RF	75	120,0	100,0	73,7	30	0,432	1	11
P-206090-RF	90	145,0	121,0	88,6	33	0,732	1	6
P-2060110-RF	110	168,0	131,0	108,4	37	1,143	1	4
P-2060125-RF	125	191,0	155,0	122,4	40	1,734	1	2

FEMALE ELBOW



CHARACTERISTICS

COLOUR	Red
RAW MATERIAL	PP-RCT 125 Brass CW617N
TYPE OF WELDING	Socket
STANDARDS	EN ISO-15874 EN 13501 EN 671 EN 12845 DIN 8077 DIN 8078 RP 001.72 RP 001.84
COMPATIBLE SYSTEMS	RED FIRE

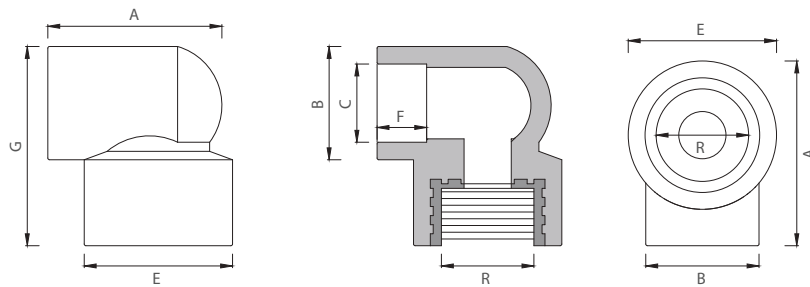

REFERENCE	DIAMETER (mm x in)	A	B	C max	E	F	G	R	WEIGHT (kg)	BAG (un)	BOX
		(mm)						(in)	(kg)	(un)	
P-CT208020-RF	20x1/2"	45	27	19,5	35	15	45	1/2"	0,045	20	200
P-CT208026-RF	25x1/2"	45	33	24,5	35	16	47	1/2"	0,049	10	100
P-CT208025-RF	25x3/4"	52	33	24,5	41	16	49	3/4"	0,059	10	100
P-CT208033-RF	32x3/4"	57	41	31,5	42	18	60	3/4"	0,076	5	50
P-CT208032-RF	32x1"	60	41	31,5	52	18	63	1"	0,111	5	50

MALE ELBOW



CHARACTERISTICS

COLOUR	Red
RAW MATERIAL	PP-RCT 125 Brass CW617N
TYPE OF WELDING	Socket
STANDARDS	EN ISO-15874 EN 13501 EN 671 EN 12845 DIN 8077 DIN 8078 RP 001.72 RP 001.84
COMPATIBLE SYSTEMS	RED FIRE

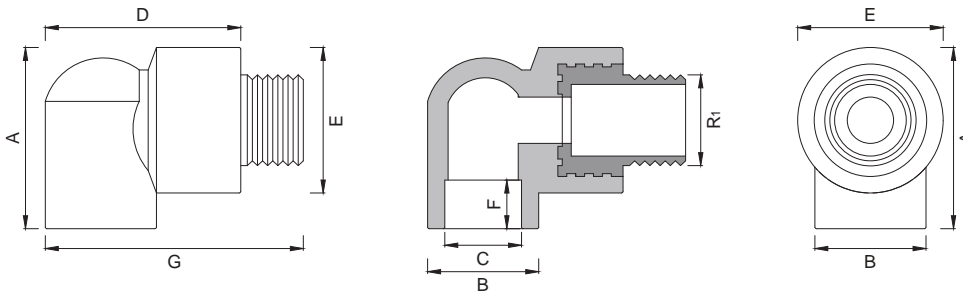

REFERENCE	DIAMETER	A	B	C _{max}	D	E	F	G	R ₁	WEIGHT	BAG	BOX
	(mm x in)				(mm)				(in)	(kg)	(un)	
P-CT209020-RF	20x1/2"	45	27	19,5	44	35	15	56	1/2"	0,054	20	140
P-CT209026-RF	25x1/2"	45	33	24,5	47	35	16	59	1/2"	0,082	10	100
P-CT209025-RF	25x3/4"	50	33	24,5	52	41	16	67	3/4"	0,046	10	100
P-CT209033-RF	32x3/4"	57	42	31,5	60	42	18	74	3/4"	0,098	5	50
P-CT209032-RF	32x1"	60	43	31,5	63	52	18	78	1"	0,129	5	50

LOOSE NUT ELBOW



CHARACTERISTICS

COLOUR	Red
RAW MATERIAL	PP-RCT 125 Brass CW617N
TYPE OF WELDING	Socket
STANDARDS	EN ISO-15874 EN 13501 EN 671 EN 12845 DIN 8077 DIN 8078 RP 001.72 RP 001.84
COMPATIBLE SYSTEMS	RED FIRE

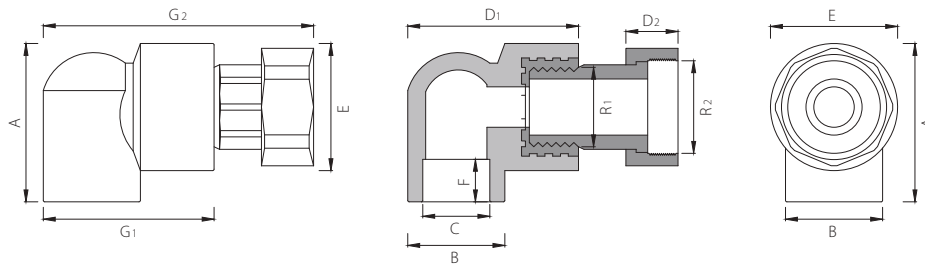

REFERENCE	DIAMETER	A	B	C max	D ₁	D ₂	E	F	G ₁	G ₂	R ₁	R ₂	WEIGHT	BAG	BOX
	(mm x in)				(mm)							(in)	(kg)	(un)	
P-CT208020-RFL	20x3/4"	45	27	19,5	45	14	35	15	44	69	1/2"	3/4"	0,108	10	100
P-CT208026-RFL	25x3/4"	45	33	24,5	47	14	35	16	53	90	1/2"	3/4"	0,112	10	75
P-CT208025-RFL	25x1"	52	33	24,5	49	16	41	16	51	79	3/4"	1"	0,161	10	75
P-CT208033-RFL	32x1"	57	41	31,5	63	16	42	18	66	98	3/4"	1"	0,178	5	50
P-CT208032-RFL	32x1 1/4"	60	41	31,5	60	19	52	18	66	95	1"	1 1/4"	0,276	5	50

TEE



CHARACTERISTICS

COLOUR	Red
RAW MATERIAL	PP-R 100 PP-RCT 125
TYPE OF WELDING	Socket
STANDARDS	EN ISO-15874 EN 13501 EN 671 EN 12845 DIN 8077 DIN 8078 RP 001.72 RP 001.84
COMPATIBLE SYSTEMS	RED FIRE

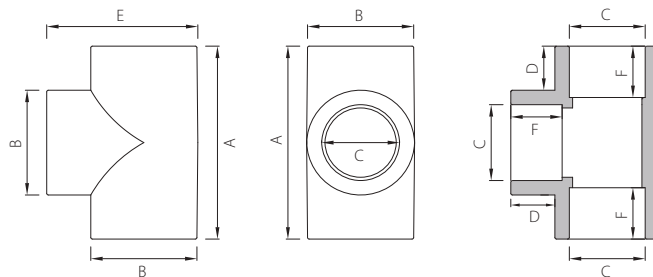

REFERENCE	DIAMETER	A	B	C min	D	E	F	WEIGHT	BAG	BOX
								(kg)	(un)	
								(mm)		
P-CT230020-RF	20	51	27	19,2	12	39	15	0,018	25	250
P-CT230025-RF	25	60	33	24,2	14	46	16	0,028	15	150
P-CT230032-RF	32	73	43	31,1	16	43	18	0,056	10	80
P-230040-RF	40	83	53	39,0	18	76	21	0,100	5	50
P-230050-RF	50	100	66	48,9	19	98	24	0,178	2	30
P-230063-RF	63	124	85	61,9	19	103	28	0,351	2	12
P-230075-RF	75	141	101	73,7	21	129	31	0,558	1	9
P-230090-RF	90	165	120	88,6	23	145	37	0,882	1	6
P-2300110-RF	110	201	140	108,4	28	169	42	1,534	1	4
P-2300125-RF	125	223	163	122,4	30	180	40	2,202	1	2

REDUCED TEE



CHARACTERISTICS

COLOUR	Red
RAW MATERIAL	PP-R 100 PP-RCT 125
TYPE OF WELDING	Socket
STANDARDS	EN ISO-15874 EN 13501 EN 671 EN 12845 DIN 8077 DIN 8078 RP 001.72 RP 001.84
COMPATIBLE SYSTEMS	RED FIRE

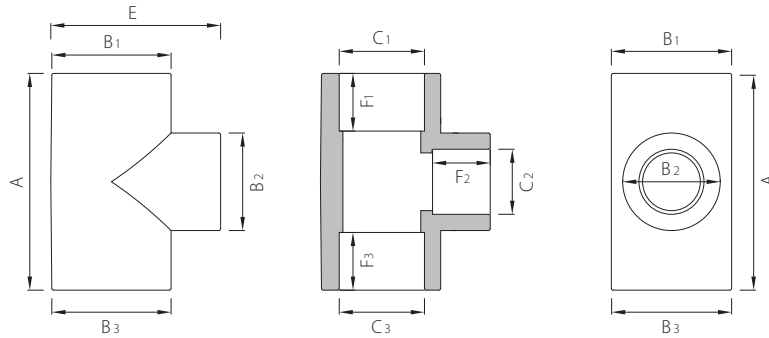

REFERENCE	DIAMETER	A	B ₁	B ₂	B ₃	C ₁	C ₂	C ₃	F ₁	F ₂	F ₃	E	WEIGHT	BAG	BOX
		(mm)											(kg)	(un)	
P-CT231020-RF	25x20x20	53	33	24	14	27	19	12	16	15	15	44	0,022	20	140
P-CT231025-RF	25x20x25	54	33	24	14	27	19	12	16	16	15	45	0,025	20	140
P-CT231023-RF	25x25x20	56	33	24	13	33	24	14	16	15	16	46	0,024	20	140
P-231032-RF	32x20x32	60	43	31	15	29	19	11	18	15	18	55	0,046	10	80
P-231035-RF	32x25x25	64	42	31	15	35	24	12	18	16	18	54	0,045	10	80
P-CT231033-RF	32x25x32	64	42	31	15	34	24	12	18	16	16	54	0,047	10	80
P-231041-RF	40x20x40	61	54	39	16	29	19	10	21	15	21	64	0,063	5	50
P-231042-RF	40x25x40	65	54	39	15	34	24	10	21	16	21	64	0,070	5	50
P-231043-RF	40x32x40	77	54	39	17	43	31	13	21	18	21	67	0,086	5	50
P-231052-RF	50x25x50	70	67	49	18	34	24	10	24	16	24	76	0,109	4	32
P-231053-RF	50x32x50	80	67	49	19	42	31	11	24	18	24	76	0,127	4	32

CONTINUED >



CONTINUED >

REFERENCE	DIAMETER	A	B ₁	B ₂	B ₃	C ₁	C ₂	C ₃	F ₁	F ₂	F ₃	E	WEIGHT	BAG	BOX
		(mm)											(kg)	(un)	
P-231054-RF	50x40x50	91	67	49	19	54	39	14	24	21	24	81	0,147	4	32
P-231062-RF	63x25x63	83	85	62	24	34	24	10	28	16	28	94	0,194	2	12
P-231063-RF	63x32x63	92	85	62	25	43	31	10	28	18	28	94	0,220	2	12
P-231064-RF	63x40x63	98	84	62	21	54	39	10	28	21	28	94	0,235	2	12
P-231065-RF	63x50x63	111	85	62	23	67	49	15	28	24	28	111	0,291	2	12
P-231074-RF	75x40x75	107	101	74	27	54	39	10	31	21	31	109	0,365	1	8
P-231075-RF	75x50x75	117	101	74	25	67	49	12	31	24	31	111	0,403	1	8
P-231076-RF	75x63x75	131	101	74	23	86	62	17	31	28	31	117	0,481	1	8
P-231097-RF	90x75x90	155	120	89	27	102	74	18	37	31	37	138	0,763	1	4
P-2310110-RF	110x90x110	182	144	108	31	121	89	23	42	37	42	166	1,218	1	2
P-2310125-RF	125x110x125	222	163	122	30	162	108	30	40	42	40	193	2,317	1	1

FEMALE TEE



CHARACTERISTICS

COLOUR	Red
RAW MATERIAL	PP-RCT 125 Brass CW617N
TYPE OF WELDING	Socket
STANDARDS	EN ISO-15874 EN 13501 EN 671 EN 12845 DIN 8077 DIN 8078 RP 001.72 RP 001.84
COMPATIBLE SYSTEMS	RED FIRE

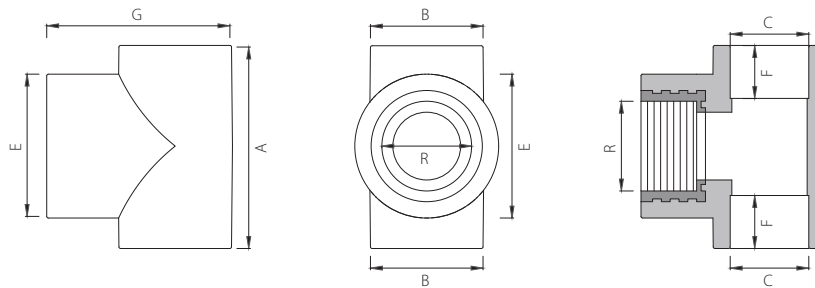

REFERENCE	DIAMETER (mm x in)	A	B	C max	E	F	G	R	WEIGHT (kg)	BAG (un)	BOX
P-CT232020-RF	20x1/2"	55	27	19,5	34	15	44	1/2"	0,049	20	160
P-CT232026-RF	25x1/2"	57	33	24,5	35	16	47	1/2"	0,053	10	100
P-CT232025-RF	25x3/4"	58	33	24,5	41	16	52	3/4"	0,065	10	100
P-CT232033-RF	32x3/4"	69	42	31,5	42	18	60	3/4"	0,082	5	50
P-CT232032-RF	32x1"	69	44	31,5	52	18	63	1"	0,112	5	50

MALE TEE



CHARACTERISTICS

COLOUR	Red
RAW MATERIAL	PP-RCT 125 Brass CW617N
TYPE OF WELDING	Socket
STANDARDS	EN ISO-15874 EN 13501 EN 671 EN 12845 DIN 8077 DIN 8078 RP 001.72 RP 001.84
COMPATIBLE SYSTEMS	RED FIRE

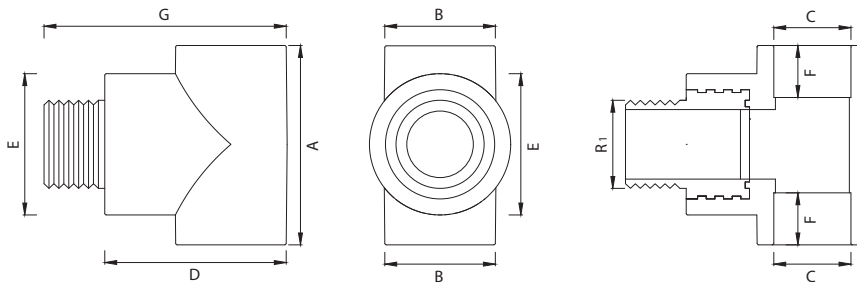

REFERENCE	DIAMETER	A	B	C _{max}	D	E	F	G	R ₁	WEIGHT	BAG	BOX
	(mm x in)				(mm)				(in)	(kg)		(un)
P-CT233020-RF	20x1/2"	55	27	19,5	44	35	15	56	1/2"	0,058	10	100
P-CT233026-RF	25x1/2"	57	33	24,5	47	35	16	59	1/2"	0,063	10	100
P-CT233025-RF	25x3/4"	58	33	24,5	52	42	16	67	3/4"	0,086	10	100
P-CT233033-RF	32x3/4"	69	42	31,5	60	42	16	59	3/4"	0,104	10	100
P-CT233032-RF	32x1"	69	44	31,5	63	52	18	77	1"	0,132	5	50

UNION



CHARACTERISTICS

COLOUR	Red
RAW MATERIAL	PP-R 100 PP-RCT 125
TYPE OF WELDING	Socket
STANDARDS	EN ISO-15874 EN 13501 EN 671 EN 12845 DIN 8077 DIN 8078 RP 001.72 RP 001.84
COMPATIBLE SYSTEMS	RED FIRE

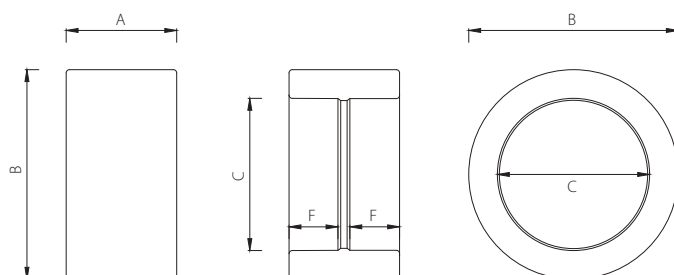

REFERENCE	DIAMETER	A	B	C min	F	WEIGHT	BAG	BOX
		(mm)					(kg)	(un)
P-CT200020-RF	20	31	27	19,2	15	0,090	50	500
P-CT200025-RF	25	34	33	24,2	16	0,014	40	320
P-CT200032-RF	32	39	42	31,1	18	0,025	20	200
P-200040-RF	40	43	54	39,0	21	0,046	10	100
P-200050-RF	50	49	66	48,9	24	0,077	5	60
P-200063-RF	63	58	85	61,9	28	0,142	4	32
P-200075-RF	75	65	101	73,7	31	0,223	2	24
P-200090-RF	90	75	120	88,6	37	0,350	1	13
P-2000110-RF	110	88	144	108,4	42	0,561	1	10
P-2000125-RF	125	90	162	122,4	40	0,702	1	6

REDUCER UNION



CHARACTERISTICS

COLOUR	Red
RAW MATERIAL	PP-R 100 PP-RCT 125
TYPE OF WELDING	≤ 125 - welding male/female
STANDARDS	EN ISO-15874 EN 13501 EN 671 EN 12845 DIN 8077 DIN 8078 RP 001.72 RP 001.84
COMPATIBLE SYSTEMS	RED FIRE

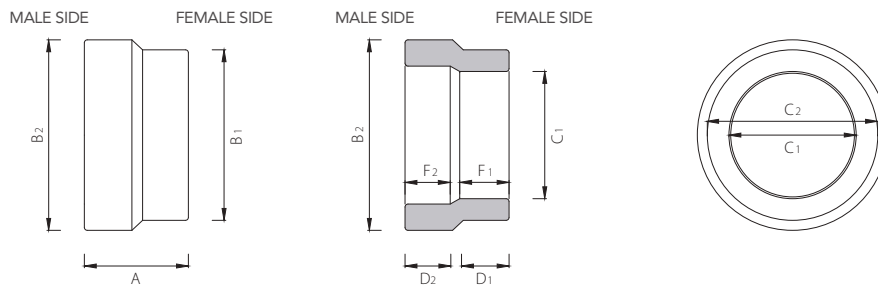

REFERENCE	DIAMETER	A	MALE SIDE				FEMALE SIDE				WEIGHT	BAG	BOX
			B ₂	C ₂	D ₂	F ₂	B ₁	C ₁	D ₁	F ₁			
(mm)											(kg)	(un)	
P-CT238025-RF	25x20	34	25	17	16	19	27	19	16	15	0,011	50	100
P-CT238032-RF	32x20	37	32	24	19	16	28	19	17	15	0,016	30	100
P-CT238033-RF	32x25	34	32	24	21	18	32	24	13	16	0,014	30	100
P-238040-RF	40x20	41	40	27	22	23	29	19	15	15	0,030	20	100
P-238041-RF	40x25	43	40	29	20	20	34	24	17	16	0,028	20	100
P-238042-RF	40x32	47	40	29	29	21	42	31	18	18	0,035	20	100
P-238051-RF	50x20	45	50	37	23	18	28	19	15	15	0,035	10	100
P-238055-RF	50x25	47	50	37	23	19	34	24	16	16	0,036	10	100
P-238052-RF	50x32	54	51	36	24	26	42	32	20	18	0,051	10	100
P-238050-RF	50x40	52	51	37	31	24	52	39	20	21	0,053	10	100

CONTINUED >



CONTINUED >

REFERENCE	DIAMETER	A	FEMALE SIDE				MALE SIDE				WEIGHT (kg)	BAG (un)	BOX		
			B ₁	C ₁	D ₁	F ₁	B ₂	C ₂	D ₂	F ₂					
													(mm)	(kg)	(un)
P-238062-RF	63x25	53	64	44	22	23	34	24	19	16	0,058	5	100		
P-238065-RF	63x32	50	64	47	27	21	42	31	18	18	0,058	5	100		
P-238063-RF	63x40	48	64	47	25	20	53	39	18	21	0,059	5	100		
P-238067-RF	63x50	53	64	43	29	28	66	49	24	24	0,089	5	100		
P-238075-RF	75x50	60	76	55	31	24	66	49	24	24	0,107	4	100		
P-238076-RF	75x63	70	76	50	34	32	84	62	28	28	0,172	4	100		
P-238096-RF	90x63	66	91	65	35	27	83	62	28	28	0,171	2	100		
P-238097-RF	90x75	80	91	64	37	34	99	73	30	31	0,251	2	100		
P-2380116-RF	110x63	72	110	80	42	28	83	62	27	28	0,271	1	100		
P-2380117-RF	110x75	77	110	80	42	30	98	74	31	31	0,284	1	100		
P-2380110-RF	110x90	93	110	75	44	38	118	88	35	33	0,417	1	100		
P-2380125-RF	125x110	114	125	85	62	72	141	109	47	37	0,745	1	100		

FEMALE UNION



CHARACTERISTICS

COLOUR	Red
RAW MATERIAL	PP-R 100 PP-RCT 125 Brass CW617N
TYPE OF WELDING	Socket
STANDARDS	EN ISO-15874 EN 13501 EN 671 EN 12845 DIN 8077 DIN 8078 RP 001.72 RP 001.84
COMPATIBLE SYSTEMS	RED FIRE

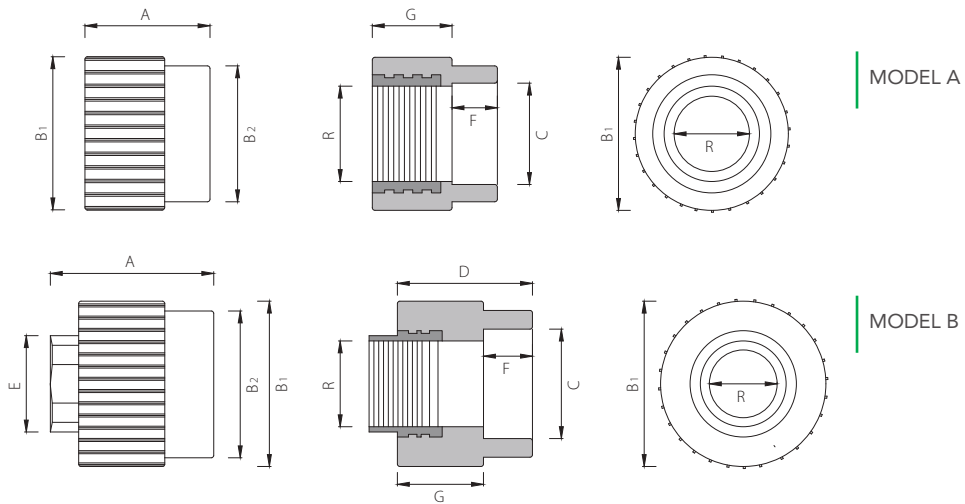

REFERENCE	DIAMETER	A	B ₁	B ₂	C min	D	E	F	G	R	WEIGHT	MODEL	BAG	BOX
	(mm x in)	(mm)									(in)	(kg)		(un)
P-CT234020-RF	20x1/2"	35	33	27	19,2	-	-	15	21	1/2"	0,038	A	20	200
P-CT234026-RF	25x1/2"	35	36	33	24,2	-	-	16	21	1/2"	0,041	A	10	150
P-CT234025-RF	25x3/4"	39	40	33	24,2	-	-	16	21	3/4"	0,049	A	10	150
P-CT234033-RF	32x3/4"	41	42	43	31,1	-	-	19	26	3/4"	0,054	A	10	100
P-CT234032-RF	32x1"	47	53	43	31,1	-	-	19	26	1"	0,088	A	10	100
P-234040-RF	40x1 1/4"	57	68	54	39,0	48	48	21	28	1 1/4"	0,251	B	5	50
P-234050-RF	50x1 1/2"	62	80	66	48,9	53	54	24	32	1 1/2"	0,378	B	4	36
P-234063-RF	63x2"	76	94	84	61,9	60	65	28	32	2"	0,569	B	2	20
P-234075-RF	75x2 1/2"	85	114	100	73,7	63	81	31	32	2 1/2"	0,945	B	1	15
P-234090-RF	90x3"	92	128	119	88,6	71	94	33	34	3"	1,241	B	1	16
P-2340110-RF	110x4"	104	164	144	108,4	83	119	37	41	4"	2,011	B	1	6

MALE UNION



CHARACTERISTICS

COLOUR	Red
RAW MATERIAL	PP-R 100 PP-RCT 125 Brass CW617N
TYPE OF WELDING	Socket
STANDARDS	EN ISO-15874 EN 13501 EN 671 EN 12845 DIN 8077 DIN 8078 RP 001.72 RP 001.84
COMPATIBLE SYSTEMS	RED FIRE

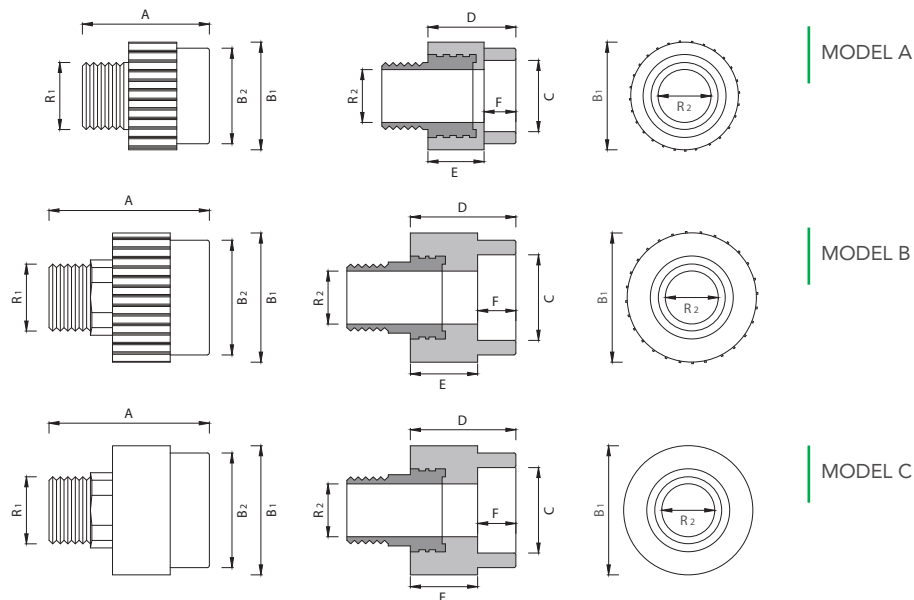

REFERENCE	DIAMETER	A	B ₁	B ₂	C min	D	E	F	R ₁	R ₂	WEIGHT	MODEL	BAG	BOX
	(mm x in)				(mm)				(in)	(mm)	(kg)			(un)
P-CT325020-RF	20x1/2"	47	33	27	19,2	33	15	21	1/2"	16	0,047	A	20	200
P-CT325026-RF	25x1/2"	48	36	33	24,2	34	16	21	1/2"	16	0,051	A	10	150
P-CT325025-RF	25x3/4"	53	40	33	24,2	36	16	21	3/4"	20	0,071	A	10	150
P-CT325033-RF	32x3/4"	55	42	43	31,1	39	18	26	3/4"	20	0,076	A	10	100
P-CT325032-RF	32x1"	61	51	43	31,1	41	18	26	1"	26	0,108	A	10	100
P-325040-RF	40x1 1/4"	77	68	54	39,0	48	21	28	1 1/4"	35	0,296	B	4	40
P-325050-RF	50x1 1/2"	90	79	66	48,9	54	24	32	1 1/2"	40	0,537	B	4	32
P-325063-RF	63x2"	98	95	84	61,9	60	28	32	2"	52	0,797	C	2	16
P-325075-RF	75x2 1/2"	109	112	100	73,7	64	31	32	2 1/2"	66	1,208	C	1	12
P-325090-RF	90x3"	121	127	119	88,6	67	37	34	3"	78	1,65	C	1	8
P-3250110-RF	110x4"	137	166	144	108,4	78	42	41	4"	103	2,529	C	1	3

LOOSE NUT UNION



CHARACTERISTICS

COLOUR	Red
RAW MATERIAL	PP-R 100 PP-RCT 125 Brass CW617N
TYPE OF WELDING	Socket
STANDARDS	EN ISO-15874 EN 13501 EN 671 EN 12845 DIN 8077 DIN 8078 RP 001.72 RP 001.84
COMPATIBLE SYSTEMS	RED FIRE

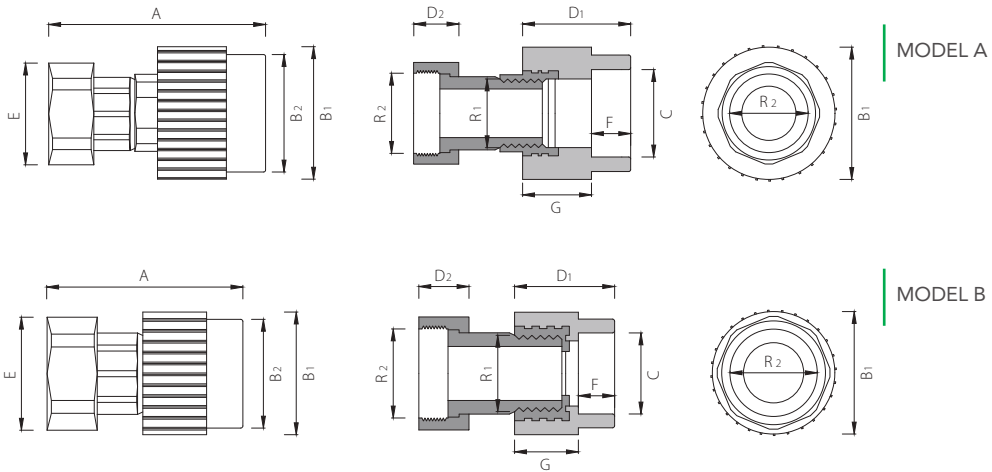

REFERENCE	DIAMETER	A	B ₁	B ₂	C _{min}	D ₁	D ₂	E	F	G	R ₁	R ₂	WEIGHT	MODEL	BAG	BOX
	(mm x in)	(mm)									(in)		(kg)		(un)	
P-CT234020-RFL	20x3/4"	67	33	27	19,2	35	13	32	15	21	1/2"	3/4"	0,113	A	10	100
P-CT234026-RFL	25x3/4"	67	36	33	24,2	35	13	32	16	21	1/2"	3/4"	0,115	A	10	100
P-CT234025-RFL	25x1"	72	40	33	24,2	39	16	41	16	21	3/4"	1"	0,211	A	10	100
P-CT234033-RFL	32x1"	81	53	43	31,1	47	16	51	19	26	3/4"	1"	0,210	A	5	60
P-CT234032-RFL	32x1 1/4"	81	42	43	31,1	41	17	51	19	26	1"	1 1/4"	0,389	A	5	60
P-234040-RFL	40X1 1/2"	94	68	54	39	57	18	58	21	28	1 1/4"	1 1/2"	0,253	B	3	30
P-234050-RFL	50x2"	107	80	66	48,9	62	22	71	24	32	1 1/2"	2"	1,013	B	2	24
P-234063-RFL	63x2 1/2"	123	94	84	61,9	76	26	89	28	32	2"	2 1/2"	1,241	B	1	12
P-234075-RFL	75x3"	135	114	100	73,7	85	28	101	31	32	2 1/2"	3"	2,456	B	1	9

BRASS FEMALE UNION



CHARACTERISTICS

COLOUR	Red
RAW MATERIAL	PP-R 100 Brass CW617N
TYPE OF WELDING	Socket
STANDARDS	EN ISO-15874 EN 13501 EN 671 EN 12845 DIN 8077 DIN 8078 RP 001.72 RP 001.84
COMPATIBLE SYSTEMS	RED FIRE

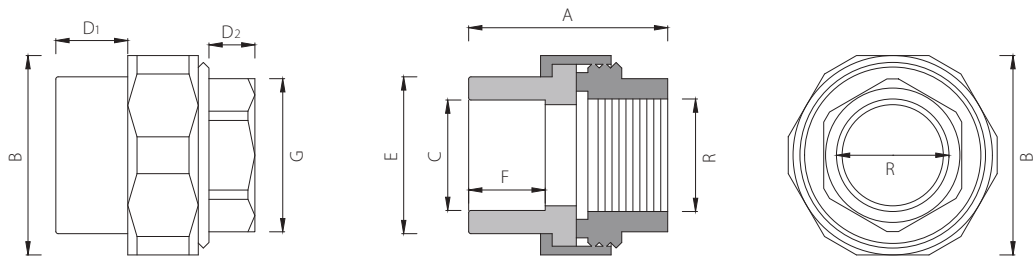

REFERENCE	DIAMETER (mm x in)	A	B	C max	D ₁	D ₂	E	F	G	R (in)	WEIGHT (kg)	BAG (un)	BOX (un)
P-200020-RFDH	20x1/2"	39	39	19,5	15	10	28	15	24	1/2"	0,095	10	80
P-200025-RFDH	25x3/4"	41	50	24,5	16	10	33	16	30	3/4"	0,119	10	60
P-200032-RFDH	32x1"	45	65	31,5	18	11	43	18	37	1"	0,194	5	30
P-200040-RFDH	40x1 1/4"	50	63	39,4	21	12	51	21	34	1 1/4"	0,229	2	16
P-200050-RFDH	50x1 1/2"	57	80	49,4	25	12	66	24	52	1 1/2"	0,975	2	12

BRASS MALE UNION



CHARACTERISTICS

COLOUR	Red
RAW MATERIAL	PP-R 100 Brass CW617N
TYPE OF WELDING	Socket
STANDARDS	EN ISO-15874 EN 13501 EN 671 EN 12845 DIN 8077 DIN 8078 RP 001.72 RP 001.84
COMPATIBLE SYSTEMS	RED FIRE

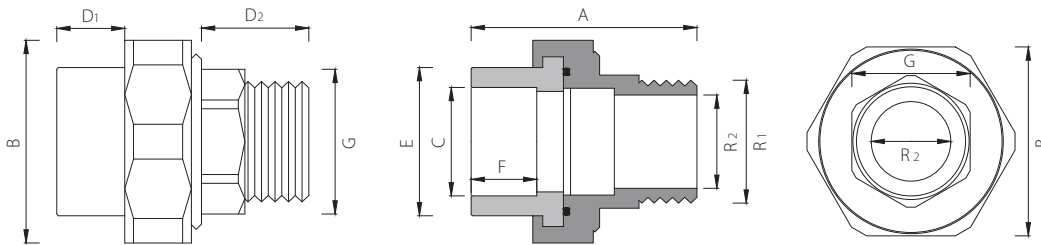

REFERENCE	DIAMETER	A	B	C _{max}	D ₁	D ₂	E	F	G	R	WEIGHT	BAG	BOX
	(mm x in)	(mm)								(in)	(kg)	(un)	
P-200020-RFDM	20x1/2"	50	39	19,5	15	21	28	15	22	1/2"	0,103	10	80
P-200025-RFDM	25x3/4"	51	45	24,5	16	21	33	16	37	3/4"	0,133	10	60
P-200032-RFDM	32x1"	58	55	31,5	18	23	43	18	34	1"	0,210	5	30
P-200040-RFDM	40x1 1/4"	62	63	39,4	20	23	51	21	42	1 1/4"	0,260	2	16
P-200050-RFDM	50x1 1/2"	71	80	49,4	24	25	66	24	31	1 1/2"	0,463	2	12

UNIVERSAL UNION



CHARACTERISTICS

COLOUR	Red
RAW MATERIAL	PP-R 100 Brass CW617N
TYPE OF WELDING	Socket
STANDARDS	EN ISO-15874 EN 13501 EN 671 EN 12845 DIN 8077 DIN 8078 RP 001.72 RP 001.84
COMPATIBLE SYSTEMS	RED FIRE

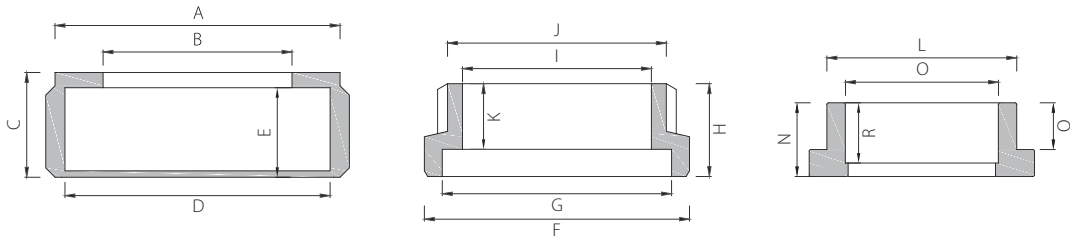

REFERENCE	DN	A	B	C	D	E	F	G	H	I	J	K	L	N	O _{min}	Q	R	WG	BAG	BOX		
																		(mm)		(kg)	(un)	
P-200020-RFD	20	43,0	28,5	15,8	15	13,8	11	2,0	13,5	2,3	M40x1,5	34,6	28	21,5	19,2	16,6	14,6	0,113	10	100		
P-200025-RFD	25	49,5	33,7	15,9	16	13,9	10,6	2,0	13,5	2,4	M46x1,5	39,8	33	23,2	24,2	18	16,1	0,145	10	70		
P-200032-RFD	32	61,0	43,6	17	19	15	12	2,0	14,4	2,6	M57x2,0	50,4	43	25,9	31,1	21,2	18,5	0,234	5	35		
P-200040-RFD	40	67,5	51,2	20,3	21	17,8	13,8	2,5	17,3	3,0	M63x2,0	56,5	51	29,5	39,0	22,9	20,5	0,307	2	24		
P-200050-RFD	50	84,0	66,6	24,5	24	22	16,7	2,5	21,5	3,0	M80x2,0	73	66	35,5	48,9	27	23,8	0,519	2	12		
200063-RFD	63	97,8	78,8	25,1	28	21,9	-	84,9	21	78,9	84,7	13,5	72	39,1	61,9	30,4	23,4	0,685	2	10		

WELD-IN SADDLE



CHARACTERISTICS

COLOUR	Red
RAW MATERIAL	PP-R 100
TYPE OF WELDING	Socket
STANDARDS	EN ISO-15874 EN 13501 EN 671 EN 12845 DIN 8077 DIN 8078 RP 001.72 RP 001.84
COMPATIBLE SYSTEMS	RED FIRE

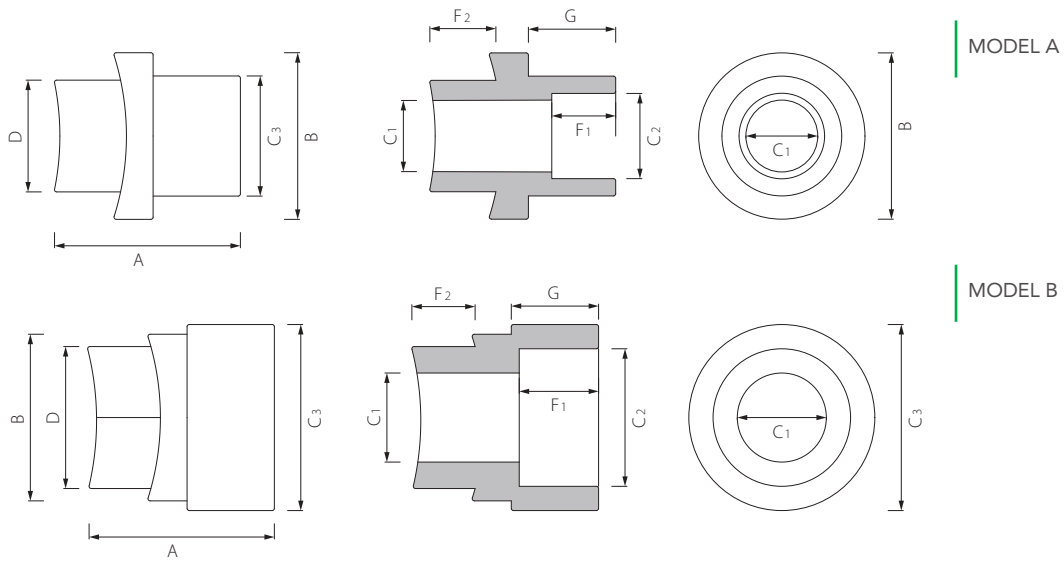

REFERENCE	DIAMETER	A	B	C ₁	C ₂ min	C ₃	D	F ₁	F ₂	G	WEIGHT	MODEL	BAG	BOX
	(mm)					(mm)					(kg)			(un)
P-480063-RF	63-75-90x20	38	38	16	19,2	27	25	15	10	22	0,018	A	50	400
P-480064-RF	63-75-90x25	38	38	16	24,2	33	25	16	10	22	0,019	A	40	320
P-480065-RF	63-75-90x32	46	38	20	31,1	42	32	18	11	28	0,032	B	20	200
P-480110-RF	110-125-160x20	42	38	16	19,2	27	25	15	14	22	0,019	A	50	400
P-480111-RF	110-125-160x25	42	38	16	24,2	33	25	16	14	22	0,020	B	40	320
P-480112-RF	110-125-160x32	50	38	20	31,1	42	32	18	14	28	0,033	B	20	200

Note: the necessary tools for the fusion of HELIROMA weld-in saddles are listed on pages 142 and 143.

WELD-IN SADDLE FEMALE



CHARACTERISTICS

COLOUR	Red
RAW MATERIAL	PP-R 100 Brass CW617N
TYPE OF WELDING	Socket
STANDARDS	EN ISO-15874 EN 13501 EN 671 EN 12845 DIN 8077 DIN 8078 RP 001.72 RP 001.84
COMPATIBLE SYSTEMS	RED FIRE

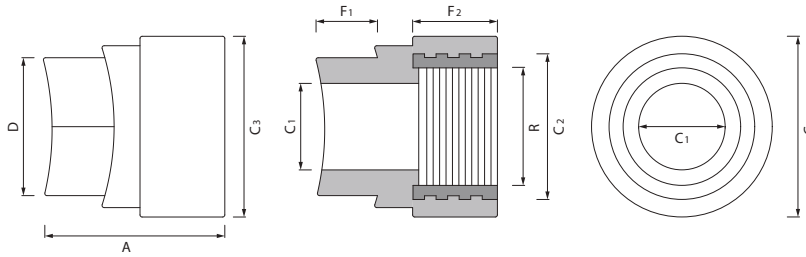

REFERENCE	DIAMETER	A	B	C ₁	C ₂	C ₃	D	F ₁	F ₂	R	WEIGHT	BAG	BOX
	(mm x in)	(mm)						(in)	(kg)	(un)			
P-490063-RF	63-75-90x1/2"	46	38	20	27	42	32	10	28	1/2"	0,060	20	200
P-490064-RF	63-75-90x3/4"	46	38	20	32	42	32	10	28	3/4"	0,061	20	200
P-490110-RF	110-125-160x1/2"	50	38	20	27	42	32	15	28	1/2"	0,063	20	200
P-490111-RF	110-125-160x3/4"	50	38	20	32	42	32	15	28	3/4"	0,062	20	200

Note: the necessary tools for the fusion of HELIROMA weld-in saddles are listed on pages 142 and 143.

WELD-IN SADDLE MALE



CHARACTERISTICS

COLOUR	Red
RAW MATERIAL	PP-R 100 Brass CW617N
TYPE OF WELDING	Socket
STANDARDS	EN ISO-15874 EN 13501 EN 671 EN 12845 DIN 8077 DIN 8078 RP 001.72 RP 001.84
COMPATIBLE SYSTEMS	RED FIRE

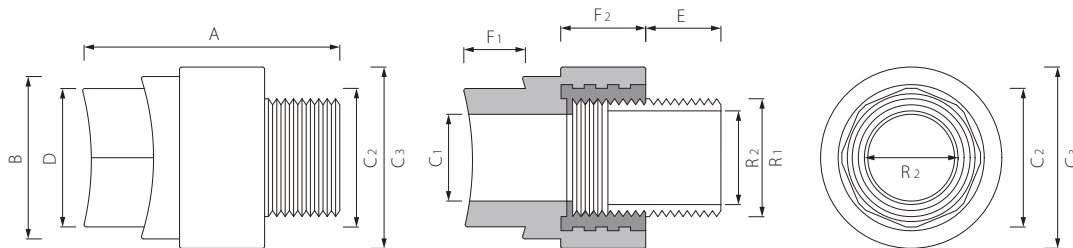

REFERENCE	DIAMETER	A	B	C ₁	C ₂	C ₃	D	E	F ₁	F ₂	R ₁	R ₂	WEIGHT	BAG	BOX
	(mm x in)			(mm)							(in)		(kg)	(un)	
P-500063-RF	63-75-90x1/2"	61	38	20	26	43	32	15	10	28	1/2"	16	0,071	20	200
P-500064-RF	63-75-90x3/4"	63	38	20	26	43	32	17	10	28	3/4"	21	0,082	20	200
P-500110-RF	110-125-160x1/2"	63	38	20	26	43	32	15	15	28	1/2"	16	0,073	20	200
P-500111-RF	110-125-160x3/4"	65	38	20	26	43	32	17	15	28	3/4"	21	0,083	20	200

Note: the necessary tools for the fusion of HELIROMA weld-in saddles are listed on pages 142 and 143.

DEMOUNTABLE VALVE



CHARACTERISTICS

COLOUR	Red
RAW MATERIAL	PP-R 100 Brass CW617N
TYPE OF WELDING	Socket
STANDARDS	EN ISO-15874 EN 13501 EN 671 EN 12845 DIN 8077 DIN 8078 RP 001.72 RP 001.84
COMPATIBLE SYSTEMS	RED FIRE

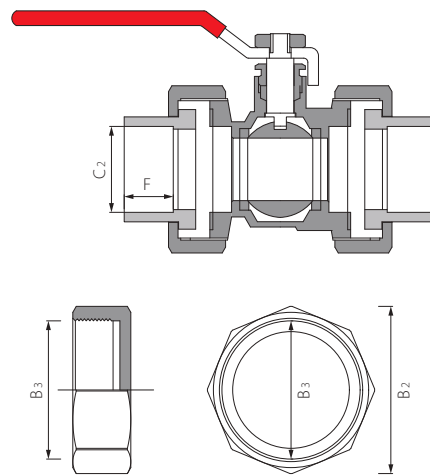
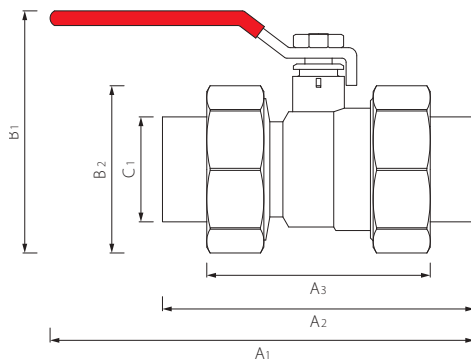

REFERENCE	DIAMETER	A ₁	A ₂	A ₃	B ₁	B ₂	B ₃	C ₁	C ₂	F	WEIGHT	BAG	BOX
		(mm)									(kg)	(un)	
P-244020-RFX	20	127	95	67	65	43	36	28	19	16	0,34	5	70
P-244025-RFX	25	142	96	68	72	49	42	33	24	17	0,465	5	50
P-244032-RFX	32	167	104	70	92	61	52	43	31	18	0,712	5	30
P-244040-RFX	40	192	121	82	111	73	68	50	39	20	1,116	2	20
P-244050-RFX	50	215	143	97	130	92	85	66	49	23	1,814	2	8

FEMALE FLANGE ADAPTOR



CHARACTERISTICS

COLOUR	Red
RAW MATERIAL	PP-R 100
TYPE OF WELDING	Socket
STANDARDS	EN ISO-15874 EN 13501 EN 671 EN 12845 DIN 8077 DIN 8078 RP 001.72 RP 001.84
COMPATIBLE SYSTEMS	RED FIRE

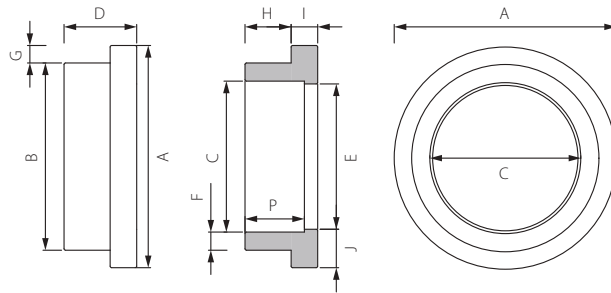

REFERENCE	DIAMETER	A	B	C	Tol. C	D	E	F	G	H	I	J	P	WEIGHT	BAG	BOX
(mm)														(kg)	(un)	
P-PBRIDA40H-RF	40	77	50	37	+0,4	26	38	7	13	16	10	20	21	0,028	25	100
P-PBRIDA50H-RF	50	87	64	49	+0,5	30	48	8	11	18	12	19	24	0,066	15	60
P-PBRIDA63H-RF	63	100	77	61	+0,6	34	60	9	11	20	14	20	28	0,090	10	30
P-PBRIDA75H-RF	75	113	94	73	+0,5	36	72	11	9	23	13	20	31	0,122	4	20
P-PBRIDA90H-RF	90	133	114	89	+1,5	42	88	13	9	26	16	22	33	0,200	4	20
P-PBRIDA110H-RF	110	159	134	106	+1,7	49	108	15	12	30	19	27	37	0,305	2	10
P-PBRIDA125H-RF	125	188	166	124	+2,2	52	124	21	11	32	20	32	40	0,521	1	10

STEEL FLANGE



CHARACTERISTICS

RAW MATERIAL Steel Flange ST 37.2, Zinc Coated

STANDARDS DIN EN1092 | ISO 15494:2015

COMPATIBLE SYSTEMS RED FIRE

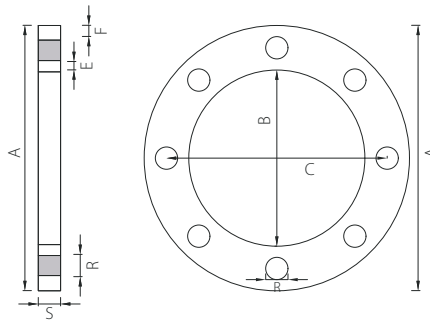

REFERENCE	DIAMETER	A	B	C	E	F	R	S	HOLES	WEIGHT	BAG
		(mm)							(un)	(kg)	(un)
BRIDA40	40	140	52	100	16	11	18	16	4	1,489	1
BRIDA50	50	150	65	110	14	11	18	15	4	1,620	1
BRIDA63	63	165	78	125	14	11	18	18	4	2,221	1
BRIDA75	75	185	95	145	16	12	18	18	4	2,653	1
BRIDA90	90	200	115	160	14	11	18	20	8	2,940	1
BRIDA110	110	220	135	180	13	12	18	21	8	3,440	1

COATED STEEL FLANGE



CHARACTERISTICS

RAW MATERIAL Carbon Steel Flange ST 37.2, coated with
Fiberglass reinforced Polypropylene

STANDARDS DIN EN1092 | ISO 15494:2015

COMPATIBLE SYSTEMS RED FIRE

MODEL A

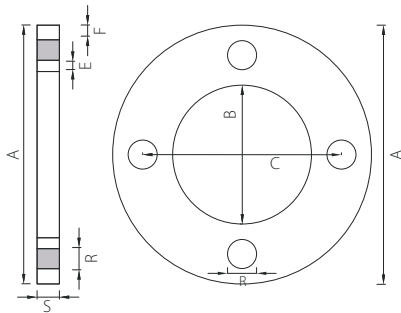

MODEL B

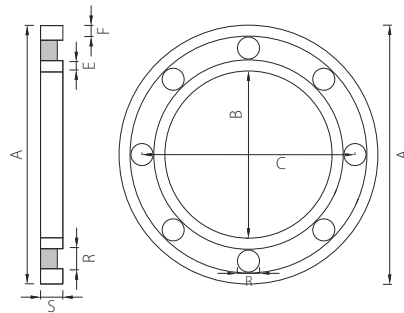

REFERENCE	DIAMETER	A	B	C	E	F	G	H	R	S	HOLES	WEIGHT	MODEL	BAG	
		(mm)										(un)	(kg)		(un)
BRIDA40-REV	40	142	53	100	15	12	-	-	18	18	4	0,671	A	1	
BRIDA50-REV	50	152	66	110	13	12	-	-	18	18	4	0,767	A/B	1	
BRIDA63-REV	63	172	78	125	15	15	21	7	18	20	4	1,058	A/B	1	
BRIDA75-REV	75	189	95	145	16	13	-	-	18	22	4	1,222	A/B	1	
BRIDA90-REV	90	200	115	160	14	11	20	7	18	20	8	1,100	A/B	1	
BRIDA110-REV	110	223	135	179	13	13	-	-	18	20	8	1,442	A/B	1	
BRIDA125-REV	125	250	168	209	12	12	-	-	18	24	8	2,192	A/B	1	

END CAP



CHARACTERISTICS

COLOUR	Red
RAW MATERIAL	PP-R 100
TYPE OF WELDING	Socket
STANDARDS	EN ISO-15874 EN 13501 EN 671 EN 12845 DIN 8077 DIN 8078 RP 001.72 RP 001.84
COMPATIBLE SYSTEMS	RED FIRE

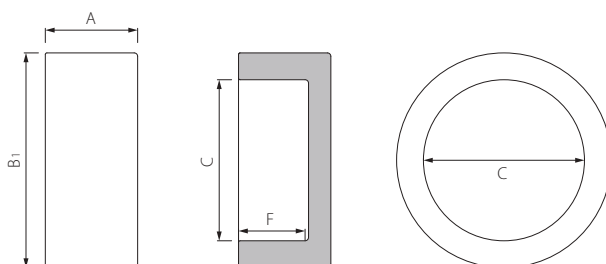

REFERENCE	DIAMETER	A	B ₁	C _{min}	F	WEIGHT	BAG	BOX
		(mm)				(kg)	(un)	
P-242020-RF	20	20	28	19,2	15	0,013	50	500
P-242025-RF	25	22	34	24,2	16	0,017	50	500
P-242032-RF	32	26	42	31,1	18	0,023	30	240
P-242040-RF	40	29	53	39,0	21	0,036	20	200
P-242050-RF	50	32	68	48,9	24	0,065	10	100
P-242063-RF	63	42	87	61,9	28	0,15	5	50
P-242075-RF	75	43	100	73,7	30	0,186	2	40
P-242090-RF	90	53	122	88,6	33	0,346	1	24
P-2420110-RF	110	61	144	108,4	37	0,504	1	10
P-2420125-RF	125	68	162	122,4	40	0,702	1	10

BRIDGE



CHARACTERISTICS

COLOUR	Red
RAW MATERIAL	PP-R 100
TYPE OF WELDING	Socket
STANDARDS	EN ISO-15874 EN 13501 EN 671 EN 12845 DIN 8077 DIN 8078 RP 001.72 RP 001.84
COMPATIBLE SYSTEMS	RED FIRE

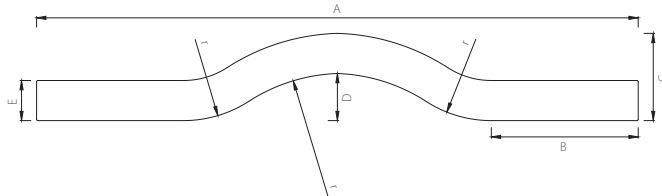

REFERENCE	DIAMETER	A	B	C	D	E	R	WEIGHT	BAG	BOX
		(mm)						(kg)	(un)	
P-UC20-RF	20	300	80	42	22	20	61,2	0,065	10	100
P-UC25-RF	25	330	75	52	27	25	81,8	0,098	10	60
P-UC32-RF	32	380	80	64	34	32	97,5	0,16	5	40



MULTILAYER

3

MULTILAYER SYSTEM

- PE-RT / AL / PE-RT | KLIMAPRESS PPSU | KLIMAPRESS |
FLANGED FITTINGS

INSTALLATION GUIDELINES

ASSEMBLY TECHNIQUES

SYSTEM FEATURES

SYSTEM GENERAL ADVANTAGES

CERTIFICATIONS

PRODUCT RANGE

- Multilayer Pipe
- PPSU Fittings
- Klimapress and Flanged Fittings
- Multilayer Tools

MULTILAYER SYSTEM

PE-RT / AL / PE-RT | KLIMAPRESS PPSU | KLIMAPRESS | FLANGED FITTINGS



CHARACTERISTICS



APPROVED FOR DRINKING WATER



HEATING SYSTEMS



DISINFECTION RESISTANT



ANTIMICROBIAL



LEGIONELLA CONTROL



100% RECYCLABLE



ECO-FRIENDLY

PIPE CLASSIFICATION

SDR Standard dimension ratio – ratio between pipe's outside diameter and its wall thickness

$$SDR = \frac{d_e}{e}$$

S Series - dimensionless index, which is used for the calculation of the wall thickness of the pipe

$$S = \frac{d_e - e}{2e}$$

d_e Outside diameter of the pipe

e Wall thickness of the pipe

MATERIAL

PE-RT /AL /PE-RT Polyethylene of Raised Temperature Type II/
Aluminium /
Polyethylene of Raised Temperature Type II

PPSU Polyphenylsulfone

PRODUCT RANGE OVERVIEW

● HELIKLIMA
Multilayer
PE-RT / AL / PE-RT
Ø16 - Ø110
○

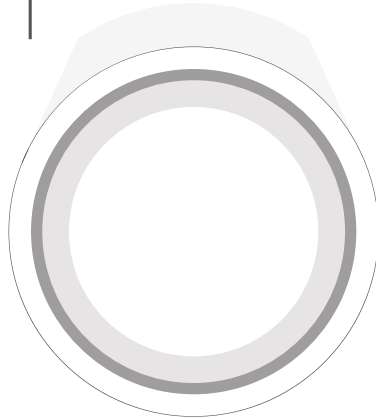

MULTILAYER PIPE AND FITTINGS											
DIAMETERS (mm)	16	18	20	25	32	40	50	63	75	90	110
HELIKLIMA PE-RT / AL / PE-RT PIPE	✓	✓	✓	✓	✓	✓	✓	✓	✓	✓	✓
KLIMAPRESS PPSU FITTINGS	✓	✓	✓	✓	✓						
KLIMAPRESS BRASS FITTINGS	✓	✓	✓	✓	✓	✓	✓	✓	✓		
FLANGED FITTINGS									✓	✓	✓

Fittings ø 16 - 75 mm → Press Fitting U
 Fittings ø 75 - 110 mm → Flanged Fittings
 Pipes ø 16 - 32 mm → Supplied in Coils
 Pipes ø 16 - 110 mm → Supplied in Bars



MULTILAYER SYSTEM

MULTILAYER PIPE - HELIKLIMA

HELIROMA HELIKLIMA multilayer pipes cross-links the best qualities of both metal and plastic pipes in one single system. The pipe structure is built on a 5 layer structure where the internal and external layers are made of PE-RT type II and the middle layer is made of aluminium, being all layers connected by a special bonding agent.

The aluminum laser edge-welded technique guarantees maximum safety. The aluminum thickness used in HELIROMA pipes complies with the compressive strength requirements as well as bending capability. The aluminum layer provides a 100% oxygen free barrier and low linear thermal expansion similar to metal pipes. The pipe internal wall surface is extremely smooth, avoiding corrosion phenomena, limescale or deposits.

HELIKLIMA is a composite pipe very easy to deploy and can be used in different kind of installations. HELIROMA multilayer system is the perfect solution for drinking water distribution, heating/colling applications, HVAC systems and compressed air systems even in larger residential industrial and commercial properties.





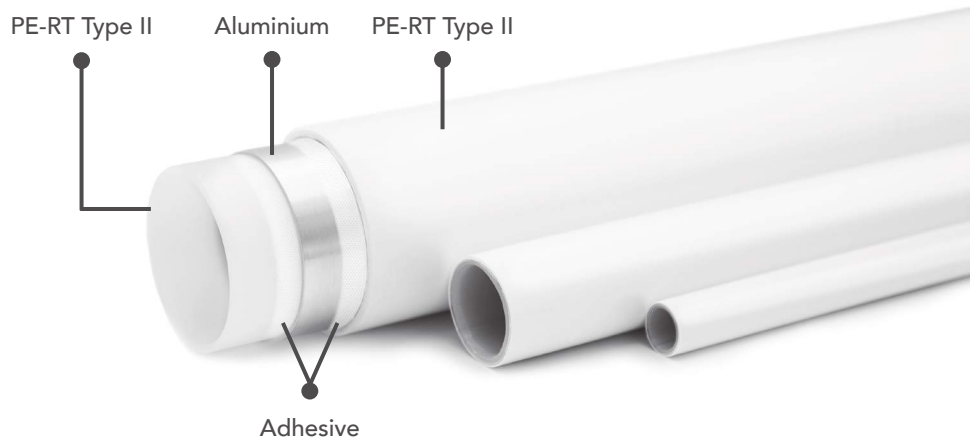













HELIROMA HELIKLIMA system is reliable, long-lasting, easy to install and cost effective.

HELIROMA offers a range of dimensions from 16 mm up to 110 mm.



PE-RT / AL / PE-RT PROPERTIES		
PARAMETER	VALUE	STANDARD
PHYSICAL		
Density	941 kg/m ³	ISO 1183
MFI 190°C/5,00 kg	1,9 g/10min	ISO 1133
Roughness	0,007 mm	ISO 5436
MECHANICAL		
Tensile Modulus	645 MPa	ISO 527
Pipe Constant	30	
Burst Pressure	80 bar	
Maximum Laying Temperature	50°C	
Minimum Laying Temperature	-10°C	
THERMAL		
Vicat Softening Temperature	125°C	ISO 178
Thermal Expansion Coefficient 20-100°C	0,026 mm/m.K	VDE 0304
Thermal Conductivity at 20°C	0,43 W/m.K	DIN 52612
Fire Classification	B2	DIN 4102
OTR	0 cm ³ /cm ² .day	

ADVANTAGES AND KEY FEATURES OF MULTILAYER

-  LIGHTWEIGHT, FLEXIBLE, EASY HANDLING
-  EXCELLENT HYDROSTATIC STRESS PERFORMANCE
-  WIDE DIMENSIONAL RANGE
-  LASER EDGE-WELDED ALUMINIUM
-  LONG LIFE EXPECTANCY
-  LOW LINEAR EXPANSION
-  FEWER SUPPORTS NEEDED
-  CORROSION RESISTANT
-  HIGH CHEMICAL RESISTANCE
-  DRINKABLE WATER APPLICATIONS
-  LOW ROUGHNESS
-  HIGH RESISTANCE TO TEMPERATURE AND PRESSURE
-  OXYGEN DIFFUSION BARRIER
-  SOUND INSULATION
-  RAW MATERIAL: PE-RT TYPE II
-  EASY AND FAST INSTALLATION
-  ECO-FRIENDLY
-  NATIONAL AND INTERNATIONAL CERTIFICATIONS

PIPE MARKING

The following sequence must be printed once per meter in all pipes.

Example:

HR HELIROMA HELIKLIMA ISO 21003 PE-RT / AL / PE-RT (PE-RT type II) Ø mm AENOR 001/847 DIN 16833 SKZ A571 CLASSE 1-2-4-5/6 bar (de 0°C a 95°C 10 bar à excepção de Espanha) L DD/MM/YYYY HH:MM N°OP Made in Portugal

MARKED SYMBOL	DESCRIPTION
HR Heliroma	Manufacturer's name
HELIKLIMA	Product trade mark
ISO 21003	Product Standards
PERT-AL-PERT (PE-RT type II)	Composition of the pipe
de x e	Nominal outside diameter x Nominal wall thickness
AENOR, SKZ	Certificates, Approvals
1/6 2/6 4/6 5/6 bar 50 years	Application class with design pressure (according ISO 21003)
L	Machine number
DD/MM/YYYY HH:MM	Date of manufacture
N°OP	Production order number
Made in Portugal	Manufacturer information

DIMENSIONS AND FLOW RATE

DN	Wall Thickness (mm)	Series	Speed (m/s)	Flow Capacity		
				m ³ /h	L/s	L/h
16	2,0	3.5	2	0,814	0,226	814
18	2,0	4.0		1,108	0,308	1108
20	2,0	4.5		1,448	0,402	1448
25	2,5	4.5		2,262	0,628	2262
32	3,0	4.8		3,823	1,062	3823
40	4,0	4.5		5,791	1,608	5791
50	4,5	5.1		9,506	2,641	9506
63	6,0	4.8		14,708	4,086	14708
75	7,5	4.5		20,358	5,655	20358
90	8,5	4.8		30,135	8,371	30135
110	10,0	5.0		45,804	12,723	45804

FITTINGS

HELIROMA develops and produces not only pipes, but also fitting systems tailored to specific applications. Complex systems and different applications require a wide range of fittings which HELIROMA provides.

KLIMAPRESS fittings range comprises PPSU and brass fittings, with a press fit technology, U profile, that creates reliable, versatile and long lasting connections. HELIROMA fittings - couplings, elbows, tees, valves are some of the components that cover all needs and provide solutions for fast and leak safe installation.

All fittings exceed the requirements of drinking water distribution as well as heating piping systems.



KLIMAPRESS PPSU

KLIMAPRESS PPSU is a range of press fitting made of Polyphenylsulfone – PPSU, which offers one of the best performances within sulfone grade.

This polymer which has excellent characteristics such as: high impact strength, high chemical resistance, excellent oxidation resistance, low weight and low roughness that deliver high durability and a long-lasting performance. The perfect solution for most demanding applications, for example, the ones that require continuous exposure to hot chlorinated water. The ultimate quality of PPSU, has already been proven over many years, which makes PPSU fittings widely used to replace brass in pressurized hot water applications.

PPSU fittings are manufactured with optimized elements to ensure a simple and secure installation.

The pressing sleeves, made of stainless steel, have an inspection window to check the penetration depth of pipe before pressing. The most important characteristics are the protection of the O-rings from damage, the finished connection high pull-out and the bending resistance. In each sleeve the production order and the diameter is marked.

The EPDM O-ring, a high-temperature and aging resistant O-ring fitted into a groove, provides sealing between the fitting insert part and inner wall of the pipe.

HELIROMA KLIMAPRESS PPSU fittings have been designed to be used with HELIKLIMA multilayer pipe and KLIMAPRESS fittings.

The range of KLIMAPRESS PPSU is available from Ø16 mm up to 32 mm in several configurations. The threaded transition fittings have two types in order to improve performance: male fittings with thread made of PPSU and female fittings with brass thread that meets to the 4MS regulations.

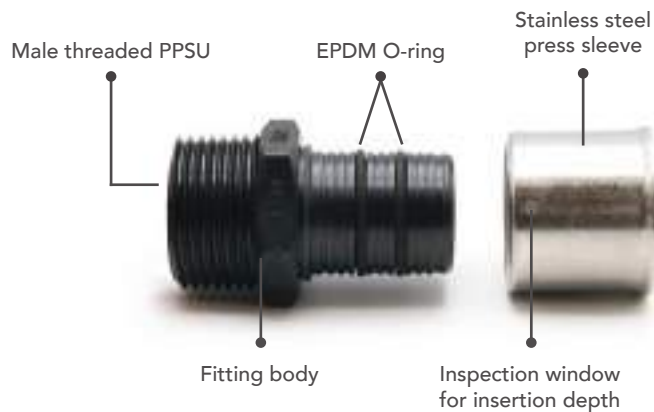

KLIMAPRESS PPSU ADVANTAGES

- 100% compatible with existing HELIROMA components and tools;
- High mechanical resistance;
- Highest reliability and durability;
- Very low stress crack sensitivity;
- Highly resistant to corrosion and oxidation;
- Flow optimised design;
- Visual assurance of pipe position;
- Quick Installation;
- Eco-friendly;
- Certification.



KLIMAPRESS

KLIMAPRESS fittings are made of brass – CW617N, a brass approved by 4MS. A special brass to ensure greater resistance to corrosion and oxidation.

The fittings are manufactured with optimized elements:

- Stainless steel press sleeve geometry;
- Stop ring and press jaw guide ensure simple free pressing;
- EPDM O-rings ensure an absolute watertight connection between the support sleeve and inner pipe wall.

After pressing, the connection is durable and highly strength resistant. Each sleeve has the indication of the diameter and the production order engraved, thus assuring product traceability.

HELIROMA KLIMAPRESS fittings have been designed to be used with HELIKLIMA multilayer pipe and KLIMAPRESS PPSU fittings.

A range of KLIMAPRESS is available from Ø16 mm up to 75 mm with different configurations such as couplings, elbows, tees, reducers, threaded elements and valves, to complete the system.

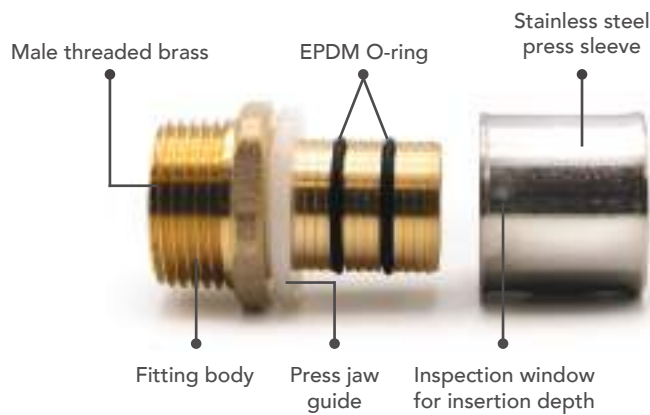

KLIMAPRESS ADVANTAGES

- 100% compatible with existing HELIROMA components and tools;
- Dimensional range Ø 16-75 mm;
- Fittings produce without the need for nickel plating, avoiding galvanic treatment;
- Fitting body made of brass 4MS approved;
- Highly resistant to corrosion and oxidation;
- Flow-efficient design;
- Visual assurance of pipe position;
- Quick Installation;
- Certification.



FLANGED FITTINGS

The flanged fitting is composed by two brass parts, on the inside an EPDM O-ring, a catch and a compression ring, additionally, to provide greater robustness on the transition area, pipe-fitting, the fitting has a stainless-steel nucleus.

The mechanical clamp that connects the fitting body to the pipe, is assured by 4 metal screws.

Available from diameter 75 mm up to 110 mm, flanged fittings ensure fast and safe installation even under the most difficult conditions.



MULTILAYER SYSTEM

Different fitting concepts – one multilayer pipe

SYSTEM

HELIROMA multilayer system made of composite material, where pipes and fittings are connected by press fitting to create a permanent, leakproof system. With a large selection of multilayer pipes and fittings in the dimensions 16 to 110 mm, HELIROMA offers the security that is required for all installations.

HELIROMA multilayer system is suitable for both risers and distribution systems as well as for reticulation, under the condition mentioned on the table below. All currently available sanitary equipment and fittings can be connected to the system.

Open System: The permissible continuous operating temperature is between 0 and 70°C at a maximum continuous operating pressure of 10 bar. The short-time exposure up to 95°C for a maximum of 100 hours in 50 years.

Closed System: The permissible maximum continuous operating temperature is 80°C at a maximum continuous operating pressure of 10 bar. The short-time exposure up to 100°C for a maximum of 100 hours in 50 years.

APPLICATION	OPERATION TEMPERATURE (°C)	MAX OPERATING PRESSURE (bar)	HELIKLIMA MULTILAYER	KLIMAPRESS PPSU	KLIMAPRESS
Heating system – water closed circuit	0 - 80	10	✓	✓	✓
Hot and cold water	0 - 70	10	✓	✓	✓
Ultrapure water	0 - 40	10	✓	✓	
Cooling water system without antifreeze	0 - 70	10	✓	✓	✓
Cooling water system with antifreeze	-10 - 40	10	✓	✓	✓
Cold Water	0 - 20	10	✓	✓	✓
Water for industrial application	0 - 40	10	✓	✓	✓
Rainwater - pH>6	0 - 40	10	✓	✓	
Saline water	0 - 70	10	✓	✓	
Inert gases	40	10	✓	✓	✓

Note 1: areas of application not contained in this technical information, or water with highest requirements in terms of organic constituents, require advice from HELIROMA Technical department.

Note 2: in case of exceeding the maximum permanent operating temperatures, HELIROMA multilayer system can't be connected directly to this kind of systems. It has to be ensured that in every situation the maximum limits of use of the system are not exceeded.



INSTALLATION GUIDELINES

GENERAL RECOMMENDATIONS

Before starting to work with HELIROMA's products it is very important to read the technical catalogue:

- HELIROMA's systems have to be assembled according to HELIROMA's instructions;
- For applications or conditions not mentioned, make sure to obtain HELIROMA's technical approval;
- All regulations and directives have to be fulfilled on designing and installation phases;
- Product warranty is valid only for HELIROMA's products.

DESIGNING GUIDELINES

The main goal of determining the pipe dimension is to supply the user with sufficient hygienically perfect drinking water, under optimum pressure conditions.

Compliance with local regulations is mandatory and responsibility of the installer.

In order to ensure the minimum flow pressure, before the points of use, the pressure losses arising from liquids flowing in piping systems must be considered when dimensioning drinking water systems. If the pipe is sized too small, the flow velocity and the pipe friction pressure gradient increase, this leads to higher flow noises and higher power consumption of the circulation pump.

There are two ways to determine the pipe diameter, a simplified and differentiated method of calculation. The simplified calculation is recommended for small-scale projects and simple drinking water application. The differentiating calculation is more precise and gives a highest accuracy dimension of the installation, the method includes all pipes and local resistances.

The linear pressure loss through pipe friction is the product of the pipe friction pressure gradient – R and the pipe length – L.

R is dependent on the volumetric flow rate, inner diameter, piping material and temperature. HELIROMA recommends that the maximum flow rate would be 2,0 m/s to collective supply pipes, singles supply lines 4 m/s, but complying with national regulations is highly recommended.

LINEAR PRESSURE LOSS EQUATION

$$\Delta P = R \times L$$

ΔP	Linear pressure loss (Pa)
R	Pipe friction pressure gradient (Pa/m)
L	Pipe length (m)

Pressure Loss Tables, please consult Annex C.

Pressure losses are caused by the individual resistance from fittings and bent pipes. The essential factor for determining an individual resistance is the pressure loss coefficient zeta value - ζ , a dimensionless parameter that represents the resistance to the dynamic pressure of water. The pressure loss coefficient must be determined empirically.

FIXING TECHNIQUES

Appropriate measures must be taken to absorb the change in length, depending on the extent of the change in length.

Along pipe assembly, it is important to distinguish between **Fixed Point** and **Sliding Point**:

Fixed Point (FP) – prevents the movement of the pipe, the forces of expansion of the pipe as well as probable additional loads are accommodated in this point, the fixed points segment the pipe on small sections. The connection between pipes and clamps is very strong, so the material in contact should be smooth to avoid possible problems damages on the pipe's surface.

Sliding Point (MP) – is the same that sliding point and is the point where the axial movement is allowed, without damaging the pipe. Point where the clamps are not well tighten to the pipe. They should be placed on a vertical or horizontal directions and it is fundamental that free pipes movement is assured. Only the weight forces of the pipe system need to be considered on the sliding points project.

Clamps and supports must be selected in accordance with the outside diameter of the pipe. For more details about clamp types and dimensions please see pages 45 and 46.

THERMAL EXPANSION

Due to laws of physics, all piping materials expand when heated and contract when cooled.

Multilayer pipes expand differently due to thermal effects depending on the material of different layers. The thermal expansion results from the variations in operating temperature and installation temperature. The higher the temperature differences, the greater the change in length.

However, HELIKLIMA system has smaller linear expansion compared to monolayer plastic pipe solutions.

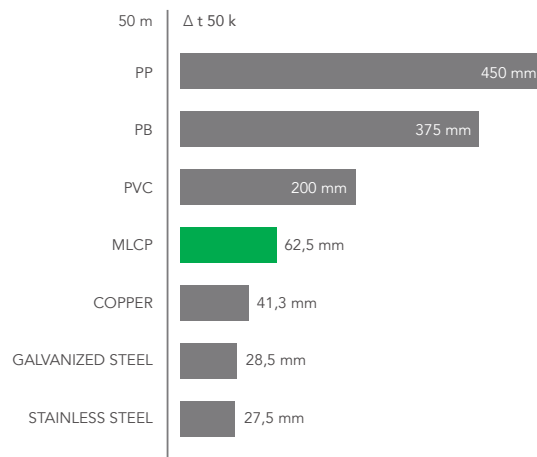

The thermal expansion in length is calculated using the following equation (Annex A, table of the pipe linear expansion):

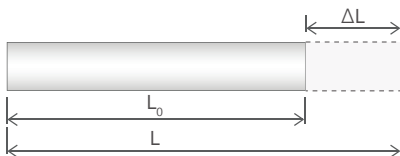

THERMAL EXPANSION FORMULA

$$\Delta L = L - L_0 = L_0 \times \alpha \times \Delta T$$

- ΔL Linear expansion (L-L₀) (mm)
- L Final length of the pipe, at T temperature (m)
- L₀ Initial length of the pipe, at T₀ temperature (m)
- α Linear expansion coefficient: $\alpha = 0,026 \text{ mm/m}^\circ\text{C}$
- ΔT Variation of pipe temperature, in °C (T-T₀)

The length variation must be considered when planning the pipe installation, the creation of expansion space, the installation of expansion compensators and positioning of fixed points and sliding points. The change in length of the pipes must always be absorbed or guided.

The bending and torsional stress that happens during pipe operation are absorbed when the expansion compensation is taken into account.

All pipes are to be installed in such way that the thermal length variation is not obstructed.

Compensation is always performed between two fixed points and changes in direction.

SUPPORT INTERVALS

Type and distances for pipe support depend on pressure, temperature and installation characteristics.

Fixing points must be laid out according the maximum weight with water on the segment in accordance with recognized practices. It is recommended to place the pipe fasteners as close as possible to the fittings, also ensure that the length variation is not obstructed.

Pipe brackets are fastened to the wall or ceiling with threaded rods or other support elements, the required thickness of the material must be chosen depending on the distance from ceiling or wall and to guarantee a slide or fixing of the system with a regular needed force.

The table below shows the maximum distance between pipe clamps.

Pipe dimension (mm)	Maximum distance between pipe clamps (m)	
	Horizontal (a)	Vertical (b)
16x2,0	1,2	2,30
18x2,0	1,2	2,40
20,2,0	1,3	2,60
25x2,5	1,5	3,00
32x3,0	1,6	3,00
40x4,0	2,0	2,20
50x4,5	2,0	2,60
63x6,0	2,2	2,85
75x7,5	2,4	3,10
90x8,5	2,4	3,10
110x10,0	2,4	3,10

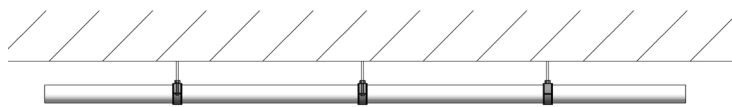

a) horizontal installation

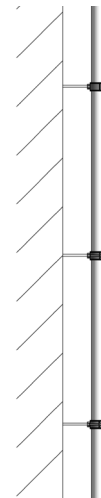

b) vertical installation

Installing multilayer on concrete floor must be planned free of crossings. Pipes on the floor should be straight as possible and parallel to the axis and wall. A fixing distance of 800 mm is recommended, the pipe must be fixed within a distance of 300 mm before and after each bend.

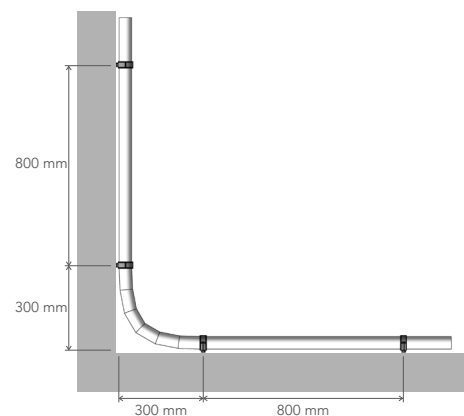

DEFLECTION ARM

The expansion is absorbed by a change of direction in the pipe. The advantage of using a deflection arm is that it eliminates additional costs or maintenance. Costs that would, for example, be incurred by installing axial expansion fittings.

The calculation of the deflection arm length comprises two steps: calculation of the change in length (ΔL) and the calculation of the deflection leg length (L_b).

On riser pipes which run through several floors and therefore have more fixing points, the change in length between the individual anchor points must be absorbed by bending arms.

If changes in length cannot be compensated by changes in direction, expansion joints (U bends) must be fitted in straight pipe runs. The longer pipe section (L_1 or L_2) is used as pipe length L to calculate the deflection leg.

DEFLECTION ARM LENGTH FORMULA

$$L_b = C \times \sqrt{d_e \times \Delta L}$$

L_b Deflection Arm (mm)

d_e Outside diameter (mm)

ΔL Linear expansion

C Pipe specific constant (multilayer)

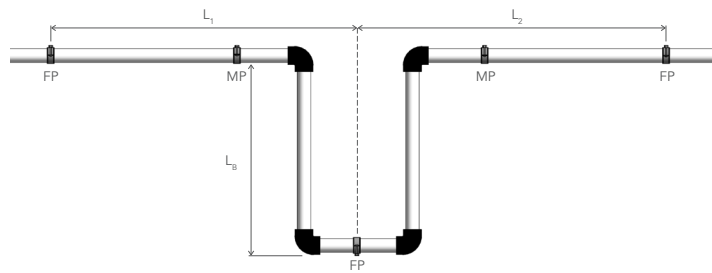
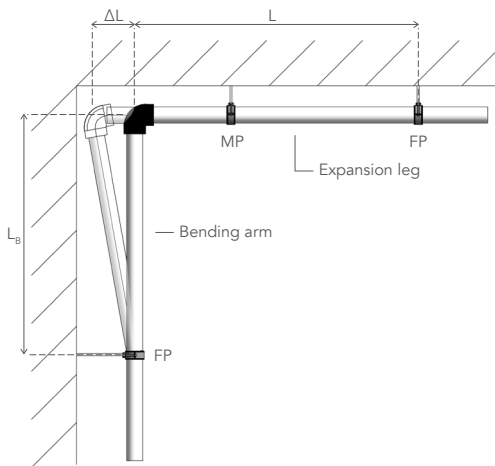

Example:

Installation temperature: 20°C

Operation temperature: 60°C

ΔT : 40°C

Pipe length: 25 m

Pipe dimension: 32 x 3,0 mm

Thermal expansion coefficient: 0,026 mm/w K

Calculation of the thermal expansion: ΔL

$$\Delta L = 25 \times 0,026 \times 40$$

$$\Delta L = 26 \text{ mm}$$

Calculation of the deflection leg length: L_b

$$L_b = 30 \times \sqrt{32 \times 26}$$

$$= 865 \text{ mm}$$

MINIMUM DIMENSION FOR FITTINGS COMBINATION

The perfect installation of multilayer system implies a minimum distance between fittings to ensure the expansion-contraction of the pipe. The table below shows the minimum pipe length between fittings for an HELIKLIMA system.

Pipe dimension	L_{MIN} (mm)
16x2,0	50
18x2,0	50
20,2,0	55
25x2,5	70
32x3,0	70
40x4,0	100
50x4,5	100
63x6,0	150
75x7,5	150
90x8,5	160
110x10,0	160

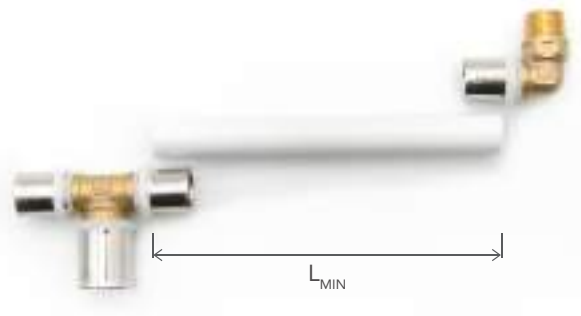

BENDING

HELIKLIMA multilayer from diameter 16 up to 32 can be bent with a bending spring or bending tool. The minimum bending radius may not be less than those specified for each producer, according to pipe characteristics. Read more on the chapter assembly techniques.



CORROSION

Corrosion is the reaction of a material to its environment, which causes a measurable change in the material and can lead to failure in the function of a component or an entire system. Different types of corrosion can occur depending on the material and application area (internal corrosion, external corrosion or both).

Corresponding corrosion measures must be implemented to prevent this phenomena from occurring.

HELIROMA multilayer pipe is protected against corrosion, that is only likely to occur if the pipe is laid in an aggressive or permanently damp environment and only on open-cut sections.

Fittings and compression sleeves have to be protected against contact with brickwork or with screed, cement, plaster, bonding agents, aggressive media and other materials and substances which can cause corrosion.

Ensure that the employed sealants, cleaning agents, building foams, insulation, protective tape, adhesive tape or thread sealant etc. do not contain any components which cause stress cracking or corrosion, e.g. ammonia, ammonia-bearing, aromatic and oxygenated solvents (e.g. ketone and ether), chlorinated hydrocarbons or chloride ions which can leach.

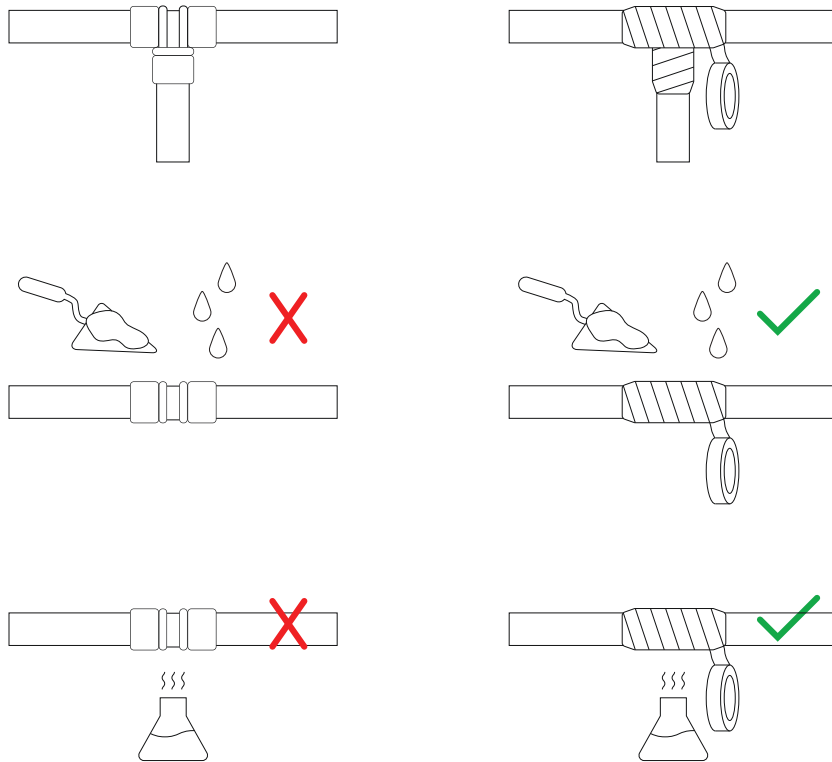

Corrosion protection is fundamental in the following areas:

- Aggressive environments, areas where corrosive gases, vapours and liquids can be present;
- Permanently damp environments.

Sealing tape or other suitable materials can be used for corrosion protection.

Protection against corrosion is not required if the pipe is insulated.

KLIMAPRESS PPSU system cannot be in contact with solvents or construction materials containing solvents, such as: paint; sprays; foams; adhesives. The contact between aggressive chemicals and that system may cause damage to the polymeric structure.

Note: during the installation KLIMAPRESS PPSU do not require use of any chemical substances or additional lubrication. It's not recommended the use of chemical sealants, for examples liquid Teflon or adhesives.

INSULATION

The insulation of multilayer piping system must fulfil several purposes, depending on the construction requirements: anticondensation insulation; thermal insulation; sound insulation; absorption of the low thermal expansion of the pipe.

It is essential that the choice of insulation materials is compatible with the pipe material, the information provided from manufacturer must be observed. All country insulation rules and requirements must be fulfilled.

Potable cold water supply pipes must be protected against heat loss and condensation, water quality cannot be affected by heat.

Before applying the insulation, the prescribed pressure test must be performed.

The multilayer pipe alone has better insulation performance when compared with metallic solutions.



OPERATION

The owner or manager of the pipe installations is responsible to keep the system working properly.

In case of absence of use, the drinking water supply should be shut off. When the system resumes operation, it is advised the flow of water according to EN806-5.

Depending on the size of the system, the presentation of written operating instructions is advised.

In large buildings the maintenance and hygienic plan is important, all interventions should be recorded.

If the operating parameters are exceeded, the pipes and connections may become overstrained. Not adhering to the operating parameters is highly not recommended.

Keeping within the operating parameters must be ensured by safety/control equipment (e.g. pressure reducers, safety valves, etc.).



LEAKAGE TEST

All HELIROMA products must be submitted to a leakage test. The product warranty is only valid if the leakage test has been performed, on the date the system has been installed.

Before the pressure test, it must be ensured that all components of the installation are freely accessible and visible, in order to identify unpressed or incorrectly installed fittings. Pressure test must be carried out before the system is put into operation and before they are insulated and sealed.

It is recommended to perform the pressure test with compressed air or inert gas if the pipeline system is to remain unfilled after a pressure test. When the pressure test is performed with water, despite draining the system, residual water can remain in some sections, this is an ideal environment for bacteria.

LEAK TEST WITH COMPRESSED AIR OR INERT GAS

A pressure test with compressed air or inert gases is carried out in two stages: leak test (checking the system for leaks. Unpressed and inadequately screwed connections can be identified in this way) and load test (checking the system for the quality of the material and installation process). Both stages must be performed under recognized engineering best practices.

Before the leakage test, all equipments, water heaters, fittings, or pressure valves or pressure vessels must be disconnected from the system. The air volume can affect safety and testing accuracy.

All lines must be directly sealed with material which can withstand the test pressure. Closed stop valves are not enough to a tight shut-off.

Before starting the test stages, it is important to wait for temperature equalisation and steady-state condition after pressure build-up.

For safety reasons, the test pressures are set to a maximum of 3 bar. The pressure should be gradually increased up to the required pressure. If a pressure drop occurs during the test period, there is a leak in the system, repeat the leak test.

Leak test – Stage 1

All pipe connections must be visually inspected, before starting the test.

The manometer used must have an accuracy of 1 mbar.

The test pressure is 150 mbar. For systems up to 100 litres volume, the test must run for, at least, 120 minutes. For bigger volume systems, The time must be extended 20 minutes per additional 100 litres.

During the test stages cannot occur any leakage.

Load Test – Stage 2

Following the leak test, the load test is carried out.

Pipe sizes $d_e \leq 63$ mm, for a system volume up to 100 litres, the pressure is increased to 3 bar maximum.

Pipe sizes $d_e > 63$ mm, for a system volume up to 100 litres, the pressure is increased to 1 bar maximum.

For a system volume of up to 100 litres, the test time must be at least 10 minutes.

The sealing of the system must be evident, and after that must be confirmed with a written record, that has to be signed by the installer, stating place and date and sent to HELIROMA technical department.

Please refer to the test protocol recommended in Annex D.

LEAK TEST WITH WATER

The pressure test checks the tightness of the pipe installation as well as the axial restraint of the connections.

All pipe connections must be visually inspected, before starting the test. The local regulations and/or standards must always be considered during the pressure test.

Before starting the test stages, it is important to wait for temperature equalisation and steady-state condition after pressure build-up.

If the pressure falls during the test period, there is a leak in the system, meaning that the leak test must be repeated.

There must be no drop in pressure and no visible indication of leakage.

The sealing of the system must be evident, and after that must be confirmed with a written record, that has to be signed by the installer, stating place and date and sent to HELIROMA technical department.

Please refer to the protocol recommended in Annex D.



Potable water is the most important element of life. To ensure it remains in hygienically perfect conditions – from the main line connection to the outlet, appropriate measures should be taken in order to inhibit an unhealthy concentration of legionella in hot water tanks and their hot water distribution systems.

Drinking water hygiene starts with proper designing. When designing and dimensioning drinking water pipes, the next points must be taken into account:

- Use of certified/approved installation material;
- The shortest possible pipelines, small but hydraulically suitable pipe diameters in order to achieve the shortest possible residence time of water in the system;
- Prevent water stagnation in parts of the system that don't have water flowing through;
- Avoid warming cold water distribution systems by environmental influences;
- Unused parts of the network must be drained and disconnected;
- Avoid unfavourable temperature ranges, the temperature range in which increased legionella growth appears is between 30°C and 45°C. In order to reduce the risk of legionella growth, cold water in pipes and cisterns should not exceed a temperature of 20°C, while hot water should be stored at a temperature between 55-60°C.

Disinfection is a very important process in the supply of drinking water. Potable water pipes can be thermally or chemically disinfected. In the case of chemical disinfection, a distinction is made between continuous and discontinuous disinfection.

CHEMICAL DISINFECTION - DRINKING WATER

Chemical disinfection of drinking water includes a chlorine-based technology and is intended to maintain a residual concentration in the water to provide protection from post-treatment contamination and during storage.

In case of continuous disinfection with a chlorine substance, it can be used with a content of free chlorine of up 0,3 mg/L (value in accordance with 2001 drinking water ordinance). The installation temperature should not exceed 70°C to avoid system early oxydation. Residual disinfection is not necessary where there is no evidence of water contamination, unless specifically required.

Recommendation of the World Health Organization – guidelines for Drinking-water quality (4TH Edition) advises that for effective disinfection, there should be residual concentration of free chlorine $\geq 0,5$ mg/L after at least 30 minutes contact time at pH<8,0. A chlorine residual should be maintained through the distribution system. At the point of delivery, the minimum residual concentration of free chlorine should be 0,2 mg/L.

CHEMICAL DISINFECTION - SYSTEM

The disinfection of a system is a discontinuous measure, unlike disinfection of a drinking water system from the area of contamination to the tapping point of consumption. Generally, a disinfection is to be performed for a short period of time, only in case of an identified contamination.

For an effective disinfection, the free residual chlorine concentration should be 50 mg/L for one hour. The free residual chlorine must be measured at the end of the contact period and if it is less than 30 mg/L, the disinfection process must be repeated. During the disinfection process the maximum temperature is 30°C.

Measures should be taken to ensure that no drinking water is consumed during the disinfection process and the subsequent cleaning phase.

Disinfection measures carried out incorrectly can damage the potable water installation. It is not permitted to use a combination of several chemical disinfectants. After disinfection, the system should be thoroughly flushed with fresh water until the free residual chlorine is at the level present in the potable water supplied.

IMPORTANT NOTES

- **Chemical and thermal disinfection cannot be combined.**

- Carrying out shock disinfection at high temperatures, pressures or chemical concentrations, is not allowed, as premature material damage and failure can occur.

- Chlorine dioxide is nowadays the most used disinfectant in some countries. This is explained by the fact that chlorine dioxide is easier to add, cheaper to produce than chlorine, but it is more oxidant. However, it does not provide a residual effect, as chlorine does. The main concerns with chlorine dioxide are with the residual concentrations of chlorine dioxide and the by-products chlorite and chlorate.

The use of chlorine dioxide requires close monitoring. Materials in the drinking water systems are very affected due to the high oxidation potential of a chlorine dioxide.

Along with sealing materials, piping components are damaged too, regardless of whether they are made of plastic or metal. According to the above explanations, chlorine dioxide should not be used in systems as a disinfecting agent.



INTEGRATION OF OTHER SYSTEMS WITH HELIROMA MULTILAYER SYSTEM

Components from different HELIROMA systems may only be mixed with one another if HELIROMA expressly indicates this option.

HELIROMA does not guarantee compatibility between HELIROMA products and third-party products.

If you choose a mixed installation, you will only receive the pipe manufacturer's product warranty for the pipe itself and the fitting manufacturer's warranty for the fitting itself, but not for the connection point and certainly not for the entire installation.

In cases of mixed installations, the 10-year HELIROMA's Declaration of Warranty will not generally be issued for our material. The legal warranty period, though, will still apply.

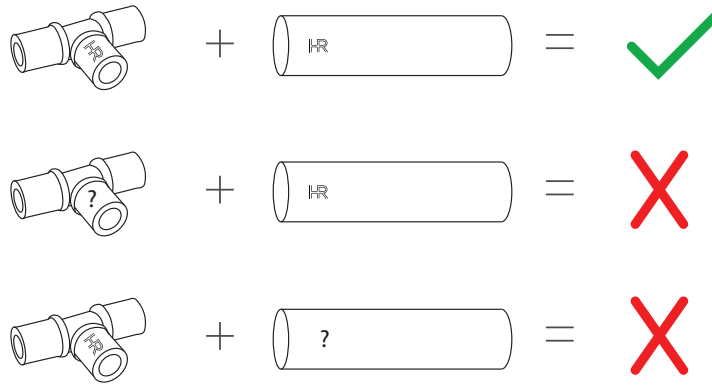

TRANSPORT AND STORAGE

HELIROMA pipes can be stored outdoor or indoor, preferably in a covered area, protecting them from direct sunlight and low temperatures.

Pipes and fittings must not be exposed to direct UV-radiation, for long periods. This radiation has effects on the durability of all polymer plastics. Do not store permanently outdoor.

Despite the high quality and resistance of all HELIROMA products, they should be handled with caution. Do not drop the pipes when unloading them and protect them from falling object, or equipments. The process of loading, transport and subsequent unloading should be carried out making sure that pipes and fittings do not take any damage.

Pipes and fittings should be kept in their original packaging if at all possible until processed. Damaged, bent or deformed pipes must not be processed.

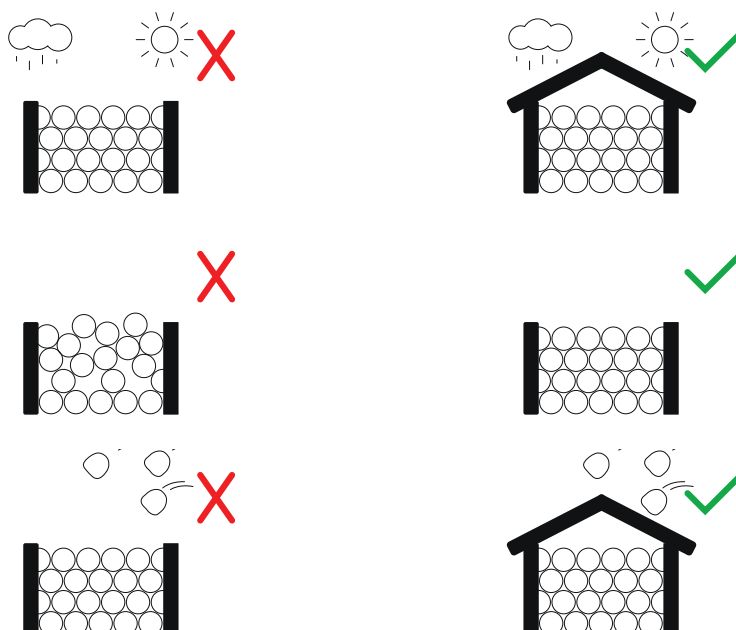

ASSEMBLY TECHNIQUES

In order to obtain good installation results of HELIKLIMA systems, the following recommendations are considered important by HELIROMA and should be taken into consideration, as well as the pressing techniques.



RECOMMENDATIONS FOR THE APPROPRIATE USE OF THE SYSTEM



SYSTEM SAFETY

HELIROMA's multilayer system is designed to guarantee the maximum system safety.



TRANSPORTATION

All system components must be transported, stored and processed in a way that ensures the installations will work perfectly.



STORAGE

The components should be stored according to their system in order not to be mixed with components from other application areas.



SEALING

To seal the threaded connections use Teflon or hemp tape to avoid leaks, do not use excessive thread sealant and tighten without excess force. The assembly of a threaded connection should be carried out in accordance with DIN 30660.



APPROVED MATERIALS

All materials and auxiliary materials used must be free of substances that can cause stress corrosion or cracking (e.g. chloride or ammonia compounds).



INSTRUCTIONS

The relevant installation instructions for individual system components and tools must be followed.



TOOLS

For correct handling, all devices and tools must be observed. The perfect condition of the tools and products is mandatory.



DESIGNING

In case you did not understand the safety advice or the individual assembly instructions, or if they are not clear, please contact HELIROMA's technical department.



CLEANING

Keep your workplace clean and free of obstructions, ensure adequate lighting at your workplace.

INSTALLED TEMPERATURES

HELIROMA multilayer system components (pipes and fittings) can be installed at an environment temperature between -10 and +50°C. The permissible temperature ranges for pressing tools can be found in the respective operating instructions of the devices.

PIPES

Pipes should be kept in their original packaging if at all possible until installed.

Damaged, bent or deformed pipes cannot be installed.

FITTINGS

HELIROMA fittings must not be thrown or otherwise handled improperly. The fittings should be stored in their original packaging until installed in order to protect them from damage or contamination.

Damaged fittings with damaged O-rings cannot be processed.

BENDING

HELIROMA multilayer pipe can be bent, according to the following rules:

- Only pipes diameter 16 up to 32 mm may be bent;
- Bending process must be performed with specific tools;
- The inside of the bend should not be dented or compressed;
- The outside layer must not be damaged;
- The bending of multilayer pipes using open flames or other heat sources is not permitted;
- Do not bend more than once at the same point;
- The minimum bending radius is in relation to the centre of the pipe;
- If a previously pressed system pipe is to be bent, the connection points must be secured;
- After bending, ensure that there are no imperfections, wrinkles or bulges and all layers are undamaged;
- Pipes installed through ceiling recesses and wall cut-outs may never be bent over edges;
- Observe the operating instructions of the bending tool, the user manual and following them.



The bending of the pipes must be carried out in accordance with the minimum values provided on the following table:

Pipe Dimension $d_e \times e$ (mm)	16x2,0	18x2,0	20x2,0	25x2,5	32x3,0
r_{min} (mm)	64	72	80	100	128

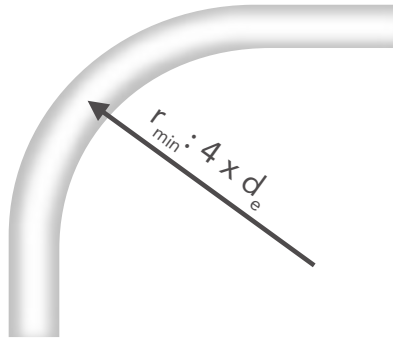

- Bend the pipe only with the correct tools;
- Do not use heat sources to bend the pipe;
- Respect the minimum bending radius.



CAUTION
INCORRECT BENDING

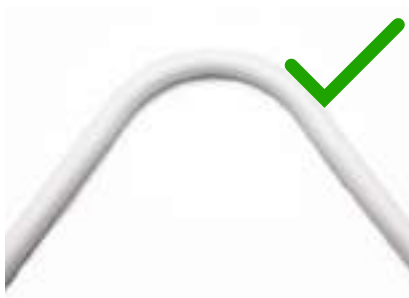

FITTINGS ASSEMBLY

KLIMAPRESS PPSU AND KLIMAPRESS

HELIROMA's multilayer system is easy and quick to install onsite.

- Only make the joint with the appropriate installation tools;
- The instructions of use of each pressing tool must be observed;
- Check the tools regularly for visible defects and damages that could affect safety, and regularly clean and lubricate them;
- Use the correct pipe cutter for each pipe;
- Only use the pressing jaw if it is in perfect working conditions, observe the safety notes for the cleaning and anti-corrosion protective agents used;
- The diameter of the pressing jaw must match the diameter of the pressfittings;
- System pipes and pressfittings are tension-free;
- Threaded connections must be made before pressing avoiding stress on the press fitting connection;
- No undue force may be used when working with brass or PPSU components;
- Threaded connection may be performed with suitable tools, that may not be lengthened to increase the force when tightening;
- Assure the minimum space required for the pressing process with the pressing machines selected;
- In case of permanent exposure or constant humidity and pH value greater than 12.5, the metal components of fittings must be protected with a suitable jacket (e.g. insulating tape).





1) Cutting: Cut the pipe to length at right angle, perpendicular to the pipe axis;



2) Calibration and chanfering: Calibrate and chanfer the pipe ends, check if there is a uniform circular debur (remove chips from system pipe);*



3) Lubrication: If necessary, lubricant the contact area with an appropriate lubricant approved for installations on drinking water.
**



4) Inserting the fitting: Insert the pipe fully into the fitting. Confirm the totally depth pipe on the inspection window;





5) Pressing: Position the press jaw (U profile) on the fitting sleeve and on the pipe and press until completion of the pressing operation, without any interruption until the sound signal. Once the fitting has been pressed, avoid placing the joint under any tension.



6) Completion of Pressing: Remove the pressing device and open the jaw again;

* If use a calibrator to adapt a power drill, the maximum power is 450 rpm.

** Please see the topic CORROSION, page 207.

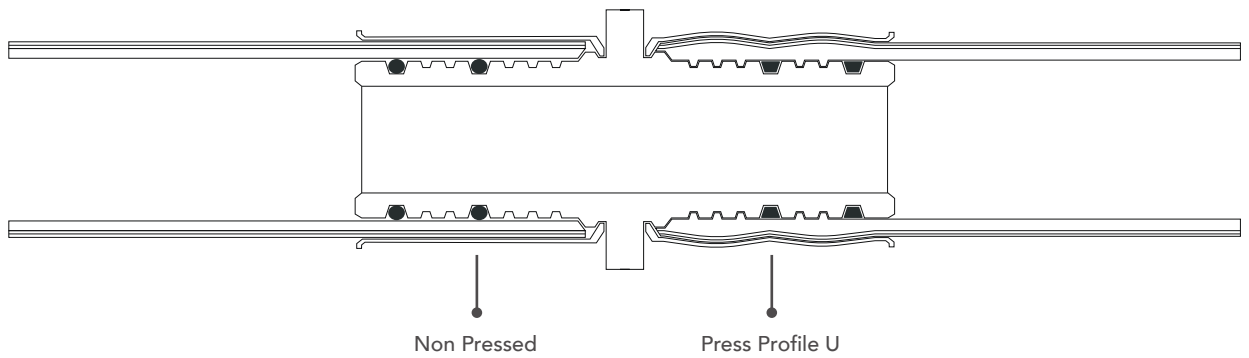

- Do not hold the pressing jaw with your hands during the pressing operation;
- Ensure that the pressing jaw is completely closed after pressing operation;
- Fittings that have been pressed incorrectly must not be pressed again;
- Replace any connection that has not been pressed correctly;
- Certify that the pipe is clean before connecting the fittings.



CAUTION
INCORRECT USE OF
THE FITTINGS



FLANGED FITTINGS

- 1) Check all components of the fittings;
- 2) Place the brass flange, then the brass nickel ring, the catch and the O-ring at the end of the outside of the pipe;
- 3) Insert the aluminium core inside the pipe;
- 4) Joint the brass flange and tighten the metal screws.



SYSTEM FEATURES

At every stage – from initial designing and on-site issue resolution to assured one-source supply and product certification at turn key – HELIROMA connects to better solutions and a outstanding service for our customers coming from the operating fields of heating/cooling, plumbing and infrastructure systems, the better partnerships.

The characteristics of HELIKLIMA pipes and KLIMAPRESS PPSU and brass make it highly reliable and extremely easy to install.

HELIKLIMA solutions ensure excellent quality and easy installation and add value to any building, characterized by a long service life and cost-effective maintenance. HELIKLIMA - solutions that meet today the requirements of tomorrow.



APPLICATIONS

Potable water is one the most controlled commodity goods. The choice of a drinkable water pipe system and its material is utterly important.

Choosing a material that does not react or interact with water or other fluids ensures that chemicals from de pipe and fittings will never transfer to drinking water.

Nowadays, multilayer pipes are so much used in drinkable water application which confirm the high hygienic qualities of the material, as well your physiologically and microbiologically harmless.

HELIKLIMA system solutions from HELIROMA are the optimal solution for drinking water applications, the hygienic suitability of the material is independently verified through test done from several accredited national and international entities.

All multilayer systems from HELIROMA are engineered for optimal performance to a wide variety of applications.

HELIROMA's solutions allow to optimize efficiency and economics of the installation with a higher safety factor.

FULL SYSTEM RANGE

HELIROMA piping systems can be used in nearly any pressure application and range in size from 16 to 110 mm. This allows installers to use one type of pipe for an entire system rather than mixing multiple materials and jointing methods.

An entire project can be done using HELIROMA pipes, eliminating the need for multiple tools sets and maintenance programs.

Transition threaded fittings make simple and easy the combination of HELIKLIMA pipes with other HELIROMA systems.

All multilayer fittings, either PPSU or brass, can be combined with all PP-R products from HELIROMA.



SUSTAINABILITY

Nowadays technical demanding products no longer place a load on the environment, HELIROMA has sustainability woven through it, with roots embedded in sustainable solution development and responsible manufacture.

On the pipe production an overall concept for recycling of discards and production waste exists, the processes are energetically efficient in order to have low impact on the environment.

HELIROMA is committed to protecting natural resources for future generations.

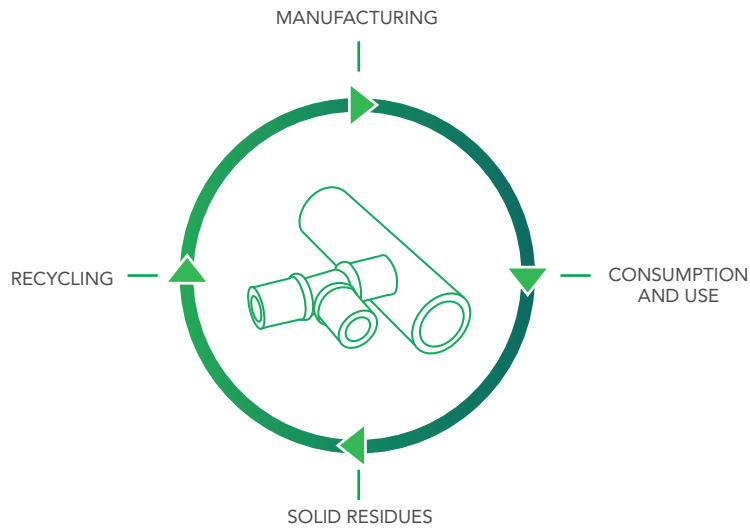

WARRANTY

All supplied products by HELIROMA installed according all procedures in HELIROMA catalogue, have 10 years warranty against manufacturing defects.

For further information, consult the general terms and conditions.



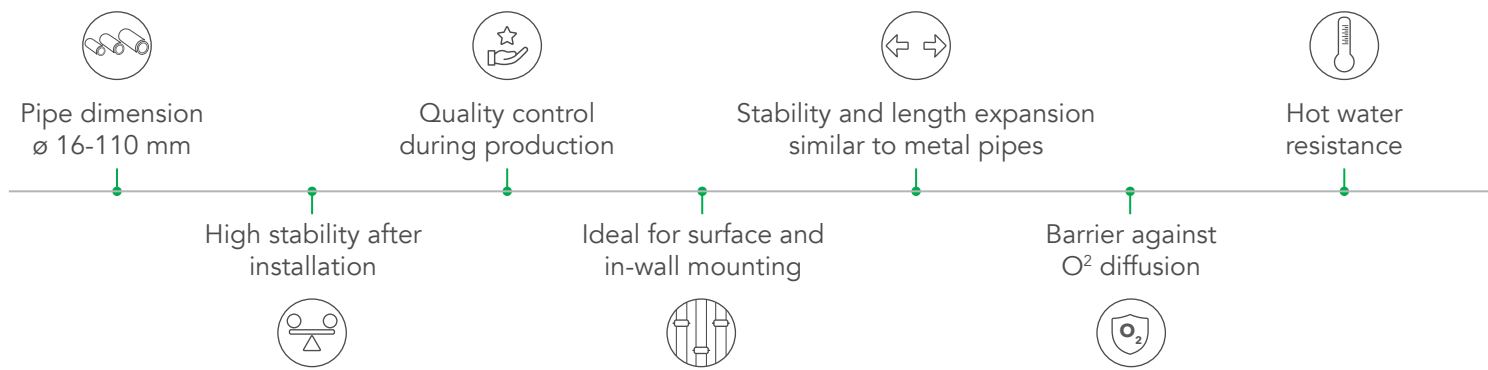

SYSTEM GENERAL ADVANTAGES

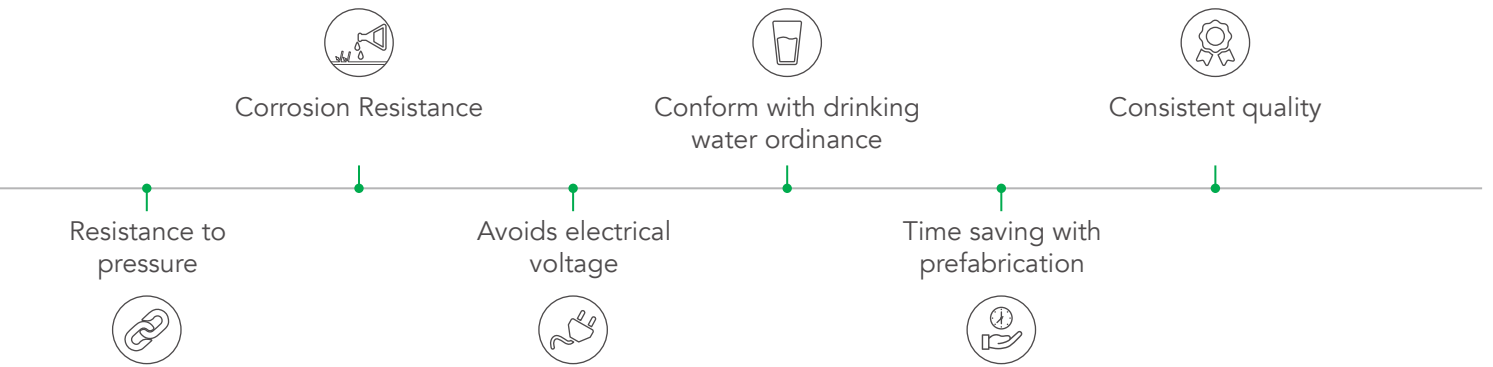

CERTIFICATIONS

All HELIROMA multilayer systems are manufactured in accordance with the national and international entities.

The high resilience of multilayer system is checked regularly through several tests during the production and at laboratory.

STANDARDS:

EN ISO 21003: Multilayer piping systems for hot and cold water installations inside buildings.

ISO 22391: Plastics piping systems for hot and cold water installations— Polyethylene of raised temperature resistance (PE-RT).

DIN 16833: Polyethylene pipes of raised temperature resistance (PE-RT) - PE-RT type I and PE-RT type II - General quality requirements testing.

RP001.71: Multilayer piping systems for hot and cold water installations inside buildings.

HR3.12: Specification for test and inspection: Plastic aluminium multilayer pipes.

EN ISO 9001: Quality management systems: requirements.



MULTILAYER | PRODUCT RANGE

- MULTILAYER PIPE
- KLIMAPRESS PPSU FITTINGS
- KLIMAPRESS AND FLANGED FITTINGS
- MULTILAYER TOOLS

MULTILAYER PIPE: PE-RT / AL / PE-RT HELIKLIMA

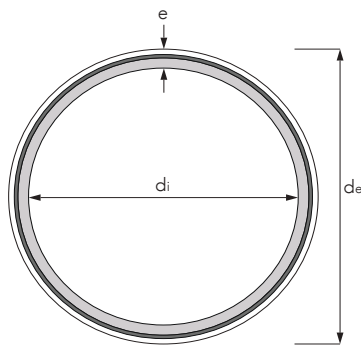
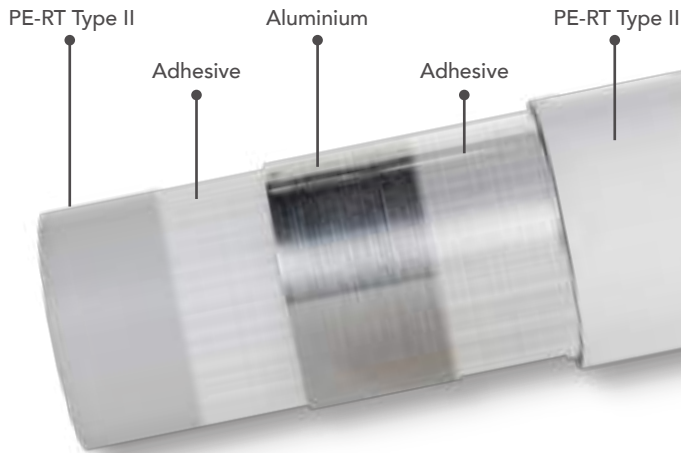

CHARACTERISTICS

SUPPLIED IN	ø 16-32 mm - coils ø 16-32 mm - 4 m bars ø 40-110 mm - 5 m bars
PRESS PROFILE	ø 16-75 mm - U ø 75-110 mm - Flanged
STANDARDS	EN ISO 21003 ISO 22391 RP 001.71 HR3.12



REFERENCE	dn NOMINAL DIAMETER	de OUTSIDE DIAMETER		e THICKNESS		di INSIDE DIAMETER	WEIGHT	MAX WEIGHT W/ WATER *	SERIES
		Min.	Max.	Min.	Max.				
		(mm)				(kg/m)			
P-PERTAL16	16x2,0	16	16,3	1,9	2,2	12	0,108	0,221	3.5
P-PERTAL18	18x2,0	18	18,3	1,9	2,2	14	0,121	0,275	4.0
P-PERTAL20	20x2,0	20	20,3	1,9	2,2	16	0,137	0,338	4.5
P-PERTAL25	25x2,5	25	25,3	2,3	2,7	20	0,207	0,521	4.5
P-PERTAL32	32x3,0	32	32,3	2,8	3,2	26	0,320	0,851	4.8
P-PERTAL40	40x4,0	40	40,4	3,8	4,3	32	0,510	1,314	4.5
P-PERTAL50	50x4,5	50	50,5	4,3	4,6	41	0,748	2,068	5.1
P-PERTAL63	63x6,0	63	63,6	5,7	6,3	51	1,192	3,235	4.8
PERTAL75	75x7,5	75	75,7	7,2	7,9	60	1,790	4,617	4.5
PERTAL90	90x8,5	90	90,9	8,2	9,2	73	2,700	6,885	4.8
PERTAL110	110x10,0	110	111	9,7	11	90	3,900	10,262	5.0

* Water max. weight calculated with pH₂O at 4°C;



PPSU FITTINGS

ELBOW 90°



CHARACTERISTICS

BODY	PPSU
SLEEVE	Stainless Steel
O-RING	EPDM
PRESS PROFILE	U
STANDARDS	EN ISO 21003
COMPATIBLE SYSTEMS	HELIKLIMA KLIMAPRESS PPSU Fittings KLIMAPRESS Fittings Flanged Fittings

REFERENCE	DIAMETER (mm)	SMALL BOX (un)	LARGE BOX (un)
P-K206016	16x16	44	264
P-K206020	20x20	28	168
P-K206025	25x25	18	108
P-K206032	32x32	10	60

FEMALE ELBOW



CHARACTERISTICS

BODY	PPSU
SLEEVE	Stainless Steel
O-RING	EPDM
PRESS PROFILE	U
STANDARDS	EN ISO 21003
COMPATIBLE SYSTEMS	HELIKLIMA KLIMAPRESS PPSU Fittings KLIMAPRESS Fittings Flanged Fittings

REFERENCE	DIAMETER (mm x in)	SMALL BOX (un)	LARGE BOX (un)
P-K208016	16x1/2"	26	156
P-K208020	20x1/2"	22	132
P-K208026	25x1/2"	16	96
P-K208025	25x3/4"	12	72
P-K208033	32x3/4"	8	48
P-K208032	32x1"	8	48

MALE ELBOW



CHARACTERISTICS

BODY	PPSU
SLEEVE	Stainless Steel
O-RING	EPDM
PRESS PROFILE	U
STANDARDS	EN ISO 21003
COMPATIBLE SYSTEMS	HELIKLIMA KLIMAPRESS PPSU Fittings KLIMAPRESS Fittings Flanged Fittings

REFERENCE	DIAMETER (mm x in)	SMALL BOX (un)	LARGE BOX (un)
P-K209016	16x1/2"	34	204
P-K209020	20x1/2"	28	168
P-K209026	25x1/2"	18	108
P-K209025	25x3/4"	18	108

LOOSE NUT ELBOW



CHARACTERISTICS

BODY	PPSU
SLEEVE	Stainless Steel
O-RING	EPDM
PRESS PROFILE	U
STANDARDS	EN ISO 21003
COMPATIBLE SYSTEMS	HELIKLIMA KLIMAPRESS PPSU Fittings KLIMAPRESS Fittings Flanged Fittings

REFERENCE	DIAMETER (mm x in)	SMALL BOX (un)	LARGE BOX (un)
P-K208017-L	16x3/4"	20	120
P-K208021-L	20x3/4"	15	90
P-K208025-L	25x3/4"	10	60
P-K208027-L	25x1"	10	60
P-K208032-L	32x1"	7	42
P-K208034-L	32x1 1/4"	5	30

WALL PLATE FEMALE ELBOW



CHARACTERISTICS

BODY	PPSU
SLEEVE	Stainless Steel
O-RING	EPDM
PRESS PROFILE	U
STANDARDS	EN ISO 21003
COMPATIBLE SYSTEMS	HELIKLIMA KLIMAPRESS PPSU Fittings KLIMAPRESS Fittings Flanged Fittings

REFERENCE	DIAMETER (mm x in)	SMALL BOX (un)	LARGE BOX (un)
P-K212016	16x1/2"	15	90
P-K212020	20x1/2"	14	84
P-K212025	25x3/4"	10	60

TEE



CHARACTERISTICS

BODY	PPSU
SLEEVE	Stainless Steel
O-RING	EPDM
PRESS PROFILE	U
STANDARDS	EN ISO 21003
COMPATIBLE SYSTEMS	HELIKLIMA KLIMAPRESS PPSU Fittings KLIMAPRESS Fittings Flanged Fittings

REFERENCE	DIAMETER (mm x in)	SMALL BOX (un)	LARGE BOX (un)
P-K230016	16x16"	30	180
P-K230020	20x20"	18	108
P-K230025	25x25"	13	78
P-K230032	32x32"	6	36

REDUCED TEE



CHARACTERISTICS

BODY	PPSU
SLEEVE	Stainless Steel
O-RING	EPDM
PRESS PROFILE	U
STANDARDS	EN ISO 21003
COMPATIBLE SYSTEMS	HELIKLIMA KLIMAPRESS PPSU Fittings KLIMAPRESS Fittings Flanged Fittings

REFERENCE	DIAMETER	SMALL BOX	LARGE BOX
	(mm)	(un)	
P-K231020	20x16	20	120
P-K231026	25x20	13	78
P-K231033	32x25	8	48

FEMALE TEE



CHARACTERISTICS

BODY	PPSU
SLEEVE	Stainless Steel
O-RING	EPDM
PRESS PROFILE	U
STANDARDS	EN ISO 21003
COMPATIBLE SYSTEMS	HELIKLIMA KLIMAPRESS PPSU Fittings KLIMAPRESS Fittings Flanged Fittings

REFERENCE	DIAMETER	SMALL BOX	LARGE BOX
	(mm x in)	(un)	
P-K232016	16x1/2"	19	114
P-K232020	20x1/2"	14	84
P-K232026	25x1/2"	12	72
P-K232025	25x3/4"	8	48
P-K232033	32x3/4"	7	42
P-K232032	32x1"	4	24

MALE TEE



CHARACTERISTICS

BODY	PPSU
SLEEVE	Stainless Steel
O-RING	EPDM
PRESS PROFILE	U
STANDARDS	EN ISO 21003
COMPATIBLE SYSTEMS	HELIKLIMA KLIMAPRESS PPSU Fittings KLIMAPRESS Fittings Flanged Fittings

REFERENCE	DIAMETER (mm x in)	SMALL BOX (un)	LARGE BOX (un)
P-K233016	16x1/2"	26	156
P-K233020	20x1/2"	18	108
P-K233026	25x1/2"	14	84
P-K233025	25x3/4"	14	84

UNION



CHARACTERISTICS

BODY	PPSU
SLEEVE	Stainless Steel
O-RING	EPDM
PRESS PROFILE	U
STANDARDS	EN ISO 21003
COMPATIBLE SYSTEMS	HELIKLIMA KLIMAPRESS PPSU Fittings KLIMAPRESS Fittings Flanged Fittings

REFERENCE	DIAMETER (mm)	SMALL BOX (un)	LARGE BOX (un)
P-K200016	16x16	56	336
P-K200020	20x20	40	240
P-K200025	25x25	22	132
P-K200032	32x32	10	60

REDUCER UNION



CHARACTERISTICS

BODY	PPSU
SLEEVE	Stainless Steel
O-RING	EPDM
PRESS PROFILE	U
STANDARDS	EN ISO 21003
COMPATIBLE SYSTEMS	HELIKLIMA KLIMAPRESS PPSU Fittings KLIMAPRESS Fittings Flanged Fittings

REFERENCE	DIAMETER	SMALL BOX	LARGE BOX
	(mm)	(un)	
P-K238020	20x16	40	240
P-K238026	25x20	26	156
P-K238033	32x25	15	90

FEMALE UNION



CHARACTERISTICS

BODY	PPSU
SLEEVE	Stainless Steel
O-RING	EPDM
PRESS PROFILE	U
STANDARDS	EN ISO 21003
COMPATIBLE SYSTEMS	HELIKLIMA KLIMAPRESS PPSU Fittings KLIMAPRESS Fittings Flanged Fittings

REFERENCE	DIAMETER	SMALL BOX	LARGE BOX
	(mm x in)	(un)	
P-K234016	16x1/2"	30	180
P-K234020	20x1/2"	34	204
P-K234026	25x1/2"	25	150
P-K234025	25x3/4"	19	114
P-K234033	32x3/4"	18	108
P-K234032	32x1"	14	84

MALE UNION



CHARACTERISTICS

BODY	PPSU
SLEEVE	Stainless Steel
O-RING	EPDM
PRESS PROFILE	U
STANDARDS	EN ISO 21003
COMPATIBLE SYSTEMS	HELIKLIMA KLIMAPRESS PPSU Fittings KLIMAPRESS Fittings Flanged Fittings

REFERENCE	DIAMETER (mm x in)	SMALL BOX (un)	LARGE BOX (un)
P-K325016	16x1/2"	52	312
P-K325020	20x1/2"	42	252
P-K325026	25x1/2"	27	162
P-K325025	25x3/4"	27	162
P-K325033	32x3/4"	20	120
P-K325032	32x1"	15	90

LOOSE NUT UNION



CHARACTERISTICS

BODY	PPSU
SLEEVE	Stainless Steel
O-RING	EPDM
PRESS PROFILE	U
STANDARDS	EN ISO 21003
COMPATIBLE SYSTEMS	HELIKLIMA KLIMAPRESS PPSU Fittings KLIMAPRESS Fittings Flanged Fittings

REFERENCE	DIAMETER (mm x in)	SMALL BOX (un)	LARGE BOX (un)
P-K234017-L	16x3/4"	25	150
P-K234021-L	20x3/4"	20	120
P-K234025-L	25x3/4"	15	90
P-K234027-L	25x1"	10	60
P-K234032-L	32x1"	10	60
P-K234034-L	32x1 1/4"	5	30

KLIMAPRESS AND FLANGED FITTINGS

ELBOW 90°



CHARACTERISTICS

BODY	Brass CW617N
SLEEVE	Stainless Steel
O-RING	EPDM
PRESS PROFILE	ø 16-75 mm - U ø 75-110 mm - Flanged
STANDARDS	EN ISO 21003
COMPATIBLE SYSTEMS	HELIKIMA KLIMAPRESS PPSU Fittings KLIMAPRESS Fittings Flanged Fittings

REFERENCE	DIAMETER	SMALL BOX	LARGE BOX
	(mm)		(un)
K206016	16x16	32	256
K206018	18x18	22	176
K206020	20x20	22	176
K206025	25x25	11	88
K206032	32x32	8	64
K206040	40x40	1	40
K206050	50x50	1	26
K206063	63x63	1	10
K206075	75x75	1	6
Flanged Fittings			
K206075-I*	75x75	1	1
K206090-I*	90x90	1	1
K2060110-I*	110x110	1	1

FEMALE ELBOW



CHARACTERISTICS

BODY	Brass CW617N
SLEEVE	Stainless Steel
O-RING	EPDM
PRESS PROFILE	ø 16-75 mm - U ø 75-110 mm - Flanged
STANDARDS	EN ISO 21003 EN ISO 228 EN 10226
COMPATIBLE SYSTEMS	HELIKLIMA KLIMAPRESS PPSU Fittings KLIMAPRESS Fittings Flanged Fittings

REFERENCE	DIAMETER	SMALL BOX	LARGE BOX
	(mm x in)	(un)	
K208016	16x1/2"	30	240
K208017	16x3/4"	20	160
K208018	18x1/2"	22	176
K208019	18x3/4"	20	160
K208020	20x1/2"	25	200
K208021	20x3/4"	20	160
K208026	25x1/2"	16	128
K208025	25x3/4"	15	120
K208027	25x1"	10	80
K208033	32x3/4"	12	96
K208032	32x1"	8	64
K208040	40x1"	1	52
K208041	40x1 1/4"	1	50
K208042	40x1 1/2"	1	30
K208050	50x1"	1	30
K208051	50x1 1/2"	1	30
K208063	63x2"	1	10
K208075	75x2 1/2"	1	10
Flanged Fittings			
K208075-I*	75x2 1/2"	1	1
K208090-I*	90x3"	1	1
K2080110-I*	110x4"	1	1

MALE ELBOW



CHARACTERISTICS

BODY	Brass CW617N
SLEEVE	Stainless Steel
O-RING	EPDM
PRESS PROFILE	ø 16-75 mm - U ø 75-110 mm - Flanged
STANDARDS	EN ISO 21003 EN ISO 228 EN 10226
COMPATIBLE SYSTEMS	HELIKLIMA KLIMAPRESS PPSU Fittings KLIMAPRESS Fittings Flanged Fittings

REFERENCE	DIAMETER	SMALL BOX	LARGE BOX
	(mm x in)		(un)
K209016	16x1/2"	30	240
K209018	18x1/2"	20	160
K209020	20x1/2"	20	160
K209026	25x1/2"	15	120
K209025	25x3/4"	15	120
K209032	32x1"	8	64
Flanged Fittings			
K209075-I*	75x2 1/2"	1	1
K209090-I*	90x3"	1	1

WALL PLATE FEMALE ELBOW



CHARACTERISTICS

BODY	Brass CW617N
SLEEVE	Stainless Steel
O-RING	EPDM
PRESS PROFILE	U
STANDARDS	EN ISO 21003 EN ISO 228 EN 10226
COMPATIBLE SYSTEMS	HELIKLIMA KLIMAPRESS PPSU Fittings KLIMAPRESS Fittings Flanged Fittings

REFERENCE	DIAMETER	SMALL BOX	LARGE BOX
	(mm x in)	(un)	
K212016	16x1/2"	15	120
K212018	18x1/2"	12	96
K212020	20x1/2"	14	112
K212025	25x3/4"	10	80

TEE



CHARACTERISTICS

BODY	Brass CW617N
SLEEVE	Stainless Steel
O-RING	EPDM
PRESS PROFILE	ø 16-75 mm - U ø 75-110 mm - Flanged
STANDARDS	EN ISO 21003
COMPATIBLE SYSTEMS	HELIKLIMA KLIMAPRESS PPSU Fittings KLIMAPRESS Fittings Flanged Fittings

REFERENCE	DIAMETER	SMALL BOX	LARGE BOX
	(mm)	(un)	
K230016	16x16x16	20	160
K230018	18x18x18	14	112
K230020	20x20x20	14	112
K230025	25x25x25	8	64
K230032	32x32x32	4	32
K230040	40x40x40	1	25
K230050	50x50x50	1	15
K230063	63x63x63	1	6
K230075	75x75x75	1	5
Flanged Fittings			
K230075-I*	75x75x75	1	1
K230090-I*	90x90x90	1	1
K2300110-I*	110x110x110	1	1

REDUCED TEE



CHARACTERISTICS

BODY	Brass CW617N
SLEEVE	Stainless Steel
O-RING	EPDM
PRESS PROFILE	U
STANDARDS	EN ISO 21003
COMPATIBLE SYSTEMS	HELIKLIMA KLIMAPRESS PPSU Fittings KLIMAPRESS Fittings Flanged Fittings

REFERENCE	DIAMETER	SMALL BOX	LARGE BOX
	(mm)	(un)	
K231018	16x20x16	18	144
K231016	16x25x16	10	80
K231014	18x16x16	20	160
K231015	18x16x18	18	144
K231017	20x16x16	20	160
K231020	20x16x20	18	144
K231019	20x18x20	14	112
K231021	20x20x16	18	144
K231022	20x25x20	10	80
K231024	25x16x16	12	96
K231039	25x16x18	10	80
K231029	25x16x20	10	80
K231025	25x16x25	10	80
K231034	25x18x25	8	64
K231023	25x20x16	12	96
K231027	25x20x20	10	80

CONTINUED >

REFERENCE	DIAMETER	SMALL BOX	LARGE BOX
	(mm)	(un)	
K231026	25x20x25	8	64
K231038	25x25x18	7	56
K231028	25x25x20	7	56
K231031	25x32x25	7	56
K231030	32x16x32	8	64
K231037	32x18x32	5	40
K231032	32x20x32	7	56
K231035	32x25x25	6	48
K231033	32x25x32	6	48
K231042	40x25x40	1	28
K231043	40x32x40	1	28
K231053	50x32x50	1	21
K231055	50x40x50	1	18
K231064	63x40x63	1	10
K231065	63x50x63	1	8
K231076	75x63x75	1	6

FEMALE TEE



CHARACTERISTICS

BODY	Brass CW617N
SLEEVE	Stainless Steel
O-RING	EPDM
PRESS PROFILE	∅ 16-75 mm - U ∅ 75-110 mm - Flanged
STANDARDS	EN ISO 21003 EN ISO 228 EN 10226
COMPATIBLE SYSTEMS	HELIKLIMA KLIMAPRESS PPSU Fittings KLIMAPRESS Fittings Flanged Fittings

REFERENCE	DIAMETER	SMALL BOX	LARGE BOX
	(mm x in x mm)		(un)
K232016	16x1/2"x16	16	128
K232018	18x1/2"x18	16	128
K232020	20x1/2"x20	15	120
K232026	25x1/2"x25	10	80
K232025	25x3/4"x25	8	64
K232032	32x1"x32	4	32
K232040	40x1"x40	1	32
K232041	40x1 1/4"x40	1	18
K232050	50x1"x50	1	18
K232051	50x1 1/2"x50	1	18
K232063	63x1"x63	1	10
K232065	63x2"x63	1	10
K232064	63x2 1/2"x63	1	6
K232075	75x2 1/2"x75	1	5
Flanged Fittings			
K232075-I*	75x2 1/2"x75	1	1
K232090-I*	90x3"x90	1	1
K2320110-I*	110x4"x110	1	1

MALE TEE



CHARACTERISTICS

BODY	Brass CW617N
SLEEVE	Stainless Steel
O-RING	EPDM
PRESS PROFILE	U
STANDARDS	EN ISO 21003 EN ISO 228 EN 10226
COMPATIBLE SYSTEMS	HELIKLIMA KLIMAPRESS PPSU Fittings KLIMAPRESS Fittings Flanged Fittings

REFERENCE	DIAMETER	SMALL BOX	LARGE BOX
	(mm x in x mm)		(un)
K233016	16x1/2"x16	16	128
K233018	18x1/2"x18	12	120
K233020	20x1/2"x20	15	120
K233026	25x1/2"x25	5	40
K233025	25x3/4"x25	5	40
K233032	32x1"x32	4	32

UNION



CHARACTERISTICS

BODY	Brass CW617N
SLEEVE	Stainless Steel
O-RING	EPDM
PRESS PROFILE	ø 16-75 mm - U ø 75-110 mm - Flanged
STANDARDS	EN ISO 21003
COMPATIBLE SYSTEMS	HELIKLIMA KLIMAPRESS PPSU Fittings KLIMAPRESS Fittings Flanged Fittings

REFERENCE	DIAMETER	SMALL BOX	LARGE BOX
	(mm)		(un)
K200016	16	45	360
K200018	18	30	240
K200020	20	36	288
K200025	25	20	160
K200032	32	12	96
K200040	40	1	60
K200050	50	1	36
K200063	63	1	15
K200075	75	1	12
Flanged Fittings			
K200075-I*	75	1	4
K200090-I*	90	1	2
K2000110-I*	110	1	1

REDUCER UNION



CHARACTERISTICS

BODY	Brass CW617N
SLEEVE	Stainless Steel
O-RING	EPDM
PRESS PROFILE	U
STANDARDS	EN ISO 21003
COMPATIBLE SYSTEMS	HELIKLIMA KLIMAPRESS PPSU Fittings KLIMAPRESS Fittings Flanged Fittings

REFERENCE	DIAMETER	SMALL BOX	LARGE BOX
	(mm)		(un)
K238018	18x16	37	296
K238020	20x16	37	296
K238021	20x18	37	296
K238025	25x16	20	160
K238027	25x18	20	160
K238026	25x20	20	160
K238032	32x20	15	120
K238033	32x25	12	96
K238042	40x25	1	72
K238043	40x32	1	60
K238052	50x25	1	65
K238053	50x32	1	50
K238054	50x40	1	42
K238064	63x40	1	20
K238065	63x50	1	20
K238076	75x63	1	13

FEMALE UNION



CHARACTERISTICS

BODY	Brass CW617N
SLEEVE	Stainless Steel
O-RING	EPDM
PRESS PROFILE	∅ 16-75 mm - U ∅ 75-110 mm - Flanged
STANDARDS	EN ISO 21003 EN ISO 228 EN 10226
COMPATIBLE SYSTEMS	HELIKLIMA KLIMAPRESS PPSU Fittings KLIMAPRESS Fittings Flanged Fittings

REFERENCE	DIAMETER	SMALL BOX	LARGE BOX
	(mm x in)	(un)	
K234016	16x1/2"	40	320
K234018	18x1/2"	35	280
K234019	18x3/4"	30	240
K234020	20x1/2"	40	320
K234021	20x3/4"	30	240
K234026	25x1/2"	20	160
K234025	25x3/4"	20	160
K234027	25x1"	18	144
K234033	32x3/4"	18	144
K234032	32x1"	18	144
K234040	40x1 1/4"	1	84
K234051	50x1 1/4"	1	50
K234050	50x1 1/2"	1	48
K234063	63x2"	1	20
K234075	75x2 1/2"	1	16
Flanged Fittings			
K234075-I*	75x2 1/2"	1	4
K234090-I*	90x3"	1	2
K2340110-I*	110x4"	1	2

MALE UNION



CHARACTERISTICS

BODY	Brass CW617N
SLEEVE	Stainless Steel
O-RING	EPDM
PRESS PROFILE	∅ 16-75 mm - U ∅ 75-110 mm - Flanged
STANDARDS	EN ISO 21003 EN ISO 228 EN 10226
COMPATIBLE SYSTEMS	HELIKLIMA KLIMAPRESS PPSU Fittings KLIMAPRESS Fittings Flanged Fittings

REFERENCE	DIAMETER	SMALL BOX	LARGE BOX
	(mm x in)	(un)	
K325016	16x1/2"	50	400
K325018	18x1/2"	40	320
K325019	18x3/4"	35	336
K325020	20x1/2"	40	320
K325021	20x3/4"	35	280
K325026	25x1/2"	20	160
K325025	25x3/4"	18	144
K325027	25x1"	16	128
K325033	32x3/4"	12	96
K325032	32x1"	12	96
K325040	40x1 1/4"	1	64
K325050	50x1 1/2"	1	45
K325063	63x2"	1	20
K325075	75x2 1/2"	1	14
Flanged Fittings			
K325075-I*	75x2 1/2"	1	4
K325090-I*	90x3"	1	2
K3250110-I*	110x4"	1	2

LOOSE NUT UNION



CHARACTERISTICS

BODY	Brass CW617N
SLEEVE	Stainless Steel
O-RING	EPDM
PRESS PROFILE	U
STANDARDS	EN ISO 21003 EN ISO 228 EN 10226
COMPATIBLE SYSTEMS	HELIKLIMA KLIMAPRESS PPSU Fittings KLIMAPRESS Fittings Flanged Fittings

REFERENCE	DIAMETER	SMALL BOX	LARGE BOX
	(mm x in)		(un)
K234016-L	16x1/2"	40	320
K234018-L	18x1/2"	40	320
K234020-L	20x1/2"	40	320
K234021-L	20x3/4"	30	240
K234025-L	25x3/4"	18	144
K234032-L	32x1"	14	112

STOP VALVE (BODY)



CHARACTERISTICS

BODY	Brass CW617N
SLEEVE	Stainless Steel
O-RING	EPDM
PRESS PROFILE	U
STANDARDS	EN ISO 21003 EN ISO 228 EN 10226
COMPATIBLE SYSTEMS	HELIKLIMA KLIMAPRESS PPSU Fittings KLIMAPRESS Fittings Flanged Fittings

REFERENCE	DIAMETER	SMALL BOX	LARGE BOX
	(mm)		(un)
K244016-C	16	10	80
K244018-C	18	5	40
K244020-C	20	10	80
K244025-C	25	8	64
K244032-C	32	6	48

STOP VALVE



CHARACTERISTICS

BODY	Brass CW617N
SLEEVE	Stainless Steel
O-RING	EPDM
PRESS PROFILE	U
STANDARDS	EN ISO 21003 EN ISO 228 EN 10226
COMPATIBLE SYSTEMS	HELIKLIMA KLIMAPRESS PPSU Fittings KLIMAPRESS Fittings Flanged Fittings

REFERENCE	DIAMETER	SMALL BOX	LARGE BOX
	(mm)		(un)
K244016	16	5	40
K244018	18	5	40
K244020	20	5	40
K244025	25	5	40
K244032	32	4	32

CHROMED UPPER PART



CHARACTERISTICS

UPPER PART	Chrome-Plated Brass
MIRROR	Chrome-Plated Stainless Steel
COMPATIBLE FITTINGS	Stop Valve

REFERENCE	DIAMETER	SMALL BOX	LARGE BOX
	(mm)	(un)	
K1632-RO	16-32	5	40

HANDLE MECHANISM



CHARACTERISTICS

UPPER PART	Chrome-Plated Brass
MIRROR	Chrome-Plated Stainless Steel
COMPATIBLE FITTINGS	Stop Valve

REFERENCE	DIAMETER	SMALL BOX	LARGE BOX
	(mm)	(un)	
K1632-CP	16-32	5	40

VALVE KIT EXTENDER



CHARACTERISTICS

RAW MATERIAL Brass CW617N
 COMPATIBLE FITTINGS Stop Valve

REFERENCE	DIAMETER (mm)	SMALL BOX (un)	LARGE BOX (un)
K1632-25	25	1	80

DISTRIBUTOR



CHARACTERISTICS

BODY Brass CW617N
 SLEEVE Stainless Steel
 O-RING EPDM
 PRESS PROFILE U
 STANDARDS EN ISO 21003 | EN ISO 228 | EN 10226
 COMPATIBLE SYSTEMS HELIKLIMA | KLIMAPRESS PPSU Fittings
 KLIMAPRESS Fittings | Flanged Fittings

REFERENCE	DIAMETER (mm)	SMALL BOX (un)	LARGE BOX (un)
K2520161616	25x20x16x16x16	3	24
K2520201616	25x20x20x16x16	3	24



MULTILAYER TOOLS

PRESS MACHINE



REFERENCE	BOX
	(un)
PRESS-ELECTREMS	1
PRESS-ELECTREMSACC	1
PRESS-BATREMS	1

SHEAR KAPITAL



REFERENCE	DIAMETER	BOX
	(mm)	(un)
KC35	16-35	1

SHEAR RIDGID



REFERENCE	DIAMETER	BOX
	(mm)	(un)
TES 32/R	16-32	1

PRESS HEAD U / RF



REFERENCE	DIAMETER	PROFILE	BOX
	(mm)		(un)
MORD-16 MK	16	U	1
MORD-18 MK	18	U	1
MORD-20 MK	20	U	1
MORD-25 MK	25	U	1
MORD-32 MK	32	U	1
MORD-40 MK	40	U	1
MORD-50 MK	50	U	1
MORD-63 MK	63	U	1
MORD-75 MK	75	U	1
MORD/RF-16 PEX	16	RF	1
MORD/RF-20 PEX	20	RF	1
MORD/RF-25 PEX	25	RF	1
MORD/RF-32 PEX	32	RF	1

CALIBRATOR



REFERENCE	DIAMETER	BOX
	(mm)	(un)
CALIBRAES-S32	16/20/25/32	1
CALIBRAES-S63	40/50/63	1
CALIBRAES-CA75	75	1



PE-Xa

4

PE-Xa PIPES - PEXROMA

- PE-Xa | PE-Xa EVOH

INSTALLATION GUIDELINES

PIPE GENERAL ADVANTAGES

CERTIFICATIONS

PRODUCT RANGE

- PE-Xa pipe
- PE-Xa EVOH pipe

PE-Xa PIPES - PEXROMA

PE-Xa | PE-Xa EVOH



CHARACTERISTICS



HEATING SYSTEMS



APPROVED FOR DRINKING WATER



DISINFECTION RESISTANT



LEGIONELLA CONTROL



100% RECYCLABLE



ECO-FRIENDLY

PIPE CLASSIFICATION

SDR Standard dimension ratio – ratio between pipe's outside diameter and it's wall thickness

$$SDR = \frac{d_e}{e}$$

S Series - dimensionless index, which is used for the calculation of the wall thickness of the pipe.

$$S = \frac{d_e - e}{2e}$$

d_e Outside diameter of the pipe

e Wall thickness of the pipe

MATERIAL

PE-Xa Crosslinked High Density Polyethylene

EVOH Oxygen Barrier

PRODUCT RANGE OVERVIEW

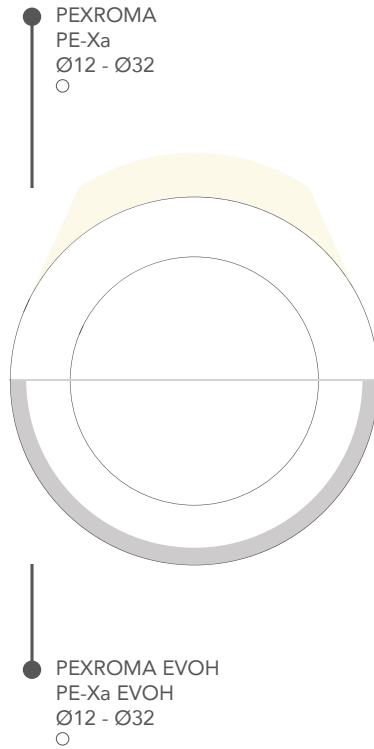

PE-Xa PIPES							
DIAMETERS (mm)	12	16	17	18	20	25	32
PEXROMA PE-Xa PIPE	✓	✓	✓	✓	✓	✓	✓
PEXROMA EVOH PE-Xa EVOH PIPE	✓	✓	✓	✓	✓	✓	✓

Notes: standard colour: natural. Other colours or dimensions available on demand.

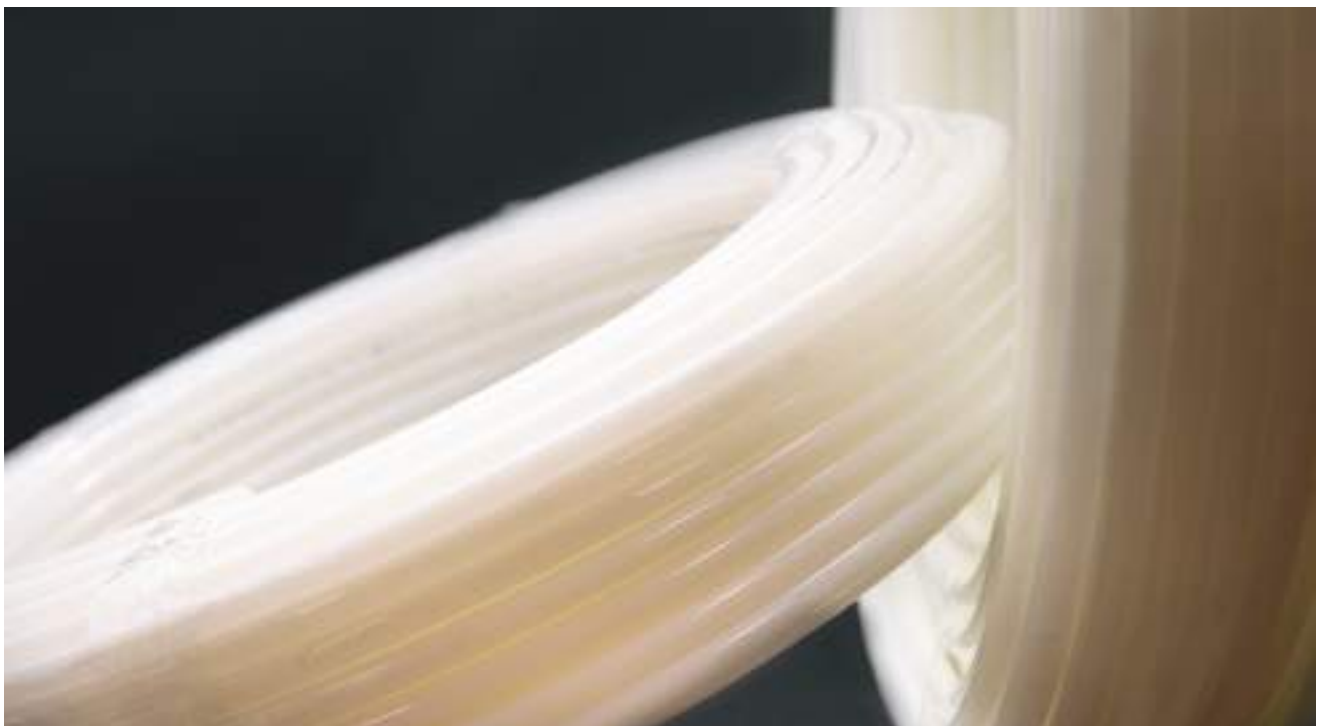

PEXROMA PIPE

PEXROMA: PE-Xa PIPE

PEXROMA crosslinked high-density polyethylene pipe is produced by IR/Peroxide method. This method ensures an even and very high degree of crosslinking over the entire cross-section of thick-wall pipes.

Crosslinking is a process which transforms the chemical structure in such a way that the polymer chains are linked within themselves into a three-dimensional network through chemical connections. The result is a flexible thermoset polymer with improved mechanical, thermal and chemical properties. The crosslinked polymeric structure makes dissolution impossible, unless its structure is previously destroyed.

The properties of PE-Xa make the pipe the most flexible in the market while offering better resistance to stress than other PE-X pipes, produced with different methods.

There are three methods of PE-X manufacturing:

- PE-Xa made with a peroxide method, requires a minimum of 70% crosslinked polyethylene
- PE-Xb made with a silane method, requires a minimum of 65% crosslinked polyethylene.
- PE-Xc made with a radiation method, requires a minimum of 60% crosslinked polyethylene.

PEXROMA is PE-Xa, which provides the highest, most consistent level of crosslinking. This technology enhances flexibility and thermal memory compared to PE-Xb and PE-Xc.

PE-Xa pipe provides easy handling and kink repair, avoiding the risk of bottlenecks which would reduce the flow, thus optimizing installation times.

PEXROMA can be supplied in a monolayer without oxygen barrier PE-Xa or a multilayer pipe with oxygen barrier PE-Xa w/EVOH.

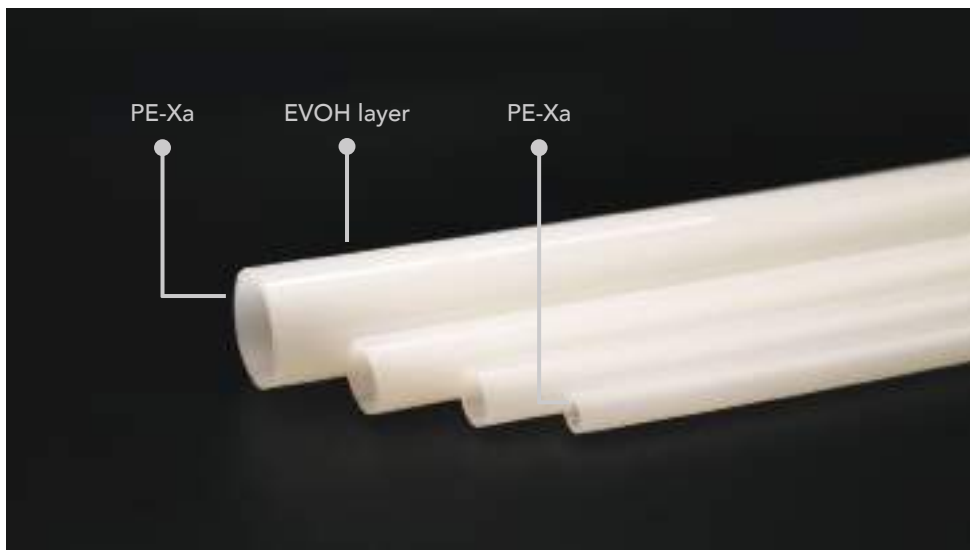

IR/PEROXIDE CROSSLINKED METHOD

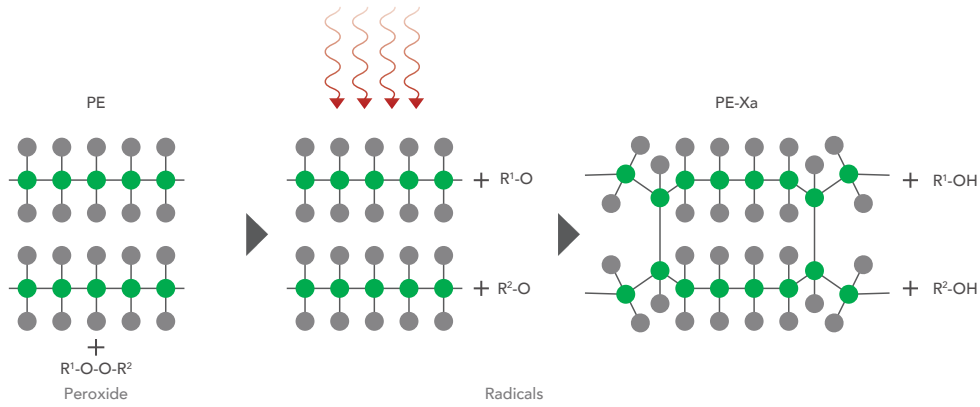

- Atoms of Hydrogen
- Atoms of Carbon

EXPECTED STRENGTH OF PE-X ACCORDING TO ISO 15875

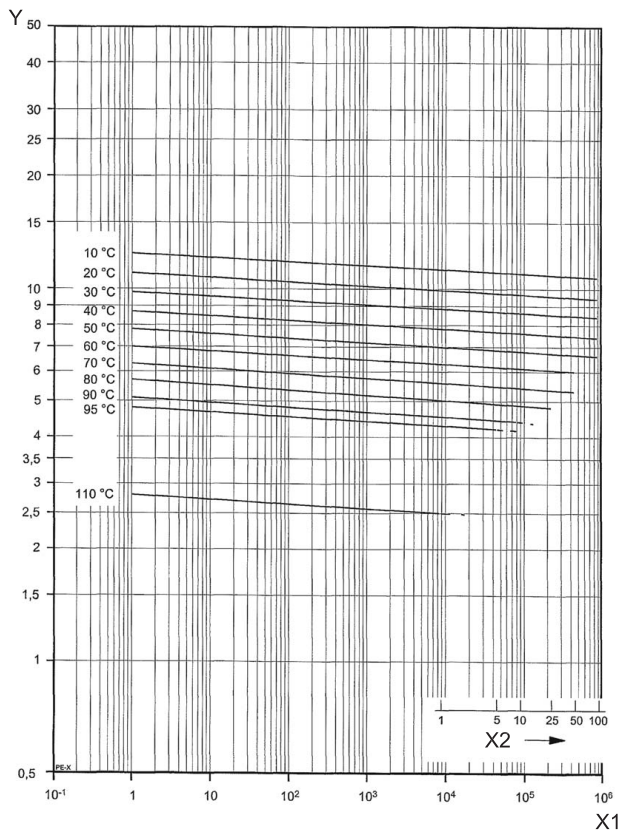

KEY

- X1 Time, t1, to fracture, in hours
- X2 Time, t2, to fracture, in years
- Y Hoop stress, σ , in megapascal

OXYGEN BARRIER

The Oxygen Barrier is provided by an ethylene vinyl alcohol – EVOH layer prevents oxygen permeability in the system which reduces corrosion within the system, thus reducing premature failing of system components.

The EVOH layer provides excellent functional barrier against organic solvents and gases. With its exceptional elasticity it protects the product integrity. The Oxygen Barrier seals the oxygen access, therefore increasing the installation life expectancy. In a multilayer pipe, all layers are connected permanently via adhesive.



PE-Xa w/EVOH is built on a 3-layer structure, the PE-Xa internal layer, a special bonding agent in the middle layer and a final EVOH external layer. The pipe fulfils all requirements for the oxygen diffusion resistance according applicable standards.

In sanitary water systems, because water is already oxygenated to saturation point, no diffusion takes place. Nevertheless, in heating systems the established requirements for resistance to diffusion, make PEXROMA w/EVOH the ideal solution.

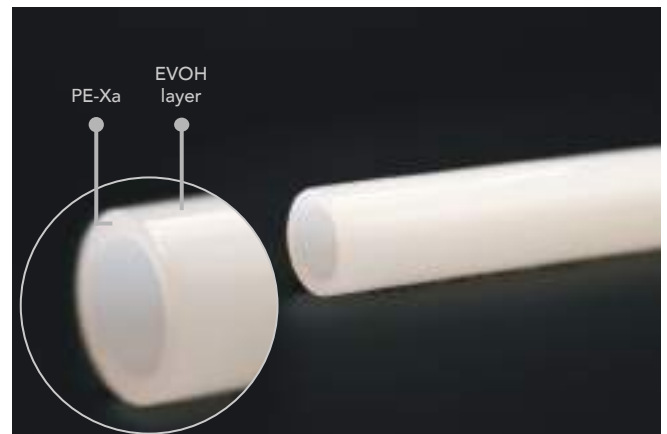

EVOH PROPERTIES

PARAMETER	VALUE	STANDARD
OTR - 20°C, 0% RH	0,2 cm ³ .20µm/m ² .day.atm	ASTM D3985
OTR - 20°C, 65% RH	0,4 cm ³ .20µm/m ² .day.atm	ASTM D3985
OTR - 20°C, 85% RH	1,5 cm ³ .20µm/m ² .day.atm	ASTM D3985
OTR - 20°C, 100% RH	1,9 cm ³ .20µm/m ² .day.atm	ASTM D3985

OTR – Oxygen Transmission Rate

PE-Xa: RAW MATERIAL AND PIPE PROPERTIES

PARAMETER	VALUE	STANDARD
PHYSICAL		
Density	953 kg/m ³	ISO 1183
MFI - 190°C/2.16 kg	15 g/10min	ISO 1133
MFI - 190°C/5.00 kg	0,7 g/10min	ISO 1133
Roughness	0,007 mm	ISO 5436
Moisture Absorption (22°C)	0,01 mg/4 day	ISO 62
MECHANICAL		
Tensile Modulus (23°C)	1100 MPa	ISO 527
Tensile Stress At Yield (23°C)	28 MPa	ISO 527
Tensile Strain Yield (23°C)	8%	ISO 527
Tensile Stress At Break	37 MPa	ISO 527
Maximum Laying Temperature	50°C	
Minimum Laying Temperature	-20°C	
Pipe Constant	12	
THERMAL		
Vicat Softening Temperature A50	130°C	ISO 306
Vicat Softening Temperature B50	79°C	ISO 306
Specific Heat	2,3 kJ/kg°C	
Thermal Conductivity	0,35 W/m K	DIN 52612
Thermal Expansion Coefficient	1,4x10 ⁻⁴ m/m °C	VDE 0304
Linear Coefficient	0,026 mm/m K	
Fire Classification	B2	DIN 4102
HARDNESS		
Shore Hardness (Shore D)	64	ISO 868
Ball Indentation Hardness	49 MPa	ISO 2039
ELECTRICAL		
Specific Resistance	10 ¹⁵ W.m	
Dielectric Constant	2,3	
Dielectric Loss Factor (20°C/50hz)	1x10 ⁻³	
GENERAL		
Smallest Bend Radius	5 x d _e mm	DIN 4721
Polyethylene Crosslinking Method	IR/Peroxide	
Degree Of Crosslinking	≥70%	EN ISO 15875

ADVANTAGES AND KEY FEATURES OF PEXROMA



THERMAL AND ELASTIC MEMORY



DRINKABLE WATER APPLICATIONS



HIGH DEGREE OF CROSS-LINKING



HIGH RESISTANCE TO TEMPERATURE AND PRESSURE



HIGH CHEMICAL RESISTANCE



OXYGEN DIFFUSION BARRIER



HIGH RESISTANCE TO STRESS CRACKING



EXCELLENT FLEXIBILITY



CORROSION RESISTANCE



LIGHTWEIGHT



HIGH ABRASION RESISTANCE



LOW NOISE



HIGHLY SMOOTH SURFACE



SUPPLIED IN COILS



PREVENTS LIMESCALE



ECO-FRIENDLY



KINKING RESISTANCE



NATIONAL AND INTERNATIONAL CERTIFICATIONS

NEW

MONOLAYER COLOURED



Together with the top rated suppliers, HELIROMA developed a monolayer PE-Xa pipe fully coloured, available on blue and red.

APPLICATIONS

The PEXROMA has a wide range of applications, as well as working pressures and temperatures such as: new installations, repairs, renovations and prefabricate installations.

This system is suitable for applications including: drinking water installations, sanitary systems, hot and cold water distribution, heating and cooling systems, community systems, industrial applications. In specific applications, HELIROMA should be consulted.

In heating systems applications PEXROMA w/EVOH must be applied.

The EN ISO 15875 PE-X defines four classes of application, with a specific combination of working pressure and temperature. In the table below it is shown the working pressure and temperature for PE-Xa pipes, according to their series.

APPLICATION CLASS		P _D (bar)					
		PEXROMA & PEXROMA EVOH					
SERIES		2,5	3,2	3,5	4,0	4,5	5,0
1	Hot water supply 60°C	10	10	10	8	8	6
2	Hot water supply 70°C	10	10	10	8	6	6
4	Underfloor heating and low temperature radiators	10	10	10	10	8	8
5	High-temperature radiators connection	10	10	8	8	6	6

PIPE MARKING

The following sequence must be printed once per meter in all pipes.

Example:

HR HELIROMA PEXROMA UNE-EN ISO 15875-2 AENOR 001/621 Certif PE-Xa DIAM 20 x 2,0 mm - C CLASSE 1/8 2/6 4/8 5/6 bar L DD/MM/YY HH:MM OP-3/01 Made in Portugal

MARKED SYMBOL	DESCRIPTION
HR Heliroma	Manufacturer's name
PEXROMA	Product trade mark
EN ISO 15875-2	Product Regulations
AENOR, Certif	Certificates, Approvals
PE-Xa	Material
d _e x e	Nominal outside diameter x Nominal wall thickness
C	Pipe dimension class (according EN ISO 15875)
1/8 2/6 4/8 5/6 bar	Application class combined with operating pressure
L	Machine number
DD/MM/YY HH:MM	Date of manufacture
OP-3/01	Production order number
Made in Portugal	Additional information

DIMENSIONS AND FLOW RATE

PIPE	DN	Wall Thickness (mm)	Speed (m/s)	Flow Capacity		
				m ³ /h	L/s	L/h
PEXROMA AND PEXROMA EVOH	12	2,0	2	0,362	0,101	362
	16	1,8		0,869	0,242	869
	16	2,0		0,814	0,226	814
	16	2,2		0,761	0,211	761
	17	2,0		0,956	0,265	956
	18	2,0		1,108	0,308	1108
	20	1,9		1,484	0,412	1484
	20	2,0		1,448	0,402	1448
	20	2,8		1,173	0,326	1173
	25	2,3		2,353	0,654	2353
	25	3,5		1,832	0,509	1832
	32	2,9		3,882	1,078	3882
	32	4,4		3,044	0,845	3044



INSTALLATION GUIDELINES

GENERAL RECOMMENDATIONS

Before starting to work with HELIROMA's products it is very important to read the technical catalogue:

- HELIROMA's systems have to be assembled according to HELIROMA's instructions;
- For applications or conditions not mentioned, make sure to obtain HELIROMA's technical approval;
- All regulations and directives have to be fulfilled on designing and installation phases;
- Product warranty is valid only for HELIROMA's products.

DESIGNING GUIDELINES

The design and layout of the building hot and cold water distribution system shall comply with accepted plumbing engineering practices and as local requirements.

Always consider the shrinking in length of the PEXROMA pipes when planning the installation. Permitted shrinking in lengths as per standards for PE-X pipes EN ISO 15875 is 3 % maximum.

The pressure loss in the PE-Xa system depends on the flow rate, water temperatures and fluid properties.

The linear pressure loss through pipe friction is the product of the pipe friction pressure gradient – R and the pipe length – L. R depends on the volumetric flow rate, inner diameter, piping material and temperature. HELIROMA advises a maximum flow rate of 2.0 m/s.

Compliance with local regulations is mandatory and responsibility of the installer.

Pressure Loss Tables, please refer to Annex C.

In case of concealed installations, use PE-Xa pipe in conduits to reduce the risk of water damages and allow for flexible media pipe to be replaced. The conduits dimension should fulfil all local requirements.



THERMAL EXPANSION

Due to laws of physics, all piping materials expand when heated and contract when cooled.

When thermal expansion is anticipated, pipe movement should be controlled to prevent changes that could damage the piping system.

PEXROMA has great linear expansion and small expansive forces compared to metal pipes. With concealed installation, linear expansion takes place between pipe and conduit. On wall mounted installations, the expansive forces are transferred to expansion absorbing devices (previously planned) or to the building structure through fixing points.

The linear expansion of the pipe is calculated according to the following formula and can be taken from the table on Annex A.

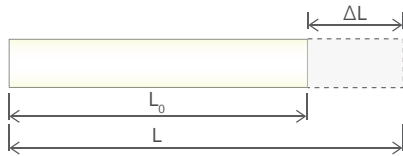

THERMAL EXPANSION FORMULA

$$\Delta L = L - L_0 = L_0 \times \alpha \times \Delta T$$

ΔL Linear expansion (L-L₀) (mm)

L Final length of the pipe, at T temperature (m)

L₀ Initial length of the pipe, at T₀ temperature (m)

α Linear expansion coefficient: $\alpha = 0,026 \text{ mm/m}^\circ\text{C}$

ΔT Variation of pipe temperature, in °C (T-T₀)

BENDING

PEXROMA pipe may be bent with specific bending tools or by hand. The minimum recommended radius is $8 \times d_e$ or $5 \times d_e$ with hot bending (read the chapter KINKED PIPES). The minimum bending radius cannot be less than those specified for each producer, according to pipe characteristics.

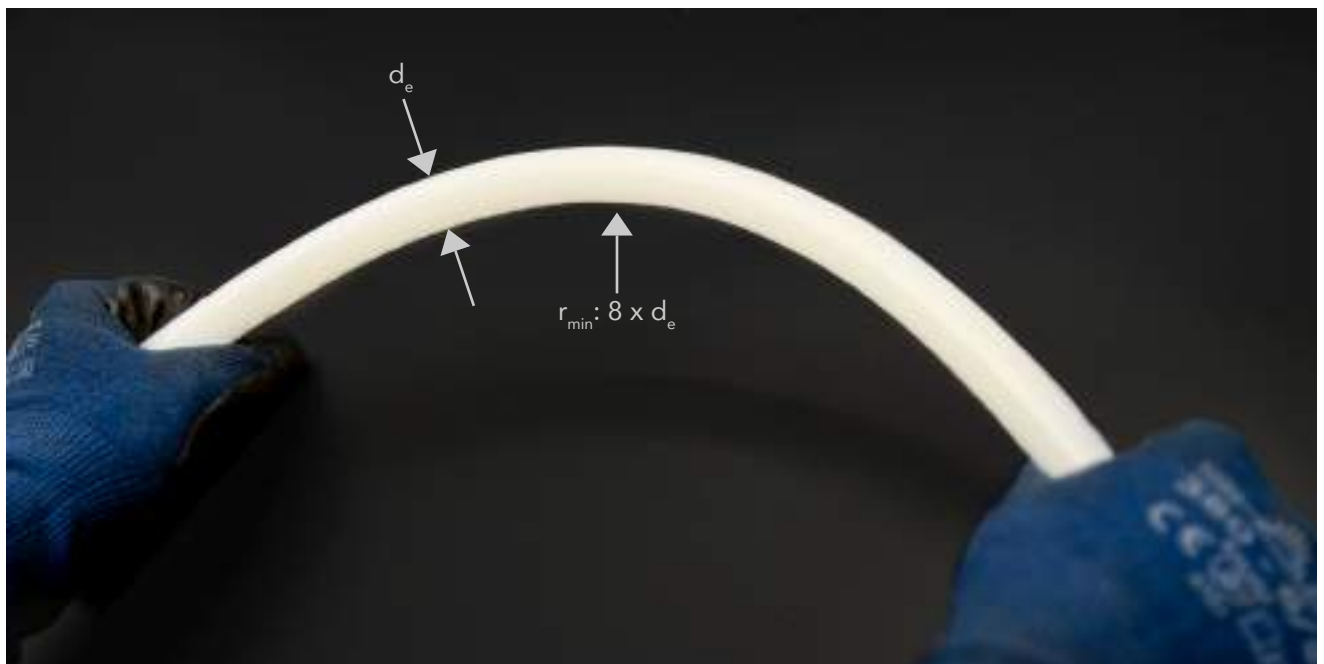

KINKED PIPES

In case of accidentally kinking the pipe during installation, the pipe can be carefully heated returning to its original shape due to thermal memory.

Always use caution when operating a heat blower and **never use an open flame** to heat the pipe. The heating must be made in a rotating fashion around the pipe to evenly heat the surface.

When fully heated, the pipe will become transparent, returning to its original shape, then remove the heat source and allow the pipe to reach room temperature. If heating has discoloured the pipe, this indicates that the material has been damaged and the pipe needs to be replaced.

Once cooled, the pipe will return to its original appearance and regain all of its strength, while reducing its flexibility.

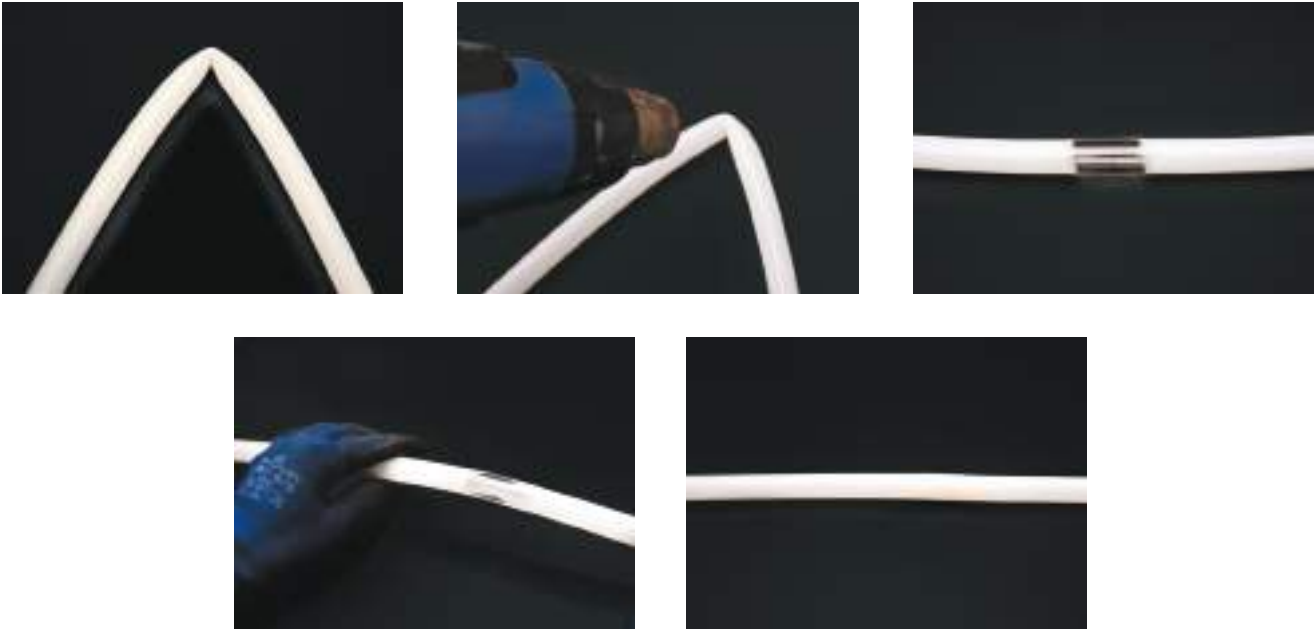

- Do not use open flame for heating;
- Avoid overheating;
- Do not heat PEXROMA with EVOH. It has an outside layer of oxygen barrier which if heated can be damaged.



CAUTION
INCORRECT BENDING



CORROSION

PEXROMA pipe is produced with a chemical non-reactive raw material, contributing to an excellent corrosion resistance, thus avoiding wall degradation even at high water velocity. The exceptional corrosion resistance, according to ASTM classification, inhibits scale built-up, very common with metal pipes. The high resistance to corrosion allows PE-Xa pipes to be used for various applications, even industrial ones.

INSULATION

The thermal insulation of pipelines should be taken into consideration to: situation where condensation may occur, protect the cold-water pipes against exposure to heat, minimize heat losses, absorb the variations in length caused by temperature, reduce the transfer of heat to the structures around, reduce the sound transmission, protect against corrosion and protect against mechanical stress.

PE-Xa pipe has a lower thermal conductivity than copper and metallic pipes resulting in less heat loss through the surface and less prone to condensation.

Condensation occurs when the temperature of a surface falls below the saturation temperature of the surrounding air. The saturation temperature of the air is determined from the current temperature and the humidity. The temperature of the surface is determined by the heat transfer from the material to the pipe surface, from the air to the pipe surface, and the heat transfer through the pipe's wall.

The insulation thickness depends on the required working conditions and specific national requirements and guidelines.



FREEZING

PEXROMA pipes should not be exposed to freezing temperatures, specially if the pipes are filled with water. The PE-Xa pipe can normally tolerate freezing, due to its flexibility, however, if the pipe is not allowed to expand it may burst resulting in leaks, micro crackers and operational failures. Repeated freezing weakens the pipe.

PIPE FEATURES

From the combination of quality materials and production technology used on manufacturing, PEXROMA results a remarkably clean water-distribution piping. Otherwise, the highly chemical resistance, that makes it is not affected by low pH water (acid waters) and withstand high temperature and pressure, that allows them application on the most demanding applications.

PEXROMA pipe has high resistance to the stress cracking, thus can withstand minor scratches without being weakened.

Thanks to the good elasticity of PE-Xa pipe, PEXROMA absorbs until up to 30% withstand vibrations.

PEXROMA pipe production is energetically efficient with low environmental impact.

HELIROMA always adopts ecological practices, considering environmental protection and save natural of sources.

Finally HELIROMA's PE-Xa pipe is available in several diameters and thicknesses, coil lengths, monolayer coloured and EVOH coloured. The pipes can be manufactured according to customer design and specifications.



CHEMICAL RESISTANCE

PE-Xa offers high resistance to chemical-dissolving agents. The unique molecular structure is stable and inert, and it is virtually unaffected by chemicals (organic or inorganic) commonly found in plumbing systems. Contact HELIROMA Technical Department for specific chemical compatibility verification.

LEAKAGE TEST

All HELIROMA products must be submitted to a leakage test. The product warranty is only valid if the leakage test has been performed, on the date the system has been installed.

Before the pressure test, it must be ensured that all components of the installation are freely accessible and visible, in order to identify unpressed or incorrectly installed fittings. Pressure test must be carried out before the system is put into operation and before they are insulated and sealed.

It is recommended to perform the pressure test with compressed air or inert gas if the pipeline system is to remain unfilled after a pressure test. When the pressure test is performed with water, despite draining the system, residual water can remain in some sections, this is an ideal environment for bacteria.

LEAK TEST WITH COMPRESSED AIR OR INERT GAS

A pressure test with compressed air or inert gases is carried out in two stages: leak test (checking the system for leaks. Unpressed and inadequately screwed connections can be identified in this way) and load test (checking the system for the quality of the material and installation process). Both stages must be performed under recognized engineering best practices.

Before the leakage test, all equipments, water heaters, fittings, or pressure valves or pressure vessels must be disconnected from the system. The air volume can affect safety and testing accuracy.

All lines must be directly sealed with material which can withstand the test pressure. Closed stop valves are not enough to a tight shut-off.

Before starting the test stages, it is important to wait for temperature equalisation and steady-state condition after pressure build-up.

For safety reasons, the test pressures are set to a maximum of 3 bar. The pressure should be gradually increased up to the required pressure. If a pressure drop occurs during the test period, there is a leak in the system, repeat the leak test.

Leak test – Stage 1

All pipe connections must be visually inspected, before starting the test.

The manometer used must have an accuracy of 1 mbar.

The test pressure is 150 mbar. For systems up to 100 litres volume, the test must run for, at least, 120 minutes. For bigger volume systems, The time must be extended 20 minutes per additional 100 litres.

During the test stages cannot occur any leakage.

Load Test – Stage 2

Following the leak test, the load test is carried out.

Pipe sizes $d_g \leq 63$ mm, for a system volume up to 100 litres, the pressure is increased to 3 bar maximum.

Pipe sizes $d_g > 63$ mm, for a system volume up to 100 litres, the pressure is increased to 1 bar maximum.

For a system volume of up to 100 litres, the test time must be at least 10 minutes.

The sealing of the system must be evident, and after that must be confirmed with a written record, that has to be signed by the installer, stating place and date and sent to HELIROMA technical department.

Please refer to the test protocol recommended in Annex D.

LEAK TEST WITH WATER

The pressure test checks the tightness of the pipe installation as well as the axial restraint of the connections.

All pipe connections must be visually inspected, before starting the test. The local regulations and/or standards must always be considered during the pressure test.

Before starting the test stages, it is important to wait for temperature equalisation and steady-state condition after pressure build-up.

If the pressure falls during the test period, there is a leak in the system, meaning that the leak test must be repeated.

There must be no drop in pressure and no visible indication of leakage.

The sealing of the system must be evident, and after that must be confirmed with a written record, that has to be signed by the installer, stating place and date and sent to HELIROMA technical department.

Please refer to the protocol recommended in Annex D.

TRANSPORT AND STORAGE

HELIROMA pipes can be stored outdoor or indoor but preferably in a covered area, protecting them from direct sunlight and low temperatures.

Pipes and fittings must not be exposed to direct UV-radiation, for long periods. This radiation has effects on the durability of all polymer plastics. Do not store permanently outdoor.

Despite the high quality and resistance of all HELIROMA products, they should be handled with caution. Do not drop the pipes when unloading them and protect them from falling object, or equipments. The process of loading, transport and subsequent unloading should be carried out making sure that pipes and fittings do not take any damage.

Pipes and fittings should be kept in their original packaging if at all possible until processed. Damaged, bent or deformed pipes must not be processed.

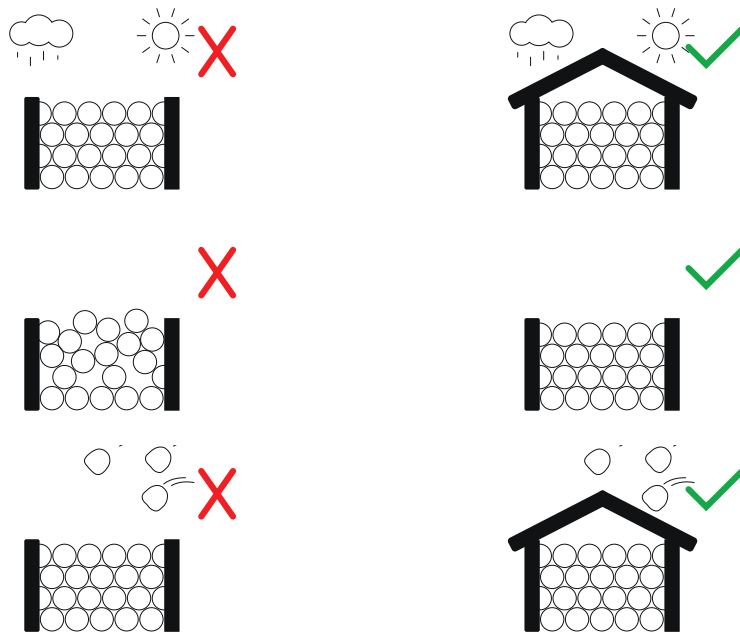

WARRANTY

All supplied products by HELIROMA installed according all procedures in HELIROMA catalogue, have 10 years warranty against manufacturing defects.

For further information, consult the general terms and conditions.



PIPE GENERAL ADVANTAGES

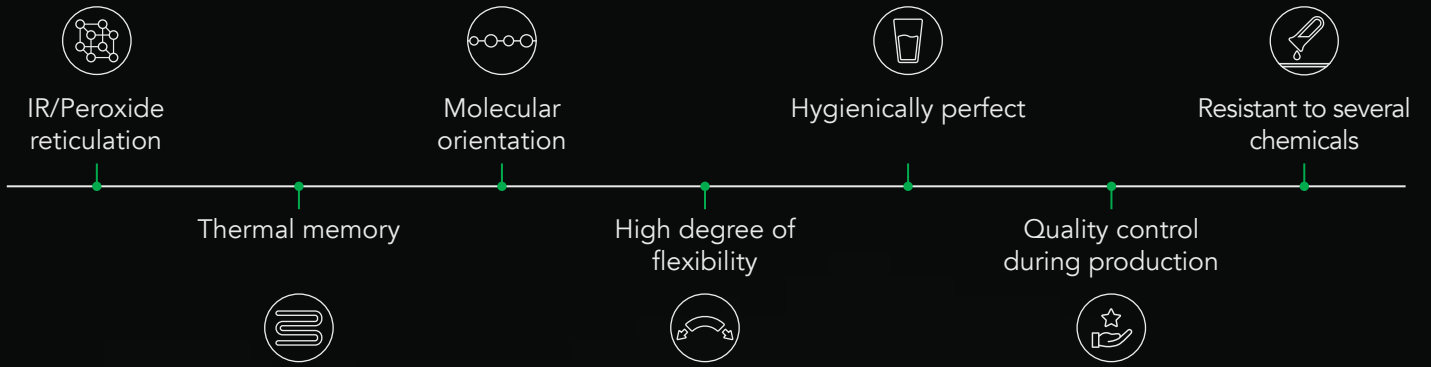

CERTIFICATIONS

The following national and international standards, regulations and listings are applicable to HELIROMA piping systems.
The high resilience of PE-Xa pipes checked regularly through several tests during the production and at laboratory.

STANDARDS:

EN ISO 15875: Plastics piping systems for hot and cold-water installations - Crosslinked polyethylene (PE-X).

DIN 16893: Crosslinked high-density polyethylene (PE-X) pipes – Dimensions.

RP01.03: Rules for crosslinked polyethylene (PE-X) piping systems for hot and cold water installations.

EN 9001: Quality management systems: requirements.



SOON





PE-Xa | PRODUCT RANGE

- PE-Xa PIPE
- PE-Xa EVOH PIPE

PE-Xa PEXROMA

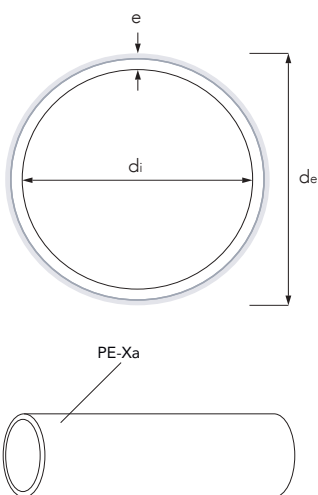

CHARACTERISTICS

SUPPLIED IN	ø 12-32 mm - coils ø 12-32 mm - 4 m bars
LAYERS	Monolayer
CROSSLINKING METHOD	IR/Peroxide
STANDARDS	EN ISO 15875 DIN 16893 RP 01.03



REFERENCE	dn NOMINAL DIAMETER	de OUTSIDE DIAMETER		e THICKNESS		di INSIDE DIAMETER	WEIGHT	MAX WEIGHT W/ WATER *	SERIES
		Min.	Max.	Min.	Max.				
		(mm)				(kg/m)			
P-002012-XA	12x2,0	12	12,3	2,0	2,2	8,0	0,063	0,113	2.5
P-011016-XA	16x1,8	16	16,3	1,8	2,1	12,4	0,081	0,202	4.0
P-001016-XA	16x2,0	16	16,3	2,0	2,3	12	0,087	0,200	3.5
P-002016-XA	16x2,2	16	16,3	2,2	2,6	11,6	0,095	0,201	3.2
P-001017-XA ⁽¹⁾	17x2,0	17	17,3	2,0	2,3	13,0	0,094	0,227	3.8
P-001018-XA ⁽¹⁾	18x2,0	18	18,3	2,0	2,3	14,0	0,100	0,254	4.0
P-011020-XA	20x1,9	20	20,3	1,9	2,2	16,2	0,112	0,318	5.0
P-001020-XA	20x2,0	20	20,3	2,0	2,3	16,0	0,116	0,317	4.5
P-002020-XA	20x2,8	20	20,3	2,8	3,2	14,4	0,152	0,315	3.2
P-001025-XA	25x2,3	25	25,3	2,3	2,7	20,4	0,161	0,488	5.0
P-002025-XA	25x3,5	25	25,3	3,5	4,0	18,0	0,235	0,489	3.2
P-011032-XA	32x2,9	32	32,3	2,9	3,3	26,2	0,266	0,805	5.0
P-002032-XA ⁽¹⁾	32x4,4	32	32,3	4,4	5,0	23,2	0,364	0,787	3.2

Note: standard colour: natural. Other colours on demand.

* Water max. weight calculated with ρ_{H_2O} at 4°C; | ⁽¹⁾ Available on demand.

PE-Xa EVOH PEXROMA EVOH

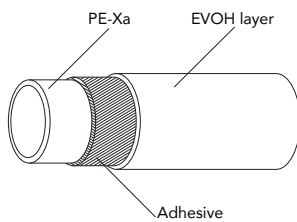
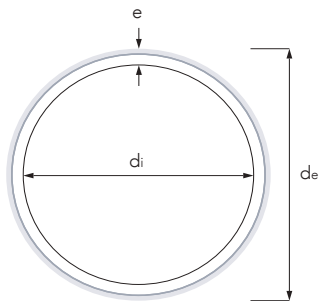

CHARACTERISTICS

SUPPLIED IN	ø 16-32 mm - coils ø 16-32 mm - 4 m bars
LAYERS	3 layer w/ EVOH
CROSSLINKING METHOD	IR/Peroxide
STANDARDS	EN ISO 15875 DIN 16893 RP 01.03



REFERENCE	d _n NOMINAL DIAMETER	d _e OUTSIDE DIAMETER		e THICKNESS		d _i INSIDE DIAMETER	WEIGHT	MAX WEIGHT W/ WATER *	SERIES
		Min.	Max.	Min.	Max.				
		(mm)				(kg/m)			
P-002012-XA ⁽¹⁾	12x2,0	12	12,3	2,0	2,2	8,0	0,063	0,113	2.5
P-011016-XA	16x1,8	16	16,3	1,8	2,1	12,4	0,081	0,202	4.0
P-001016-XA ⁽¹⁾	16x2,0	16	16,3	2	2,3	12,0	0,087	0,200	3.5
P-002016-XA ⁽¹⁾	16x2,2	16	16,3	2,2	2,6	11,6	0,095	0,201	3.2
P-001017-XA ⁽¹⁾	17x2,0	17	17,3	2,0	2,3	13,0	0,094	0,227	3.8
P-001018-XA ⁽¹⁾	18x2,0	18	18,3	2,0	2,3	14,0	0,100	0,254	4.0
P-011020-XA	20x1,9	20	20,3	1,9	2,2	16,2	0,112	0,318	5.0
P-001020-XA ⁽¹⁾	20x2,0	20	20,3	2,0	2,3	16,0	0,116	0,317	4.5
P-002020-XA ⁽¹⁾	20x2,8	20	20,3	2,8	3,2	14,4	0,152	0,315	3.2
P-001025-XA ⁽¹⁾	25x2,3	25	25,3	2,3	2,7	20,4	0,161	0,488	5.0
P-002025-XA ⁽¹⁾	25x3,5	25	25,3	3,5	4,0	18,0	0,235	0,489	3.2
P-011032-XA ⁽¹⁾	32x2,9	32	32,3	2,9	3,3	26,2	0,266	0,805	5.0
P-002032-XA ⁽¹⁾	32x4,4	32	32,3	4,4	5,0	23,2	0,364	0,787	3.2

Note: standard colour: natural. Other colours on demand.

* Water max. weight calculated with ρ_{H₂O} at 4°C; | ⁽¹⁾ Available on demand.



PE-RT

5

PE-RT PIPES - ROMAPLUS

- PE-RT | PE-RT EVOH

INSTALLATION GUIDELINES

PIPE GENERAL ADVANTAGES

CERTIFICATIONS

PRODUCT RANGE

- PE-RT pipe
- PE-RT EVOH pipe

PE-RT PIPES - ROMAPLUS

PE-RT | PE-RT EVOH



CHARACTERISTICS



HEATING SYSTEMS



APPROVED FOR DRINKING WATER



DISINFECTION RESISTANT



LEGIONELLA CONTROL



100% RECYCLABLE



ECO-FRIENDLY

PIPE CLASSIFICATION

SDR Standard dimension ratio – ratio between pipe's outside diameter and it's wall thickness

$$SDR = \frac{d_e}{e}$$

S Series - dimensionless index, which is used for the calculation of the wall thickness of the pipe.

$$S = \frac{d_e - e}{2e}$$

d_e Outside diameter of the pipe

e Wall thickness of the pipe

MATERIAL

PE-RT Polyethylene of Raised Temperature

EVOH Oxygen Barrier

PRODUCT RANGE OVERVIEW

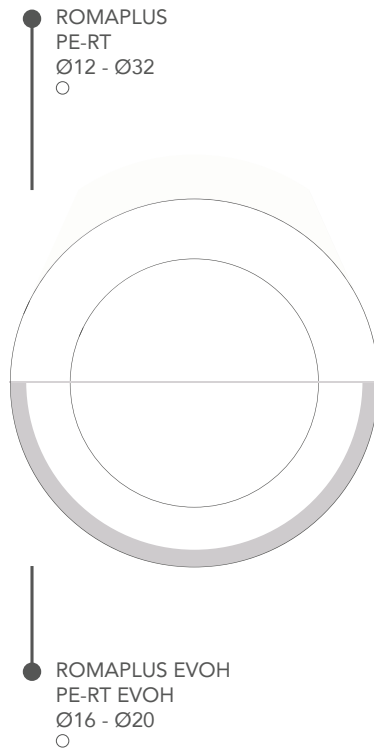

PE-RT PIPES						
DIAMETERS (mm)	12	16	17	20	25	32
ROMAPLUS PE-RT PIPE	✓	✓		✓	✓	✓
ROMAPLUS EVOH PE-RT EVOH PIPE		✓	✓	✓		

Notes: standard colour: natural. Other colours or dimensions available on demand.



ROMAPLUS PIPE

ROMAPLUS: PE-RT PIPE

ROMAPLUS is a pipe made of a specially modified high density polyethylene – PERT type II, with a unique molecular structure and crystalline microstructure, which provides an excellent long thermal stability, high tenacity, high degree of mechanical strength up to temperatures of 90°C and a good long term hydrostatic strength behaviour. In addition, the pipes have a high stability against stress corrosion.

Only prime and high-quality raw materials from top rated suppliers are used on HELIROMA PE-RT pipe production, without any addition of recycled material.

Thanks to its flexibility and high performance, ROMAPLUS pipe is ideal for manifold systems.

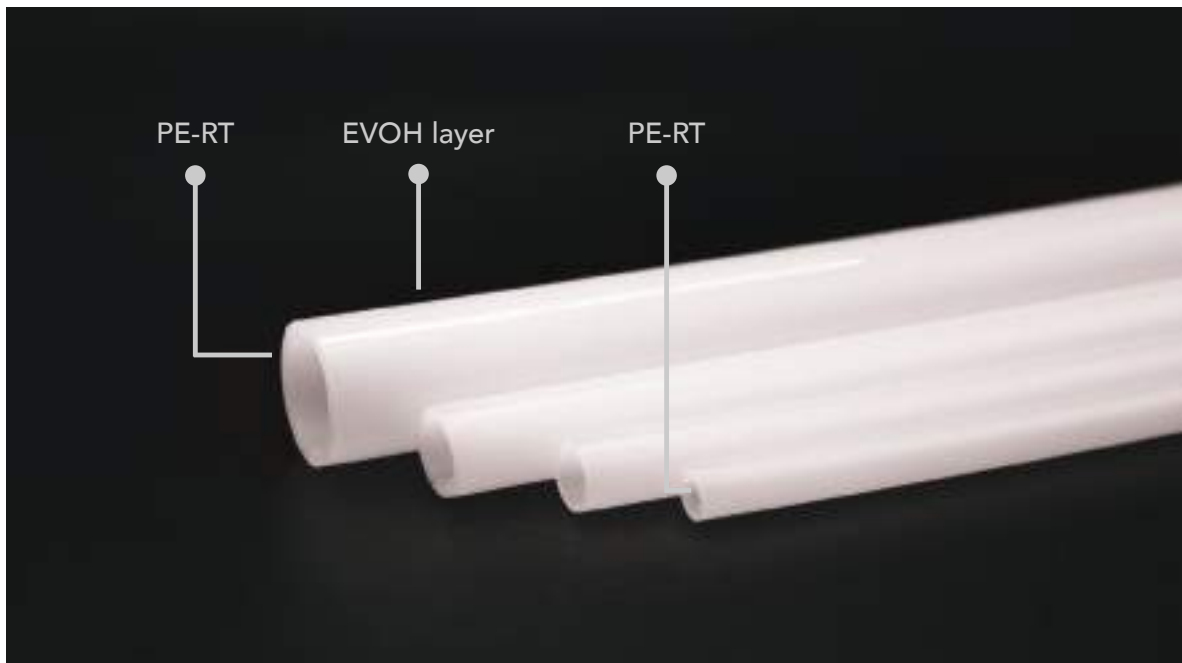

PE-RT type II is polyethylene octane copolymer, a new family of polyethylene raw materials, with excellent stress cracking resistance, outstanding long-term hydrostatic strength, and excellent processability without need for crosslinking.

PE-RT type II pipes has long-term stability and higher hoop stress compared with PE-RT type I pipes. For same resistance, PE-RT type II pipes have a wall thickness reduction around 14% in comparison with PE-RT type I pipes. The strength differences between PE-RT type I and type II can be observed on the graphics below.

ROMAPLUS can be supplied in a monolayer without an oxygen barrier – ROMAPLUS (PE-RT type II), or a multilayer pipe with an oxygen barrier – ROMAPLUS EVOH (PE-RT type II w/EVOH).

EXPECTED STRENGTH OF PE-RT ACCORDING TO ISO 22391-2

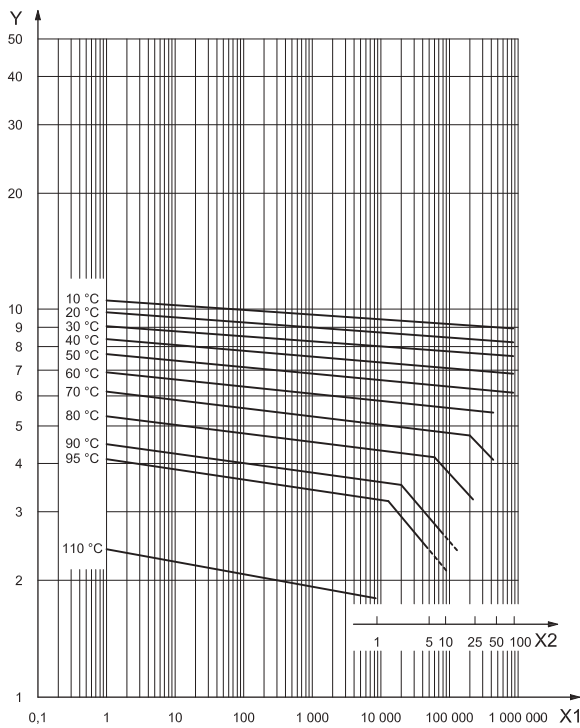

a) PE-RT Type I

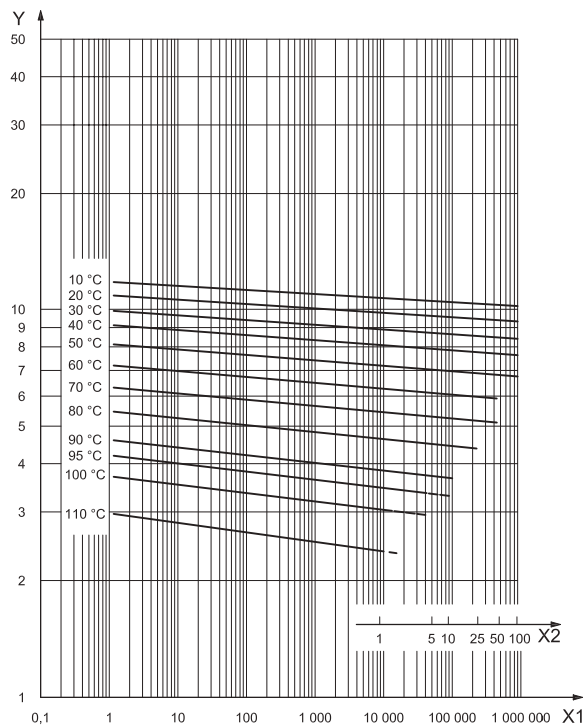

b) PE-RT Type II

KEY

- X1 Time, t1, to fracture, in hours
- X2 Time, t2, to fracture, in years
- Y Hoop stress, σ , in megapascal

OXYGEN BARRIER

The Oxygen Barrier is provided by an ethylene vinyl alcohol – EVOH layer prevents oxygen permeability in the system which reduces corrosion within the system, thus reducing premature failing of system components.

The EVOH layer provides excellent functional barrier against organic solvents and gases. With its exceptional elasticity it protects the product integrity. The Oxygen Barrier seals the oxygen access, therefore increasing the installation life expectancy. In a multilayer pipe, all layers are connected permanently via adhesive.



PE-RT w/EVOH is built on a 3-layer structure, manufactured by means of extrusion in one single process, PE-RT type II in internal layer, a special bonding agent in the middle layer and a final EVOH external layer. The pipe fulfils all the requirements for the oxygen diffusion resistance according applicable standards. The three-layer structure achieves a high degree of oxygen tightness and ensures that this is retained even under rough building site conditions.

In sanitary water systems, because water is already oxygenated to saturation point, no diffusion takes place. Nevertheless, in heating systems the established requirements for resistance to diffusion, make ROMAPLUS w/EVOH the ideal solution.

Romaplus and Romaplus EVOH is supplied on natural colour. Romaplus EVOH can be coloured on the EVOH layer.

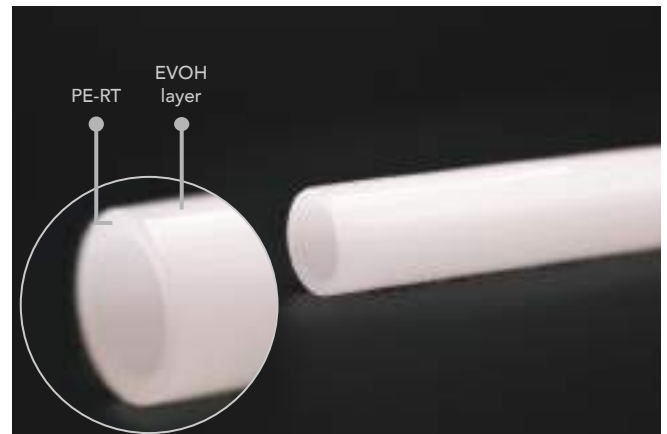

EVOH PROPERTIES

PARAMETER	VALUE	STANDARD
OTR - 20°C, 0% RH	0,2 cm ³ .20µm/m ² .day.atm	ASTM D3985
OTR - 20°C, 65% RH	0,4 cm ³ .20µm/m ² .day.atm	ASTM D3985
OTR - 20°C, 85% RH	1,5 cm ³ .20µm/m ² .day.atm	ASTM D3985
OTR - 20°C, 100% RH	1,9 cm ³ .20µm/m ² .day.atm	ASTM D3985

OTR – Oxygen Transmission Rate

PE-RT: RAW MATERIAL AND PIPE PROPERTIES

PARAMETER	VALUE	STANDARD
PHYSICAL		
Density	941 kg/m ³	ISO 1183
MFI - 190°C/2.16 kg	0,60 g/10min	ISO 1133
MFI - 190°C/5.00 kg	1,9 g/10min	ISO 1133
Roughness	0,007 mm	ISO 5436
Moisture Absorption	<0,01 mg/4 day	ISO 62
MECHANICAL		
Tensile Modulus (23°C)	645 MPa	ISO 527
Tensile Stress At Yield (23°C)	20.3 MPa	ISO 527
Tensile Strain Yield	20 MPa	ISO 527
Tensile Stress At Break	37 MPa	ISO 527
Flexure Modulus	660 MPa	ISO178
Maximum laying temperature	30°C	
Minimum laying temperature	-5 °C	
Pipe Constant	14	
THERMAL		
Vicat Softening Temperature A50	125°C	ISO 306
Melting Temperature	128°C	
Thermal Conductivity	0,35 W/m K	DIN 52612
Thermal Expansion Coefficient	1,8x10 ⁻⁴ m/m °C	VDE 0304
Linear Coefficient	0,026 mm/m K	
Fire Classification	B2	DIN 4102
HARDNESS		
Shore Hardness (Shore D)	61	ISO 868
Unnotched Izod Impact	No Break	ASTM D4812
GENERAL		
Smallest Bend Radius	5 x d _e mm	DIN 4721



ADVANTAGES AND KEY FEATURES OF ROMAPLUS



HIGH TEMPERATURE AND PRESSURE RESISTANCE



DRINKABLE WATER APPLICATIONS



GOOD RESISTANCE TO STRESS CRACKING



OXYGEN DIFFUSION BARRIER – AVOIDING METAL COMPONENTS CORROSION



HIGH TRACTION RESISTANCE



EVOH COLOURED



HIGH CHEMICAL RESISTANCE



SUPPLIED IN COILS



CORROSION AND INCRUSTATION RESISTANCE



RECYCLABLE



EASY TO INSTALL



ECO-FRIENDLY



LIGHTWEIGHT AND FLEXIBLE



NATIONAL AND INTERNATIONAL CERTIFICATIONS

APPLICATIONS

The ROMAPLUS has a wide range of applications, as well as working pressures and temperatures such as: new installations, repairs, renovations and prefabricate installations.

PE-RT pipe is suitable for use in all hot and cold water piping, such as: underfloor, wall and ceiling heating/colling systems, general heating systems, tap water system.

In heating systems applications ROMAPLUS w/EVOH must be applied.

The ISO 22391-2 defines four classes of application, with a specific combination of working pressure and temperature. In the table below is shown the working pressure and temperature for PE-RT type II pipes, according to their series.

APPLICATION CLASS		P _D (bar)					
		ROMAPLUS & ROMAPLUS EVOH					
SERIES		2,5	3,2	3,5	4,0	4,5	5,0
1	Hot water supply 60°C	10	10	8	6	6	6
2	Hot water supply 70°C	10	8	8	6	6	6
4	Underfloor heating and low temperature radiators	10	8	8	6	6	8
5	High-temperature radiators connection	10	8	6	6	4	6

PIPE MARKING

The following sequence must be printed once per meter in all pipes.

Example:

HR HELIROMA ROMAPLUS ISO 22391-2 PERT TIPO II (Símbolo)AENOR 001/621 Certif 16x2.0 mm – C Classe 1/10 2/8 4/8 5/8 bar L DD/MM/YY HH:MM OP Made in Portugal

MARKED SYMBOL	DESCRIPTION
HR Heliroma	Manufacturer's name
ROMAPLUS	Product trade mark
ISO 22391-2	Product Regulations
PE-RT TIPO II	Material
AENOR, Certif	Certificates, Approvals
$d_e \times e$	Nominal outside diameter x Nominal wall thickness
C	Pipe dimension class (according ISO 22391)
1/8 2/6 4/8 5/6 bar	Application class combined with operating pressure
L	Machine number
12/04/2001 13:31	Date of manufacture
OP-3/01	Production order number
Made in Portugal	Additional information

DIMENSIONS AND FLOW RATE

PIPE	DN	Wall Thickness (mm)	Speed (m/s)	Flow Capacity		
				m ³ /h	L/s	L/h
ROMAPLUS AND ROMAPLUS EVOH	12	2,0	2	0,362	0,101	362
	16	1,8		0,869	0,242	869
	16	2,0		0,814	0,226	814
	17	2,0		0,956	0,265	956
	20	1,9		1,484	0,412	1484
	20	2,0		1,448	0,402	1448
	25	2,3		2,353	0,654	2353
	32	2,9		3,882	1,078	3882

INSTALLATION GUIDELINES

GENERAL RECOMMENDATIONS

Before starting to work with HELIROMA's products it is very important to read the technical catalogue:

- HELIROMA's systems have to be assembled according to HELIROMA's instructions;
- For applications or conditions not mentioned, make sure to obtain HELIROMA's technical approval;
- All regulations and directives have to be fulfilled on designing and installation phases;
- Product warranty is valid only for HELIROMA's products.

DESIGNING GUIDELINES

The design and layout of the building hot and cold water distribution system shall comply with accepted plumbing engineering practice and as per local requirements.

Compliance with local regulations is mandatory and responsibility of the installer.

THERMAL EXPANSION

Due to laws of physics, all piping materials expand when heated and contract when cooled.

When thermal expansion is anticipated, pipe movement should be controlled to prevent changes that could damage the piping system.

PE-RT pipe has great linear expansion and small expansive forces compared to metal pipes. With concealed installation, linear expansion takes place between pipe and conduit. On wall mounted installations, the expansive forces are transferred to expansion absorbing devices (previously planned) or to the building structure through fixing.

The thermal change in length is calculated with the following equation (Annex A, table of the pipe linear expansion):

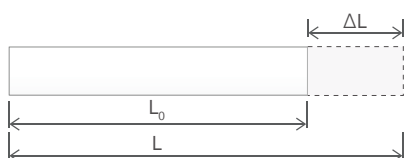

THERMAL EXPANSION FORMULA

$$\Delta L = L - L_0 = L_0 \times \alpha \times \Delta T$$

ΔL Linear expansion ($L - L_0$) (mm)

L Final length of the pipe, at T temperature (m)

L_0 Initial length of the pipe, at T_0 temperature (m)

α Linear expansion coefficient: $\alpha = 0,026 \text{ mm/m}^\circ\text{C}$

ΔT Variation of pipe temperature, in $^\circ\text{C}$ ($T - T_0$)

CORROSION

ROMAPLUS pipe is non-reactive and displays excellent corrosion resistance, erosion corrosion does not occur even at high water speed.

The high resistance to corrosion allows to PE-RT pipes to be used for various applications, even industrial ones.

FREEZING

ROMAPLUS pipes should not be exposed to freezing temperatures, specially if the pipes are filled with water. The PE-Xa pipe can normally tolerate freezing, due to its flexibility, however, if the pipe is not allowed to expand it may burst resulting in leaks and operational failures. Repeated freezing weakens the pipe.

BENDING

ROMAPLUS pipe may be bent with specific bending tools or by hand. The modulus of elasticity as an important parameter of the bending resistance of the pipe is for PE-RT and PE-RT EVOH 660 MPa. The minimum recommended radius is $5d_e$ with hot bending. The minimum bending radius cannot be less than those specified for each producer, according to pipe characteristics.



PIPE FEATURES

ROMAPLUS is a reliable product which is constantly controlled by engineers and technicians in our in-house laboratory in order to ensure dimensional accuracy, material quality and endurance.

HELIROMA focus is on the development of new solutions for a range of applications, always developing new visionary products fulfilling the highest requirements in close partnership with our customers.

HELIROMA PE-RT pipe production is energetically efficient with low environmental impact

HELIROMA always adopts ecological practices, considering environmental protection and save natural of sources.

Finally, HELIROMA's PE-RT pipe is available in several diameters and thicknesses, coil lengths and with EVOH colour. The pipes can be processed according to customer drawings and specifications.



LEAKAGE TEST

All HELIROMA products must be submitted to a leakage test. The product warranty is only valid if the leakage test has been performed, on the date the system has been installed.

Before the pressure test, it must be ensured that all components of the installation are freely accessible and visible, in order to identify unpressed or incorrectly installed fittings. Pressure test must be carried out before the system is put into operation and before they are insulated and sealed.

It is recommended to perform the pressure test with compressed air or inert gas if the pipeline system is to remain unfilled after a pressure test. When the pressure test is performed with water, despite draining the system, residual water can remain in some sections, this is an ideal environment for bacteria.

LEAK TEST WITH COMPRESSED AIR OR INERT GAS

A pressure test with compressed air or inert gases is carried out in two stages: leak test (checking the system for leaks. Unpressed and inadequately screwed connections can be identified in this way) and load test (checking the system for the quality of the material and installation process). Both stages must be performed under recognized engineering best practices.

Before the leakage test, all equipments, water heaters, fittings, or pressure valves or pressure vessels must be disconnected from the system. The air volume can affect safety and testing accuracy.

All lines must be directly sealed with material which can withstand the test pressure. Closed stop valves are not enough to a tight shut-off.

Before starting the test stages, it is important to wait for temperature equalisation and steady-state condition after pressure build-up.

For safety reasons, the test pressures are set to a maximum of 3 bar. The pressure should be gradually increased up to the required pressure. If a pressure drop occurs during the test period, there is a leak in the system, repeat the leak test.

Leak test – Stage 1

All pipe connections must be visually inspected, before starting the test.

The manometer used must have an accuracy of 1 mbar.

The test pressure is 150 mbar. For systems up to 100 litres volume, the test must run for, at least, 120 minutes. For bigger volume systems, The time must be extended 20 minutes per additional 100 litres.

During the test stages cannot occur any leakage.

Load Test – Stage 2

Following the leak test, the load test is carried out.

Pipe sizes $d_g \leq 63$ mm, for a system volume up to 100 litres, the pressure is increased to 3 bar maximum.

Pipe sizes $d_g > 63$ mm, for a system volume up to 100 litres, the pressure is increased to 1 bar maximum.

For a system volume of up to 100 litres, the test time must be at least 10 minutes.

The sealing of the system must be evident, and after that must be confirmed with a written record, that has to be signed by the installer, stating place and date and sent to HELIROMA technical department.

Please refer to the test protocol recommended in Annex D.

LEAK TEST WITH WATER

The pressure test checks the tightness of the pipe installation as well as the axial restraint of the connections.

All pipe connections must be visually inspected, before starting the test. The local regulations and/or standards must always be considered during the pressure test.

Before starting the test stages, it is important to wait for temperature equalisation and steady-state condition after pressure build-up.

If the pressure falls during the test period, there is a leak in the system, meaning that the leak test must be repeated.

There must be no drop in pressure and no visible indication of leakage.

The sealing of the system must be evident, and after that must be confirmed with a written record, that has to be signed by the installer, stating place and date and sent to HELIROMA technical department.

Please refer to the protocol recommended in Annex D.

CHEMICAL RESISTANCE

ROMAPLUS and ROMAPLUS EVOH have very good resistance to chemical-dissolving agents. The unique molecular structure is stable and inert, and it is virtually unaffected by chemicals (organic or inorganic) commonly found in plumbing systems. Contact Heliroma Technical Department for specific chemical compatibility verification.

TRANSPORT AND STORAGE

HELIROMA pipes can be stored outdoor or indoor but preferably in a covered area, protecting them from direct sunlight and low temperatures.

Pipes and fittings must not be exposed to direct UV-radiation, for long periods. This radiation has effects on the durability of all polymer plastics. Do not store permanently outdoor.

Despite the high quality and resistance of all HELIROMA products, they should be handled with caution. Do not drop the pipes when unloading them and protect them from falling object, or equipments. The process of loading, transport and subsequent unloading should be carried out making sure that pipes and fittings do not take any damage.

Pipes and fittings should be kept in their original packaging if at all possible until processed. Damaged, bent or deformed pipes must not be processed.

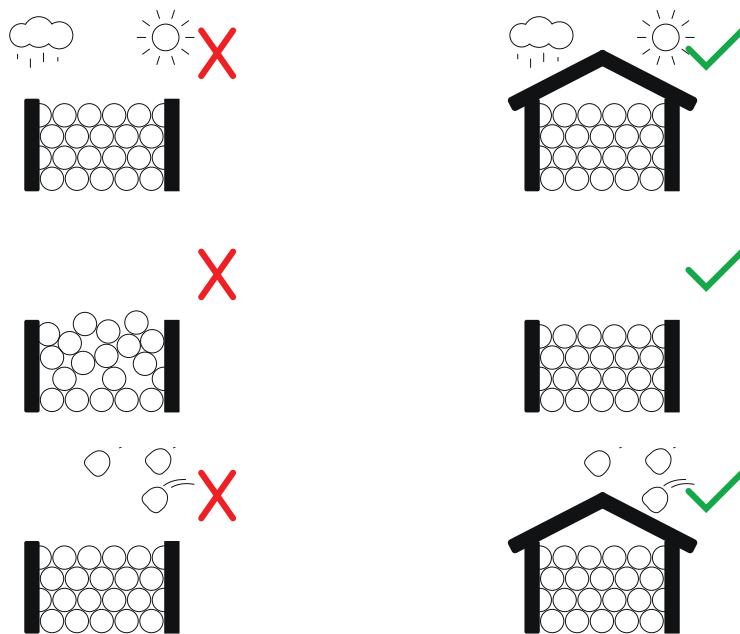

WARRANTY

All supplied products by HELIROMA installed according all procedures in HELIROMA catalogue, have 10 years warranty against manufacturing defects.

For further information, consult the general terms and conditions.

PIPE GENERAL ADVANTAGES

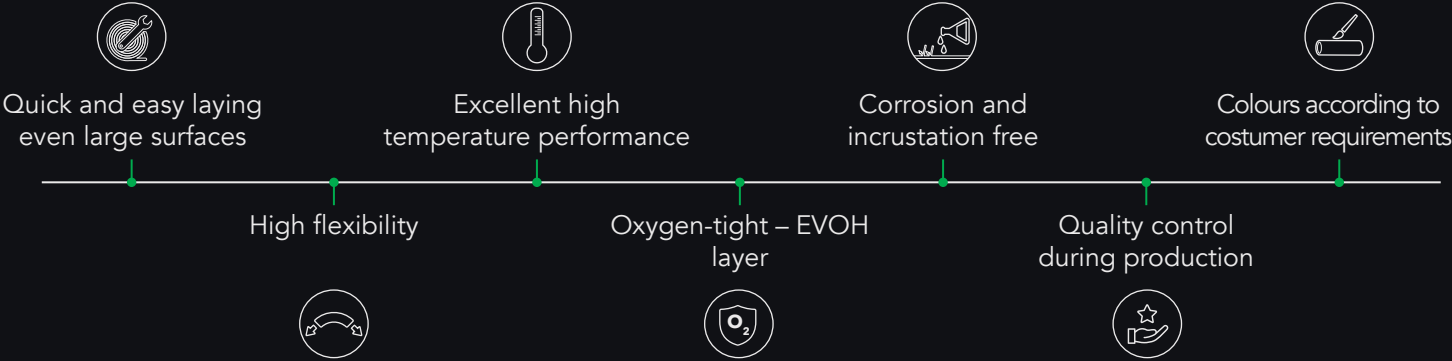

CERTIFICATIONS

The following national and international standards, regulations and listings are applicable to HELIROMA piping systems.

The high resilience of PE-RT pipes is checked regularly through several tests during the production and at laboratory.

STANDARDS:

ISO 22391: Plastics piping systems for hot and cold water installations — Polyethylene of raised temperature resistance (PE-RT).

DIN 16833 : Polyethylene pipes of raised temperature resistance (PE-RT) - PE-RT Type I and PE-RT Type II - General quality requirements testing.

DIN 16834: Polyethylene pipes of raised temperature resistance (PE-RT) - PE-RT Type I and PE-RT Type II - Dimensions

RP01.67: Rules for plastic piping systems for hot and cold water installations. Temperature resistant polyethylene (PE-RT).

EN 9001: Quality management systems: requirements.







PE-RT | PRODUCT RANGE

- PE-RT PIPE
- PE-RT EVOH PIPE

PE-RT ROMAPLUS

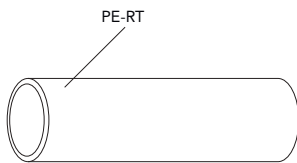
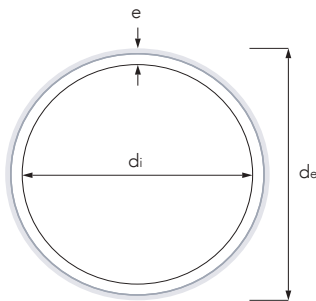

CHARACTERISTICS

SUPPLIED IN	ø 12-32 mm - coils ø 12-32 mm - 4 m bars
LAYERS	Monolayer
STANDARDS	EN ISO 15875 DIN 16893 RP 01.03



REFERENCE	d _n NOMINAL DIAMETER	d _e OUTSIDE DIAMETER		e THICKNESS		d _i INSIDE DIAMETER	WEIGHT	MAX WEIGHT W/ WATER *	SERIES
		Min.	Max.	Min.	Max.				
		(mm)				(kg/m)			
P-002012-RT ⁽¹⁾	12x2,0	12	12,3	2,0	2,2	8,0	0,063	0,113	2.5
P-011016-RT	16x1,8	16	16,3	1,8	2,1	12,4	0,081	0,202	4.0
P-001016-RT	16x2,0	16	16,3	2,0	2,3	12,0	0,087	0,200	3.5
P-001020-RT	20x2,0	20	20,3	2,0	2,3	16,0	0,116	0,317	4.5
P-001025-RT	25x2,3	25	25,3	2,3	2,7	20,4	0,161	0,488	5.0
P-001032-RT ⁽¹⁾	32x2,9	32	32,3	2,9	3,3	26,2	0,266	0,805	5.0

Note: standard colour: natural. Other colours on demand.

* Water max. weight calculated with p_{H₂O} at 4°C; ⁽¹⁾ Available on demand.

PE-RT EVOH ROMAPLUS EVOH

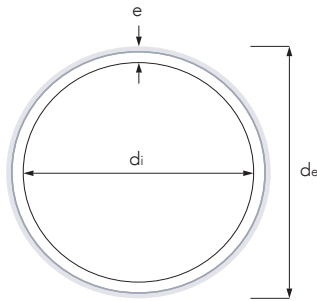

CHARACTERISTICS

SUPPLIED IN	ø 16-32 mm - coils ø 16-32 mm - 4 m bars
LAYERS	3 layer w/ EVOH
STANDARDS	EN ISO 15875 DIN 16893 RP 01.03

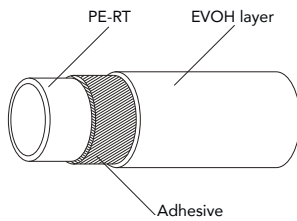

REFERENCE	d _n NOMINAL DIAMETER	d _e OUTSIDE DIAMETER		e THICKNESS		d _i INSIDE DIAMETER	WEIGHT	MAX WEIGHT W/ WATER *	SERIES
		Min.	Max.	Min.	Max.				
		(mm)				(kg/m)			
P-011016-RT	16x1,8	16	16,3	1,8	2,1	12,4	0,081	0,202	4.0
P-001016-RT	16x2,0	16	16,3	2	2,3	12,0	0,087	0,200	3.5
P-001017-RT ⁽¹⁾	17x2,0	17	17,3	2,0	2,3	13,0	0,094	0,227	3.8
P-011020-RT	20x1,9	20	20,3	1,9	2,2	16,2	0,112	0,318	5.0
P-001020-RT	20x2,0	20	20,3	2,0	2,3	16,0	0,116	0,317	4.5

Note: standard colour: natural. Other colours on demand.

* Water max. weight calculated with ρ_{H₂O} at 4°C; | ⁽¹⁾ Available on demand.



ULTRA SILENT 6

ULTRA SILENT SYSTEM

INSTALLATION GUIDELINES

SYSTEM FEATURES

SYSTEM GENERAL ADVANTAGES

CERTIFICATIONS

PRODUCT RANGE

- ULTRA SILENT Pipes
- ULTRA SILENT Fittings

ULTRA SILENT SYSTEM

ULTRA SILENT PIPES AND FITTINGS



CHARACTERISTICS



APPROVED FOR DRAINAGE SYSTEMS



SOUNDPROOF



UV PROTECTION



CHEMICAL RESISTANT



100% RECYCLABLE



ECO-FRIENDLY

PLASTIC PIPES CLASSIFICATION

SDR Standard dimension ratio – ratio between pipe's outside diameter and it's wall thickness

$$SDR = \frac{d_e}{e}$$

S Series - dimensionless index, which is used for the calculation of the wall thickness of the pipe

$$S = \frac{d_e - e}{2e}$$

d_e Outside diameter of the pipe

e Wall thickness of the pipe

MATERIAL

PP Polypropylene

PP-MD Mineral Modified Polypropylene

PRODUCT RANGE OVERVIEW

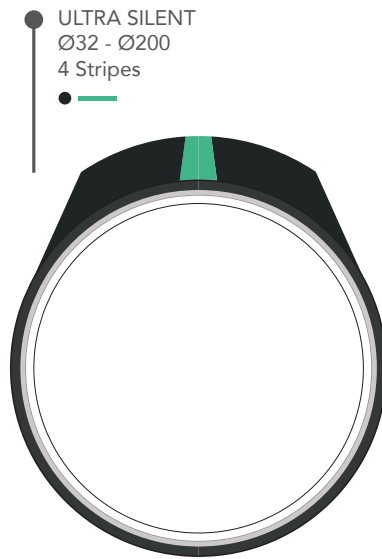

ULTRA SILENT PIPES AND FITTINGS

DIAMETERS (mm)	32	40	50	75	90	110	125	160	200
USEM SINGLE SOCKET PIPE	✓	✓	✓	✓	✓	✓	✓	✓	✓
USDM DOUBLE SOCKET PIPE	✓	✓	✓	✓	✓	✓	✓		
FITTINGS	✓	✓	✓	✓	✓	✓	✓	✓	✓



ULTRA SILENT SYSTEM

Soundproof, triple layer, push-fit system made of pipes and fittings for soil and waste discharge, at low and high temperatures, both within the building structure (application area code "B") as well as buried in the ground (application area "BD").

Pipes have a three-layer wall structure with external and internal layers of polypropylene (PP) and a middle layer of mineral-filled polypropylene (PP-MD). Fittings are made of mineral filled Polypropylene (PP-MD). Materials are halogen and cadmium free.

Joints are made with push-fit sockets and elastomer seals.

Suitable for the drainage of fluids, in compliance with DIN 8078, with pH between 2 and 12 at atmospheric pressure and at maximum operating temperature between 95°C and 98°C for short periods.

Suitable for the construction of ventilation, rainwater and drainage systems. Can be used at environmental temperatures up to minimum of -25°C.

The system has a sound level $L_{sc,A}$ of 15dB(A) at a flow rate of 2 L/s, measured in compliance with EN 14366 and certified by the Fraunhofer Institut Für Bauphysik of Stuttgart number P-BA 20/2019e. The test was conducted using Hultot acoustic clamps.

Fire performance rating is D-s2,d2 in compliance with EN 13501-1.

The Ultra Silent™ System is certified by: SKZ, DiBt - Germany, DTI- Denmark, AENOR - Spain and SII – Israel. In compliance with HR 3.43, EN 14759, UNE EN 1451-1, IS 958 "Plastics piping system for soil and waste discharge (low and high temperature) within the building structure".

Suitable for external installation when protected from exposure to direct sunlight (for instance, by means of special UV protective coating); can be stored outside up to two years.



ULTRA SILENT PROPERTIES

PARAMETER	VALUE	STANDARD
PHYSICAL		
Seal Material	SBR-NR, NBR, EPDM	
Colour	Black	
Inside Colour	White	
Density - Pipes	1,3-1,4 g/cm ³	
Density - Fittings	1,18-1,25 g/cm ³	
UV Resistance	Yes	
Connection	Push-fit sockets with elastomer rubber seals	
MECHANICAL		
Elasticity Modulus	2.300 - 3.000 N/mm ²	ISO 178
Thermal Expansion Coefficient	0,09 mm/m C°	
Ring Stiffness	SN6 (6,0 kN/m ²)	ISO 9969
Halogen & Cadmium Content	Free of halogen or cadmium	
Chemical Resistance	pH 2 to pH 12	
THERMAL		
Minimum Working Temperature	-25°C	
Waste Water Temp. (Max.) Continuous	+95°C	
Waste Water Temp. (Max.) Discontinuous	+98°C	
Fire Resistance	D-s2, d2 B2	EN 13501-1 DIN 4102-1
ACOUSTIC		
Acoustic Performance	L _{sc,A} = 15 dB(A) at 2 L/s, measured at ground level behind installation wall, with two Huliot acoustic clamps per floor	EN 14366

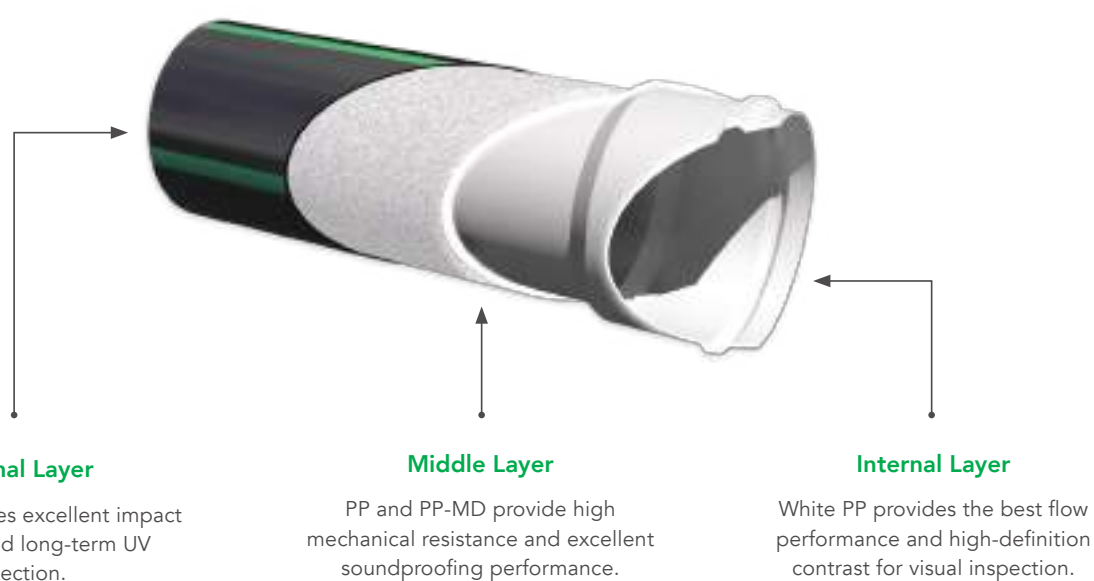

ADVANTAGES AND KEY FEATURES OF ULTRA SILENT



EXCELLENT SOUNDPROOF PERFORMANCE



HIGH MECHANICAL RESISTANCE



HIGH TEMPERATURE RESISTANCE



EASY AND SAFE INSTALLATION



EFICIENT DESIGN



WIDE DIMENSIONAL RANGE



UV PROTECTION



LIGHTWEIGHT



LONG LIFE EXPECTANCY



IDEAL FOR VISUAL INSPECTIONS



ECO-FRIENDLY



NATIONAL AND INTERNATIONAL CERTIFICATIONS

APPLICATIONS

The Ultra Silent™ System is ideal for:

- High and low temperature domestic waste water drainage systems;
- Ventilation of waste water drainage systems;
- Rain water drainage systems;

It can be installed inside or on the perimeter of residential, industrial and other types of buildings according to the EN 1451 Standard.

The Area of application for Ultra Silent™ system is BD.

BD is the combination of both areas of application B and D for waste water drainage.

B is the marking which identifies that a certain pipe system (minimum S16 series) may be installed inside or outside the building anchored to the walls.

D is the marking which identifies that a pipe system may be buried within 1 meter of the perimeter of the building directly connected to the sewer system and can be installed under or embedded in the building structure elements.

PIPE MARKING

Example:

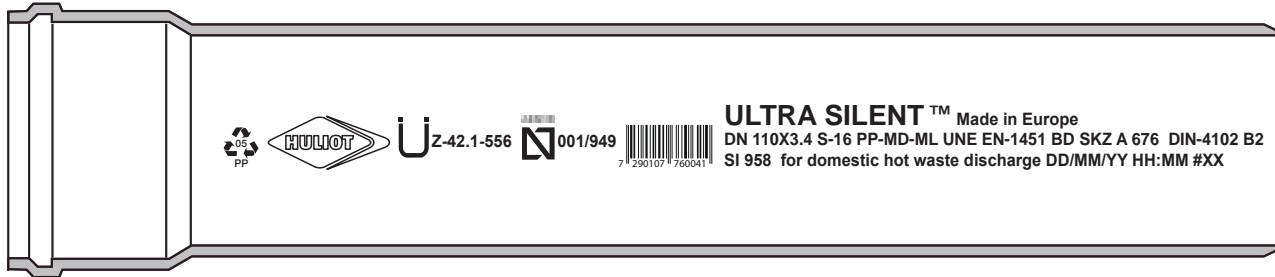

MARKED SYMBOL	DESCRIPTION
PP	Recyclable product
Huliot Logo	Manufacturer logo
DIBt Z-42.1-556	DIBT approval
AENOR 001/949	AENOR product certificate
Barcode	Product barcode
Ultra Silent™	System brand name
DN 110X3.4	Diameter and wall thickness
PP-MD-ML	Material
S-16	Pipe series
UNE EN-1451	Production standard
BD	Application area
SKZ A 676	Certificate number
DIN 4102 B2	Fire resistance classification
SI 958	SI Standard
for domestic hot waste discharge	Pipe application
DD/MM/YY	Production date
HH:MM #XX	Production time and place

FITTINGS

ULTRA SILENT'S wide range of products made of PP and PP-MD offers solutions for various uses in multiple diameters and sizes. Continuous research and development result in the most efficient flux and ease of installation of fittings. The fittings clever design assure the safety of every connection whilst enabling the best smoother flow possible.



FITTINGS MARKING

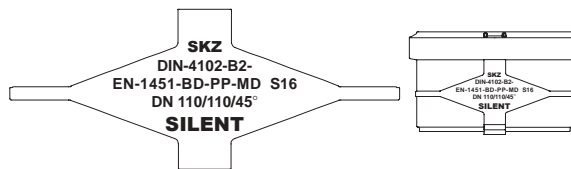

MARKED SYMBOL	DESCRIPTION
SKZ	Approval
DIN 4102 B2	Fire resistance classification
EN 1451 BD PP-MD S16	construction standard and application area, material, series
DN 110/110/87.5°	Type of product, diameters, angle
ULTRA SILENT	System brand name

ACOUSTIC PERFORMANCE

Noise generated from pipelines is common inside buildings when discharges are made. This noise is generated through vibrations from the waste inside the pipeline, transmitted to the pipes themselves and consequently to the building structure and surroundings.

Proper soundproof drainage systems and efficient system design can be installed resulting in a low sound emission drainage system and, consequently, better quality of life.

The soundproof performance of the waste system is measured according to the European Standard EN 14366 with additional evaluation for comparison with requirements following German standards DIN 4109:2018 and VDI 4100:2012.

Fraunhofer Installation plan of the test set-up in the test facility

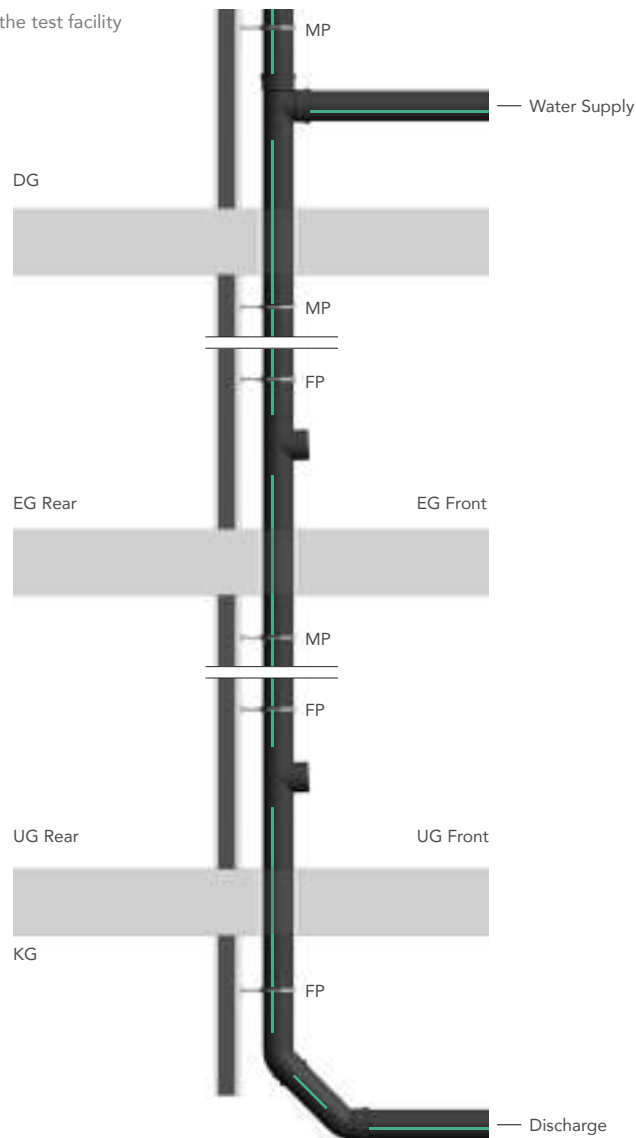

MP - Sliding Clamp

FP - Fixed Clamp

These tests were carried out in the Fraunhofer Institute test facility and the waste water system mounted by a technician under the authority of Fraunhofer IBP.

Fraunhofer IBP is the institution for testing, supervision and certification for noise control and sound insulation measures in buildings, and many other areas, officially recognized by the building supervisory authority.

The test method applied consists on introducing a steady water flow in a predesigned waste water system with a waste stack anchored to a four-storey building and measuring the sound pressure level in multiple predefined rooms.

This building built according to the standard is divided by a partition wall resulting in the front, where the waste stack is installed, and the rear. Then, each floor creates a room with a defined code. The UG Front and UG rear are the measuring rooms represented in the results table.

This measurements results facilitate the comparison between products, materials and system components for waste water installations in terms of their noise insulation properties.

SOUND LEVEL SUMMARY RESULTS (P-BA 20/2019e)

		FLOW RATE (L/s)			
Wastewater system "ULTRA SILENT, D 110x3,4, PP ML MD - S16		0,5	1,0	2,0	4,0
Airborne sound pressure level $L_{a,A}$ [dB(A)] according to EN 14366 for the basement test-room	UG front	43	49	52	54
Structure-borne sound characteristic level $L_{SC,A}$ [dB(A)] according to EN 14366 for the basement test-room	UG rear	<10	11	15	20
Installation sound level $L_{AFeq,n}$ [dB(A)] following DIN 4109 in the basement test-room	UG front	43	49	52	54
	UG rear	<10	15	19	24
Installation sound level $\overline{L}_{AFeq,nT}$ [dB(A)] following VDI 4100 in the basement test-room	UG front	40	47	49	52
	UG rear	<10	12	16	21

It is advised that the measured value at a volumetric flow of 2 L/s should be the one used for comparison as it approximately equates to the mean volumetric flow of a WC flush. According to the Fraunhofer Institute for Building Physics IBP guidelines, for a proper assessment of the measurement results, only test reports published after 2014 should be used.

ULTRA SILENT™ SOUND PRESSURE LEVELS $L_{SC,A}$ EN 14366

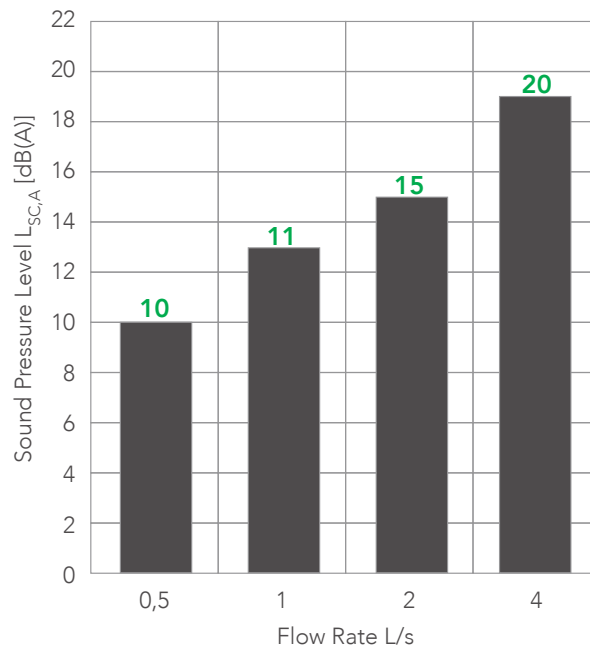

Sound level diagram resulting from Fraunhofer
Test P-BA 20/2019e, according to EN 14366.
The test was conducted using Hulirot acoustic clamp.

CHEMICAL RESISTANCE

Polypropylene is a material suitable for the transport of a certain variety of fluids, which includes a wide range of chemical substances, high and low pressures at high and low temperatures.

In the table below, there is a list that establishes a provisional classification of chemical resistance of PP with respect to about 180 fluids. It's intended to provide general guidelines on the possible utilization of polypropylene pipes.

For specific application where chemical substances should flow on our pipes, please contact HELIROMA technical department to work out suitable solutions with you.

CHEMICAL	CONCENTRATION	20°C	60°C	CHEMICAL	CONCENTRATION	20°C	60°C
Acetic acid	> 40%	✓	✓	Butane	100%	✓	-
Acetic acid	50%	✓	✓	Butanol	100%	✓	□
Acetic acid, glacial	>96%	✓	□	Butyl acetate	100%	✓	□
Acetic anhydride	100%	✓	-	Butyl glycol	100%	✓	-
Acetone	100%	✓	✓	Butyl phenol	Col.sat.sol	✓	-
Acceptophenone	100%	✓	□	Butyl phthalate	100%	✓	□
Acrylonitrile	100%	✓	-	Calcium carbonate	Sat.sol	✓	✓
Air		✓	✓	Calcium chloride	Sat.sol	✓	✓
Almond oil		✓	-	Calcium hydroxide	Sat.sol	✓	✓
Alum	Sol	✓	-	Calcium hypochlorite	Sol	✓	-
Ammonia, aqueous	>30%	✓	-	Calcium nitrate	Sat.sol	✓	✓
Ammonia, dry gas	100%	✓	-	Camphor oil		×	×
Ammonia, liquid	100%	✓	-	Carbon dioxide, dry gas	100%	✓	✓
Ammonium acetate	100%	✓	✓	Carbon dioxide, wet		✓	✓
Ammonium chloride	Sat. sol	✓	-	Carbon disulphide	100%	✓	×
Ammonium fluoride	Sol	✓	✓	Carbon tetrachloride	100%	×	×
Ammonium hydrogen carbon	Sat.sol	✓	✓	Castor oil	100%	✓	✓
Ammonium hydroxide	Sat.sol	✓	-	Caustic soda	>50%	✓	□
Ammonium metaphosphate	Sat.sol	✓	✓	Chorine, aqueous	Sat.sol	✓	□
Ammonium nitrate	Sat.sol	✓	✓	Chlorine, dry gas	100%	×	×
Ammonium phosphate	Sat.sol	✓	-	Chlorine, liquid	100%	×	×
Ammonium sulphate	Sat.sol	✓	✓	Chloroacetic acid	Sol	✓	-
Amyl acetate	100%	□	-	Chloroethanol	100%	✓	-
Amyl alcohol	100%	✓	✓	Chloroform	100%	□	×
Aniline	100%	✓	✓	Chlorosulphonic acid	100%	×	×
Apple juice	100%	✓	-	Chome alum	Sol	✓	✓
Aqua regia	HCl/HNO3=3/1	×	×	Chromic acid	>40%	✓	□
Barium carbonate	Sat.sol	✓	✓	Citric acid	10%	✓	✓
Barium chloride	Sat.sol	✓	✓	Coconut oil		✓	-
Barium hydroxide	Sat.sol	✓	✓	Com oil		✓	□
Barium sulphate	Sat.sol	✓	✓	Cottonseed oil		✓	-
Benzene	100%	✓	×	Cresol	>90%	✓	-
Benzoic acid	Sat.sol	□	-	Copper III Chloride	Sat.sol	✓	-
Benzyl alcohol	100%	✓	□	Copper III nitrate	30%	✓	✓
Borax	sol	✓	✓	Copper III sulphate	Sat.sol	✓	-
Boric acid	Sat.sol	✓	-	Cyclohexane	100%	✓	-
Bromine, gas		□	×	Cyclohexanol	100%	✓	-
Bromine, liquid	100%	×	×	Cyclohexanone	100%	□	×

CHEMICAL	CONCENTRATION	20°C	60°C
Dextrose	Sol	✓	✓
Dibutyl phthalate	100%	✓	□
Dichloroacetic acid	100%	□	-
Dicloroethylene (A-B)	100%	□	-
Diethanolamina	100%	✓	-
Diethyl ether	100%	✓	□
Diethylene glycol	100%	✓	✓
Diglycolic acid	Sat.sol	✓	-
Disooctyl phthalate	100%	✓	□
Dimethyl amine	100%	✓	-
Dimethyl formalde	100%	✓	✓
Dyetyl phthalate	100%	□	□
Dioxane	100%	□	□
Distilled water	100%	✓	✓
Ethanolamine	100%	✓	-
Ethyl acetate	100%	□	×
Ethyl alcohol	>95%	✓	✓
Ethyl chloride	100%	×	×
Ethylene chloride	100%	□	□
Ethylene glycol	100%	✓	✓
Formaldehyde	40%	✓	-
Formic acid	10%	✓	✓
Formic acid	100%	✓	×
Formic acid anhydrous	Sol	✓	□
Fructose		✓	✓
Fruit juice		✓	✓
Gasoline, petrol		×	×
Gelatine		✓	✓
Glucose	20%	✓	✓
Glycerine	100%	✓	✓
Glycolic acid	30%	✓	-
Heptane	100%	□	×
Hexano	100%	✓	□
Hydrobromic acid	>48%	✓	-
Hydrochloric acid	2-7%	✓	✓
Hydrochloric acid	10-20%	✓	✓
Hydrochloric acid	30%	✓	□
Hydrochloric acid	35-36%	✓	-
Hydrofluoric acid	Dil.sol	✓	-
Hydrofluoric acid	40%	✓	-
Hydrogen	100%	✓	-
Hydrogen chloride, dry gas	100%	✓	✓
Hydrogen peroxide	>10%	✓	-
Hydrogen peroxide	>30%	✓	□
Hydrogenic sulphide, dry gas	100%	✓	✓
Iodune in alcohol		✓	-
Isopropyl alcohol	100%	✓	✓

CHEMICAL	CONCENTRATION	20°C	60°C
Isopropyl ether	100%	✓	-
Isoctane	100%	□	×
Lactic acid	>90%	✓	✓
Lanoline		✓	□
Linseed oil		✓	✓
Magnesium carbone	Sat.sol	✓	✓
Magnesiou chloride	Sat.sol	✓	✓
Magnesium sulphate	Sat.sol	✓	✓
Malic acid	Sol	✓	✓
Mercury III chloride	Sat.sol	✓	✓
Mercury III cyanide	Sat.sol	✓	✓
Mercury II nitrate	Sol	✓	✓
Mercury	100%	✓	✓
Methyl acetate	100%	✓	✓
Methyl alcohol	5%	✓	□
Methyl amine	>32%	✓	-
Methyl bromide	100%	×	×
Methyl ether ketone	100%	✓	×
Methylene chloride	100%	□	×
Milk	100%	✓	✓
Monochloroacetic acid	>85%	✓	✓
Naphtha		✓	×
Nickel chloride	Sat.sol	✓	✓
Nickel nitrate	Sat.sol	✓	✓
Nickel sulphate	Sat.sol	✓	✓
Nitric acid	10%	✓	×
Nitric acid	30%	✓	-
Nitric acid	40-50%	□	×
Nitric acid (w/ nitrogen dioxide)		×	×
Nitrobenzene	100%	✓	□
Oleis acid	100%	✓	□
Oleum sulphuric acid w/60% SO3)		×	×
Olive oil			✓
Oxalic acid	Sat.sol	✓	□
Oxygen	100%	✓	-
Paraffin oil		✓	□
Peanut oil		✓	✓
Papperming oil		✓	-
Perchloric acid	2N	✓	-
Petroleum ether		□	□
Phenol	5%	✓	✓
Phenol	90%	✓	-
Phosphoric acid	25%	✓	✓
Phosphoric acid	25-85%	✓	✓
Phosphoric oxychlorido	100%	□	-
Piric Acid	Sat.sol	✓	-
Potassium bicarbonate	Sat.sol	✓	✓

CHEMICAL	CONCENTRATION	20°C	60°C
Potassium borate	Sat.sol	✓	✓
Potassium bromate	>10%	✓	✓
Potassium Bromide	Sat.sol	✓	✓
Potassium carbonate	Sat.sol	✓	-
Potassium chlorate	Sat.sol	✓	✓
Potassium chloride	Sat.sol	✓	-
Potassium chromate	Sat.sol	✓	✓
Potassium cyanide	Sol	✓	-
Potassium fluoride	Sat.sol	✓	✓
Potassium hydroxide	>50%	✓	✓
Potassium iodide	Sat.sol	✓	-
Potassium nitrate	Sat.sol	✓	✓
Potassium perchlorate	10%	✓	✓
Potassium permanganate	2N	✓	-
Potassium persulphate	Sat.sol	✓	-
Potassium sulphate	Sat.sol	✓	-
Propane	100%	✓	-
Propionic acid	>50%	✓	-
Pyridine	100%	□	-
Sea water			✓
Silicone oil			✓
Silver nitrate	Sat.sol	✓	✓
Sodium acetate	Sat.sol	✓	✓
Sodium benzoate	35%	✓	-
Sodium carbonate	>50%	✓	✓
Sodium chlorate	Sat.sol	✓	-
Sodium chloride	Sat.sol	✓	✓
Sodium chlorite	2%	✓	□
Sodium chlorite	20%	✓	□
Sodium dichromate	Sat.sol	✓	✓
Sodium hydrogen carbonate	Sat.sol	✓	✓
Sodium hydrogen sulphate	Sat.sol	✓	✓
Sodium hydrogen sulphite	Sol	✓	-
Sodium hydroxide	1%	✓	✓
Sodium hydroxide	10-60%	✓	✓
Sodium hypochlorite	5%	✓	-
Sodium hypochlorite	10%	✓	-
Sodium hypochlorite	20%	✓	-
Sodium metaphosphate	Sol	✓	-
Sodium nitrate	Sat.sol	✓	✓
Sodium perborate	Sat.sol	✓	-
Sodium phosphate (neutral)	Sat.sol	✓	✓
Sodium silicate	Sol	✓	✓
Sodium sulphate	Sat.sol	✓	✓
Sodium sulphide	Sat.sol	✓	-
Sodium sulphite	40%	✓	✓
Sodium thiosulphate	Sat.sol	✓	-

CHEMICAL	CONCENTRATION	20°C	60°C
Soybean oil		✓	□
Succinic acid	Sat.sol	✓	✓
Stannous chloride (IV)	Sat.sol	✓	✓
Stannous chloride (II)	Sat.sol	✓	✓
Sulphur acid	>10%	✓	✓
Sulphur dioxide, dry or wet	100%	✓	✓
Sulphur acid	10-30%	✓	✓
Sulphuric acid	50%	✓	□
Sulphuric acid	96%	✓	□
Sulphuric acid	98%	□	×
Sulphurous acid	Sol.	✓	-
Tartaric acid	10%	✓	✓
Tetrahydrofuran	100%	□	×
Tetralin	100%	×	×
Thiophene	100%	✓	□
Toluene	100%	□	×
Trichloroacetic acid	>50%	✓	✓
Trichloroethylene	100%	×	×
Triethanolamine	sol	✓	-
Turpentine		×	×
Urea	Sat.sol	✓	-
Vinegar		✓	✓
Water brackish, mineral, potable		✓	✓
Whiskey		✓	-
Wines		✓	-
Xylene	100%	×	×
Yeast	Sol	✓	✓
Zinc chloride	Sat.sol	✓	✓
Zinc sulphate	Sat.sol	✓	✓

ABBREVIATIONS

- Sat.sol** Saturated aqueous solution, prepared at 20°C
Sol Aqueous solution at concentration higher than 10%, but not saturated
Dil.sol Dilute aqueous solution at concentration equal to or lower than 10%
 ✓ Satisfactory
 □ Limited
 × Not satisfactory

INSTALLATION GUIDELINES

GENERAL RECOMMENDATIONS

Before starting to work with HELIROMA's products it is very important to read the technical catalogue:

- HELIROMA's systems have to be assembled according to HELIROMA's instructions;
- For applications or conditions not mentioned, make sure to obtain HELIROMA's technical approval;
- All regulations and directives have to be fulfilled on designing and installation phases;
- Product warranty is valid only for HELIROMA's products.

PREPARATION AND ASSEMBLY

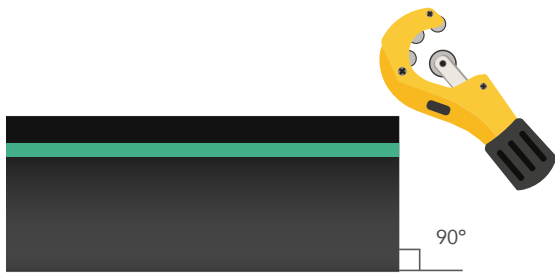

1) Cutting: Pipes are produced in various lengths with one or two sockets and with plain pre-beveled ends.

If cutting to length is needed, use only proper cutting tools for plastic pipes (manual or mechanical) and cut the pipe to desired length at right angle, perpendicular to the pipe axis.

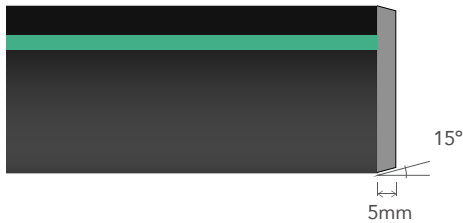

2) Calibration and chamfering: Calibrate and chamfer the pipe end with an angle of approximately 15° with bevel length of about 5 mm;



3) Lubrication: Remove chips, shavings and sawdust before installing; Check the position and integrity of the lip seal in the socket gasket slot. Clean the seal and the socket and apply a thin layer of lubricant around the plain pipe end;

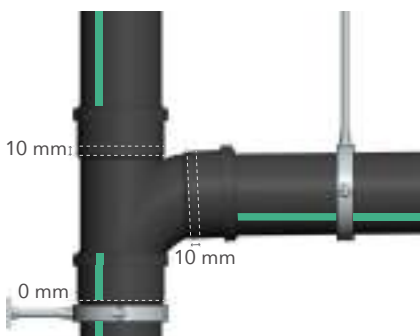

4) Inserting the fitting: Fittings should be inserted to maximum socket depth whereas pipes, after being pushed completely into the socket, have to be pulled back of approximately 10 mm;

FIXING TECHNIQUES

For anchoring Ultra Silent™ system to walls and ceiling use steel brackets with rubber inserts approved for acoustic insulation systems.

As a general rule, straight lengths of pipe must be anchored by mean of fixed point brackets under each socket while the rest of the pipework and the fittings will be supported by sliding point brackets.

The Maximum distances between the brackets for horizontal and vertical installation are shown in the table below.

Fixed Clamp (FP): The first of the two clamps should be installed at the lower third of the floor height of each floor, just below the pipe or fitting socket, and must be fully tightened.

Sliding Clamp (MP): Should be mounted at the upper third of the floor height of each floor. The clamp should lightly press the pipe against the rubber rather than being closed tightly, to reduce the vibration intensity passed to the constructive elements.

DISTANCE BETWEEN CLAMPS		
PIPE DIAMETER	MAX. CLAMP DISTANCE FOR HORIZONTAL INSTALLATION - D1 MAX	MAX. CLAMPS DISTANCE FOR VERTICAL INSTALLATION - D MAX
(mm)	(mm)	(mm)
32	0,80	1,50
40	0,80	1,50
50	0,80	1,50
75	1,10	2,00
90	1,40	2,00
110	1,65	2,00
125	1,85	2,00
160	2,40	2,00
200	2,40	2,00

SIZING CLAMPS		
PIPE DIAMETER	HANGING DISTANCE FROM THE CEILING (L)	CEILING ROD DIAMETER
(mm)	(mm)	(")
110, 125, 160, 200	Up to 0,7 meters	3/8"
	Over 0,7 meters	1/2"
	Up to 2,5 meters	
	Over 2,5 meters	3/4"

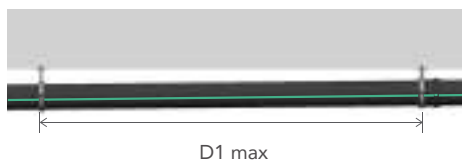

a) horizontal installation

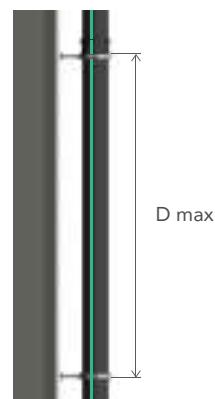

b) vertical installation

INSTALLATION EXAMPLE Ø 110

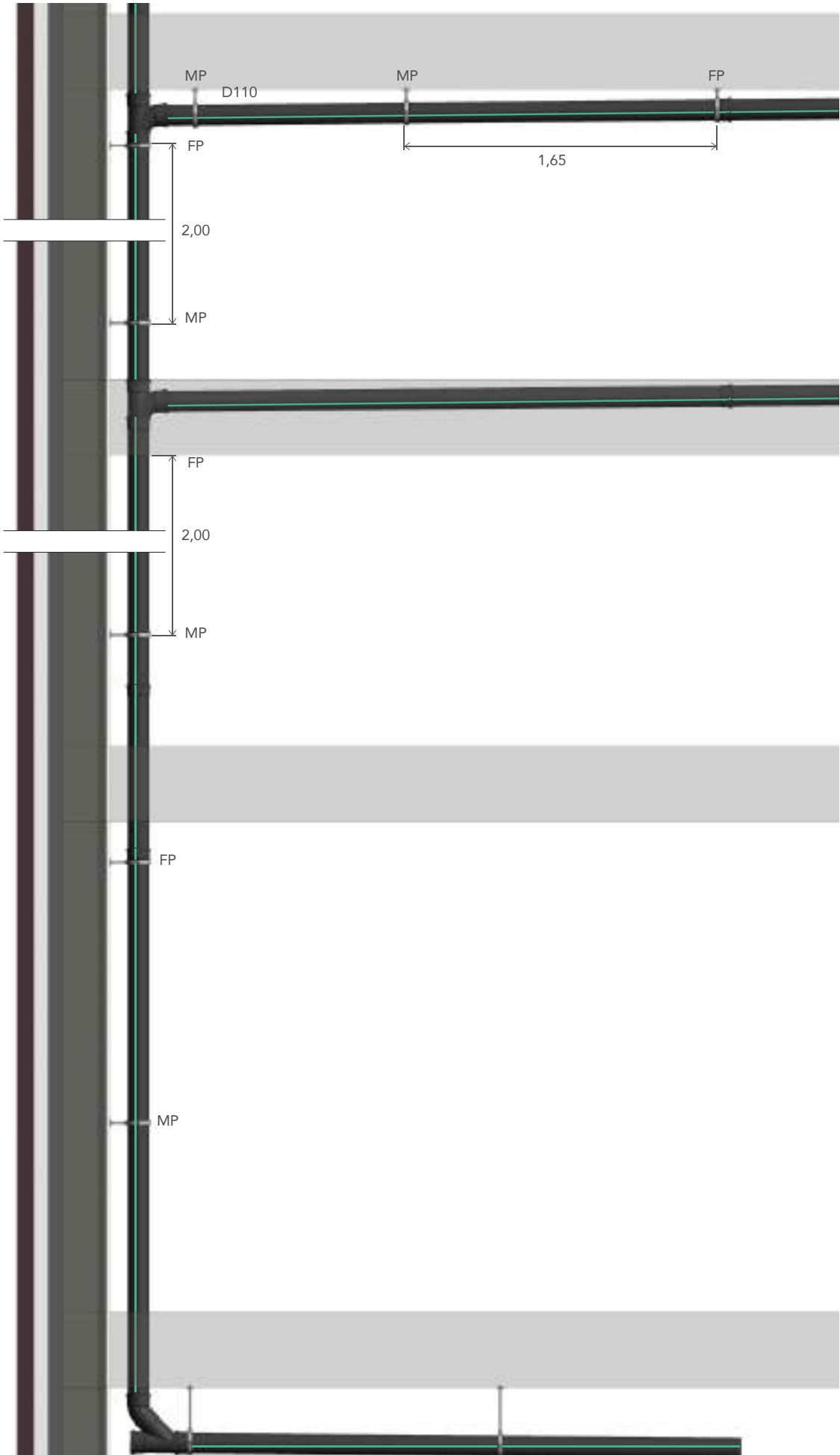

Note: dimensions in meters.

INSTALLATION THROUGH CEILINGS, FLOORS AND WALLS

It is important in acoustic insulated systems to avoid contact between system components and rigid elements, such as walls, ceilings, floors etc., in order to prevent structure-borne noise transmission.

For pipes traversing walls and ceilings, a space of at least 30 mm should be maintained between the pipe and any rigid material.

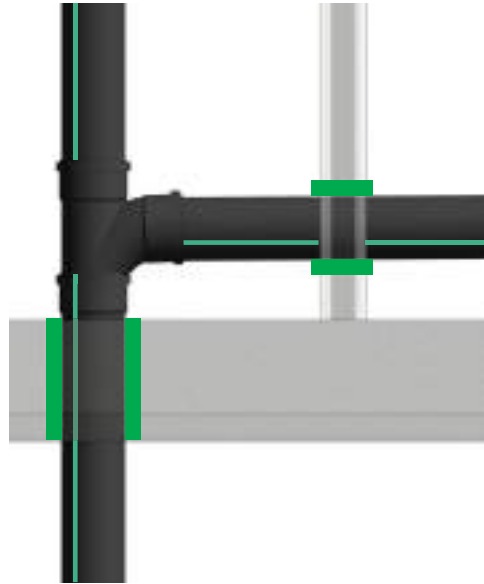

Figure 1

If the spaces around the pipes traversing walls and floors must be filled, use only soft construction materials such as foam or glass fiber (Figure 1).

In case of pipes traversing floors where protection against humidity is needed we recommend the use of Huliote Ultraseal.

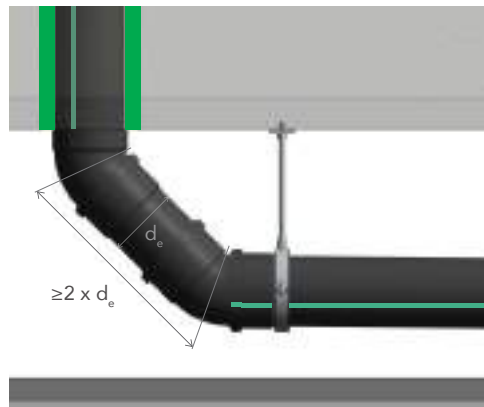

Figure 2

For improved hydraulic flow and reduced noise, 87° bends are not recommended to be used for changing flow direction from vertical to horizontal. It is preferable to use two 45° bends, with $2 \times d_e$ minimum length of connecting pipe between them (Figure 2).

When installing pipes in open spaces (such as basements, parking garages etc.), above suspended ceilings or behind screen walls, prevent any contact of other material (such as suspended ceiling, electrical, water, ventilation and air conditioning systems etc.) with the pipes.

REPAIRS AND INSTALLATION

To add a branch (USEA) to an existing pipe with long socket (USTL) and sleeve (USU), insert the long socket plain end into the branch socket, cut the equivalent of the socket length from the existing pipe piece. Insert the long socket into the upper pipe all the way. Fix the sleeve on the lower pipe and slide the branch and long socket down into the sleeve (Figure 3).

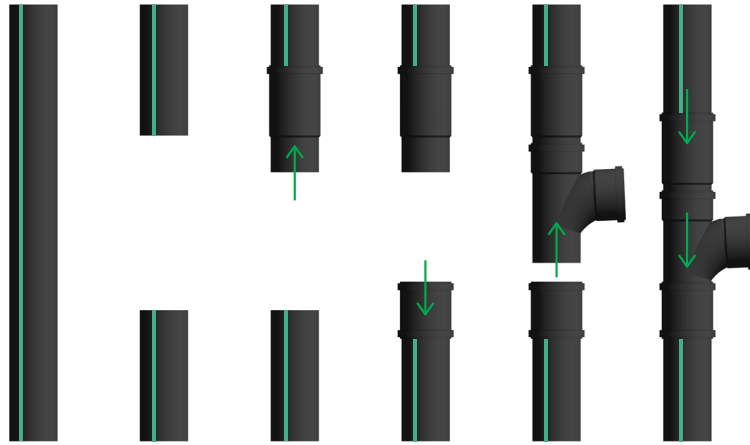

Figure 3

The same methods can be applied for fixing punctured pipes and inserting inspections or other fittings.

An alternative possibility is to use two sleeves and plain pipe (the minimum plain pipe length must be more than double that of the external pipe diameter d_e , as in Figure 4).

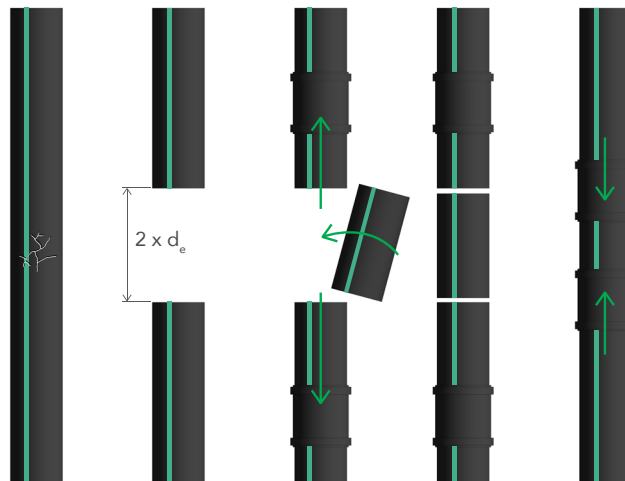

Figure 4

All repairs and insertions should comply with the installation guidelines.

TRANSPORT AND STORAGE

It is recommended to handle the pipes and fittings in their original sales packaging to protect them and prevent damage during loading and transporting.

Load and transport pipes in straight, horizontal position with the full length supported (note that the sockets are unencumbered all around), avoid extreme pressure on the pipes (straps or other heavy materials).

Unload and handle pipes carefully and lay them in a straight, horizontal position (pay attention to positioning of the sockets), on a smooth surface.

Some sizes of pipes and all fittings are packed in carton boxes. Protect them from rain and moisture and store them in a dry place.

It is recommended to store the pipes and fittings in their original sales packaging to protect them from damages.

Ultra Silent™ pipes are UV protected and can be stored outdoor for up to 3 years (depending on geographical location). The gasket material can withstand outdoor storage for up to 3 years and after this period must be replaced before installing.

When using mechanical tools and machines (forklifts, cranes etc.) extra caution should be taken to prevent damages to the products.

Optical defects (external scratches and pigment changes etc.) have no influence on the quality and/or functionality of the system.

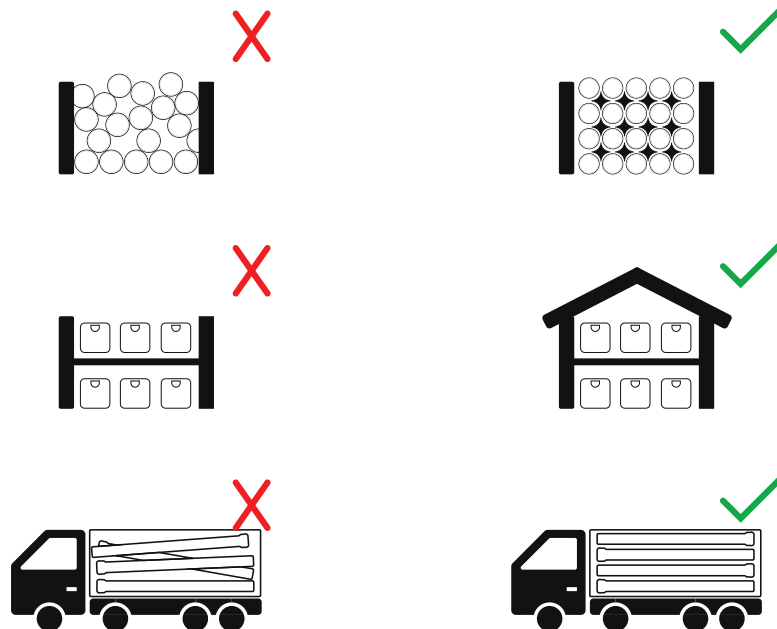

SYSTEM FEATURES

Ultra silent™ pipes are the result of the combination of three layers. The intermediate layer of high density polypropylene based mix with minerals provides excellent mechanical characteristics granting excellent soundproofing performance.

Ultra Silent™ push-fit drainage piping system is suitable for the transportation of waste waters with pH values from 2 to 12 and operation temperatures of 95°C continuously.

The continuous innovative development of piping systems for wastewater and drainage lead to the production of the Ultra Silent™ piping System certified by SKZ, DiBt, DTI, AENOR, WaterMark and SII.

The highest quality available in all manufactured products have given Ultra Silent™ piping system the Green Label which ensures that the production follows environmentally-friendly technologies and methodologies.



Offers its customers a comprehensive range of products for various uses in all diameters and sizes as required within the asset boundaries. Huliote offers, manufactures, and markets pipes and fittings made of various plastic materials such as PP, PVC, PE-X and PPR.

Huliot's products have decades of reputation as being of the highest quality available. The Company is heavily invested in research, development and manufacturing of new products. All of the Huliot products are manufactured under the supervision of the Standards Institute of Israel (SII). They are compliant with the world's most stringent standards: Germany's Deutsches Institut für Bautechnik (DIBT) and the SKZ laboratories, the Spanish Association for Standardization and Certification (AENOR), Danish technological Institute (DTI) and the Australian Building Codes Board's WaterMark. Huliot is a leader in the Green Construction trend, offering products manufactured using environmentally-friendly production technologies: Improved acoustics in plumbing systems, use of recycled materials etc. Huliot is proud to be Israel's only manufacturer whose products are certified for the Green Label, which was awarded thanks to the development of its piping and fittings product lines – UltraSilent™, UltraBeton™, UltraSWG™, piping and fittings for wastewater: SmartLock™ and Tavrig+.

SUSTAINABILITY

HELIROMA is a company future-oriented that has its production process and products aligned with sustainability and energy efficiency guidelines and best practices, fulfilling all ecological and environmental standards.

All raw materials used on the production of pipes and fittings are controlled with several tests in different laboratories to ensure that nothing harmful is ever put into our final product.

Pipes and fittings made of polypropylene have a service life of more than 50 years, rarely need maintenance or extensive repairs, it does not generate disposal waste.

Furthermore, polypropylene is an environmentally friendly material, fully recyclable and can be re-used in other applications on different areas.



WARRANTY

All supplied products by HELIROMA installed according to all procedures in the HELIROMA catalogue, have a 10-year warranty against manufacturing defects.

For further information, consult the general terms and conditions.

ULTRA SILENT™ FITTINGS

ACOUSTICCLAMP™

HULIOT ACOUSTIC CLAMP FOR PERFECT ULTRA SILENT™ INSTALLATION

- Structured rubber profile with hollow sections for maximal pipe grip and minimal vibration intensity passed to the constructive elements;
- Easy and simple clamp fastening by a single screw on only one side;
- EPDM rubber body with air ducts for vibration prevention;
- Rubber softness level: 25 ± 5 shore;

Acoustic Clamp™ Assembly instructions

- Use Huliote acoustic clamps or equivalent products only;
- It is advisable to install the clamps on external walls only. Installation on interior walls will adversely affect acoustic performance;
- It is recommended to install the clamps around the head of the connection for a better grip;



PRESSURECLAMP™

PRESSURE CLAMP™ CONNECTOR FOR PERFECT ULTRA SILENT™ INSTALLATION

- Pressure resistance up to 6 BAR;
- Pipe movement lock;

Pressure Clamp™ Applications

- Parking lot ceilings;
- Exposed rainwater pipes;
- Blind pipes for sewage drainage;

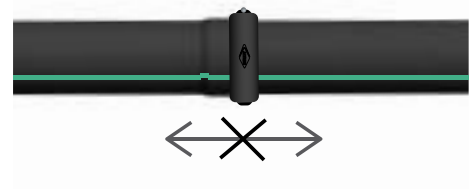

PRESSURE END CAP FOR SEALING PIPELINE END



End Lock™ Assembly instructions

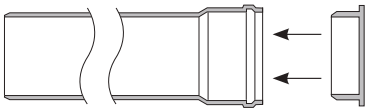

Connect the end cap to the pipe or fitting opening to be plugged

Ensure the presence of a gasket on the pipe or fitting to which the end cap is to be connected;

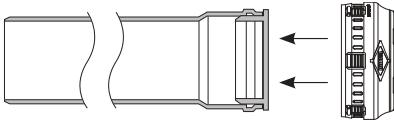

Connect the Endlock™ connector to the pipe or fitting end cap

Make sure the clips are in place and that the Endlock™ is properly aligned;

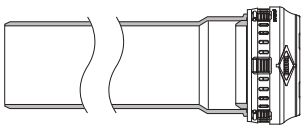

Tighten the metal band

LOCKSEAL™

NEW UPGRADED AND SHORTENED LOCK SEAL™, FOR EASY AND SIMPLE INSTALLATION

Lock Seal™ Applications

When Installing pipes in concrete the use of Lock Seal™ :

- Protects the push-fit connections against vibrations generated during concrete pouring;
- Protects the push-fit connections against lift forces generated during concrete drying;
- Prevents the concrete slurry from infiltrating to the gasket and interfering with proper sealing;

Lock Seal™ Advantages

- Easy and fast assembly;
- Increased safety;
- Tool-free installation;

Lock Seal™ Assembly instructions



1) Assemble the narrow part of the Lock Seal™ socket to the extremity of the pipe or the socket



2) Insert the plain end of the fitting or pipe into the socket (normal push-fit connection method)



3) Slide down the Lock Seal™ until it is properly aligned and the clips settle down in the socket to complete the installation



*To facilitate the assembly, it is recommended to use Huliote's pipe lubricant.



*For disassembly, open the clips to pull the Lock Seal™ off

Lockseal™ is designed for use with PP pipes resilient to hydrostatic pressure and with annular strength suitable for concrete casting.

ULTRASEAL™

Ultra Seal™ System

Ultraseal provides the ideal solution for preventing the structure-borne noise created between wastewater pipes and solid construction.

Ultraseal prevents moisture transition between floors at the pipe borehole.

Ultraseal integrates a thin, highly flexible, waterproof geotextile membrane for perfect adherence to sealants and bituminous cement.

Ultra Seal™ Advantages

- Strong elastic gasket;
- Fast, simple assembly;
- No special tools or equipment required;
- Elastic, flexible, durable;
- Geotextile membrane meets European standards for wet rooms.

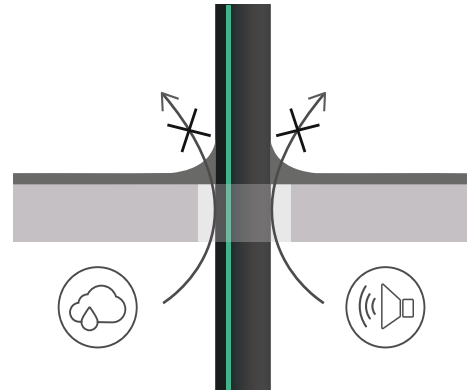

Ultra Seal™ Assembly instructions



1) Assembled on the pipe and placed in the pipe borehole;



3) Second insulating layer



2) Initial insulating layer (primer);



4) Final insulating layer



5) Filling and coating layer



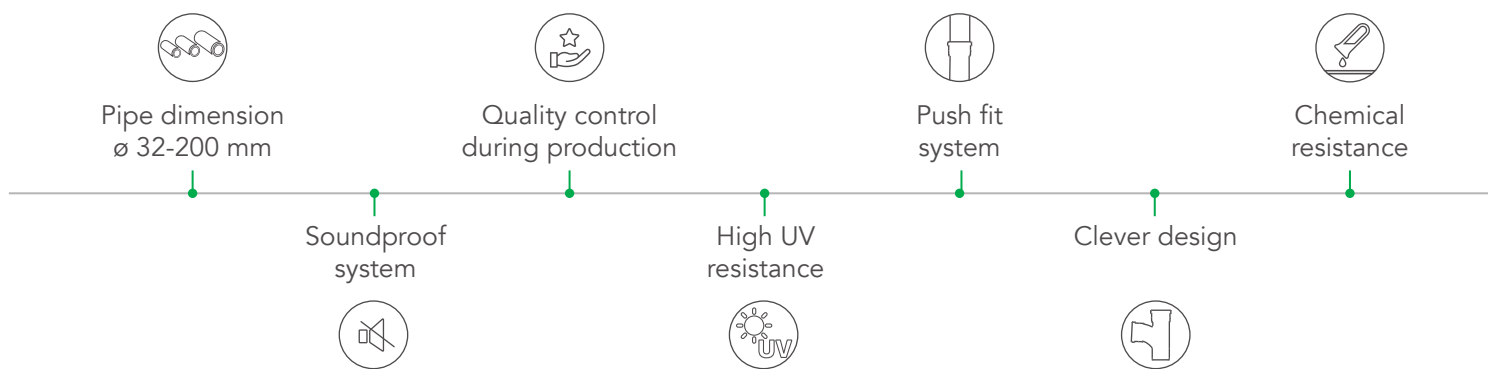

SYSTEM GENERAL ADVANTAGES

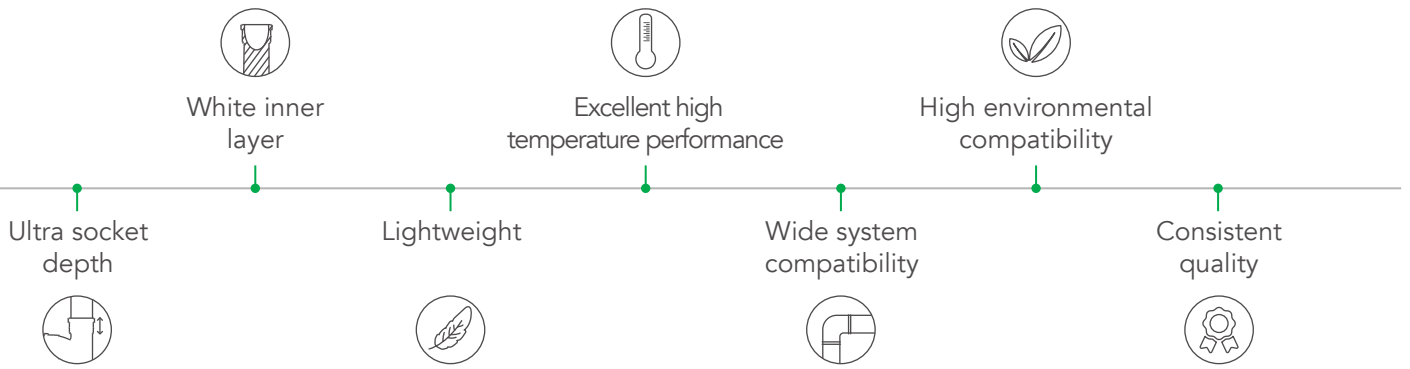

CERTIFICATIONS

Ultra Silent™ piping systems comply with the following national and international standards and regulations.

The highest quality of Ultra Silent™ pipes and fittings is checked regularly through several tests during production and in the laboratory.

STANDARDS:

EN 1451-1: Polypropylene (PP) piping systems for soil and waste discharge (low and high temperature) within the building structure.

EN 13501-1: Fire classification of construction products and building elements - Classification using data from reaction to fire tests.

DIN 4102-2: Fire Behaviour of Building Materials and Building Components; Building Components; Definitions, Requirements and Tests.

EN 14366: Laboratory measurement of noise from wastewater installations.

ISO 7671: Plastics piping systems for soil and waste discharge (low and high temperature) inside buildings - Polypropylene.

HR 3.43: Drainage and Sewerage Pipes and Fittings made of PP with Mineral Modifiers within the Building Structure.

SI 14020: Environmental Labels and Declarations – General Principles, the requirements set in the specific relevant standards, and by the Green Label Board.

SII procedure 004: Rules for the Granting of the Green Label for Products with Reduced Environmental Impact.

ISO 9001: Quality management systems.

ISO14001: Environmental management systems.

ISO 45001: Occupational health and safety management.



ULTRA SILENT | PRODUCT RANGE

- ULTRA SILENT PIPES
- ULTRA SILENT FITTINGS

USEM SINGLE SOCKET PIPE

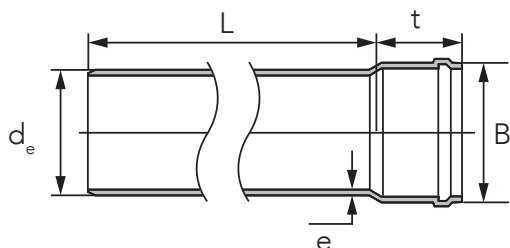

CHARACTERISTICS

SUPPLIED IN	3 m bars
TYPE OF CONNECTION	Push fit
SERIES	16
STANDARDS	EN 1451-1 ISO 7671 HR 3.43

REFERENCE	d _e OUTSIDE DIAMETER	DN	e ^e THICKNESS	d _i INSIDE DIAMETER	L	B	t	BOX	PALLET
	(mm)							(un)	
HL5753200015*	32	30	1,8	28,4	150	45	42	20	1440
HL5753200025*	32	33	1,8	28,4	250	45	42	20	960
HL5753200050*	32	33	1,8	28,4	500	45	42	20	480
HL5753200100*	32	33	1,8	28,4	1000	45	42	15	300
HL5753200150*	32	33	1,8	28,4	1500	45	42	15	300
HL5753200200*	32	33	1,8	28,4	2000	45	42	15	300
HL5753200300	32	33	1,8	28,4	3000	45	42	15	300
HL5754000015*	40	40	1,8	36,4	150	55	44	20	1440
HL5754000025*	40	40	1,8	36,4	250	55	44	20	960
HL5754000050*	40	40	1,8	36,4	500	55	44	20	480
HL5754000100*	40	40	1,8	36,4	1000	55	44	15	420
HL5754000150*	40	40	1,8	36,4	1500	55	44	15	420
HL5754000200*	40	40	1,8	36,4	2000	55	44	15	420
HL5754000300	40	40	1,8	36,4	3000	55	44	15	420

CONTINUED >

CONTINUED >

REFERENCE	d _e OUTSIDE DIAMETER	DN	e THICKNESS	d _i INSIDE DIAMETER	L	B	t	BOX	PALLET
			(mm)					(un)	
HL5755000015*	50	50	1,8	46,4	150	65	46	20	960
HL5755000025*	50	50	1,8	46,4	250	65	46	20	540
HL5755000050*	50	50	1,8	46,4	500	65	46	20	400
HL5755000100*	50	50	1,8	46,4	1000	65	46	15	270
HL5755000150*	50	50	1,8	46,4	1500	65	46	15	270
HL5755000200*	50	50	1,8	46,4	2000	65	46	15	270
HL5755000300	50	50	1,8	46,4	3000	65	46	15	270
HL5757500015*	75	70	2,3	70,4	150	90	49	20	360
HL5757500025*	75	70	2,3	70,4	250	90	49	20	240
HL5757500050*	75	70	2,3	70,4	500	90	49	20	160
HL5757500100*	75	70	2,3	70,4	1000	90	49	10	120
HL5757500150*	75	70	2,3	70,4	1500	90	49	10	120
HL5757500200*	75	70	2,3	70,4	2000	90	49	10	120
HL5757500300*	75	70	2,3	70,4	3000	90	49	10	120
HL5759000015*	90	90	2,8	84,4	150	107	54	20	240
HL5759000025*	90	90	2,8	84,4	250	107	54	20	160
HL5759000050*	90	90	2,8	84,4	500	107	54	10	120
HL5759000100*	90	90	2,8	84,4	1000	107	54	10	100
HL5759000150*	90	90	2,8	84,4	1500	107	54	10	100
HL5759000200*	90	90	2,8	84,4	2000	107	54	10	100
HL5759000300	90	90	2,8	84,4	3000	107	54	10	100
HL5751100015*	110	100	3,4	103,2	150	130	65	20	180
HL5751100025*	110	100	3,4	103,2	250	130	65	20	180
HL5751100050*	110	100	3,4	103,2	500	130	65	10	80
HL5751100100*	110	100	3,4	103,2	1000	130	65	10	80
HL5751100150*	110	100	3,4	103,2	1500	130	65	10	80
HL5751100200*	110	100	3,4	103,2	2000	130	65	10	80
HL5751100300	110	100	3,4	103,2	3000	130	65	10	80
HL5751200015*	125	125	3,9	117,2	150	149	72	10	120
HL5751200025*	125	125	3,9	117,2	250	149	72	6	108
HL5751200050*	125	125	3,9	117,2	500	149	72	6	72
HL5751200100*	125	125	3,9	117,2	1000	149	72	8	80
HL5751200150*	125	125	3,9	117,2	1500	149	72	8	80
HL5751200200*	125	125	3,9	117,2	2000	149	72	8	80
HL5751200300	125	125	3,9	117,2	3000	149	72	8	80
HL5751600015*	160	150	4,9	150,2	150	186	75	8	96
HL5751600025*	160	150	4,9	150,2	250	186	75	8	48
HL5751600050*	160	150	4,9	150,2	500	186	75	8	32
HL5751600100*	160	150	4,9	150,2	1000	186	75	6	24
HL5751600150*	160	150	4,9	150,2	1500	186	75	6	24
HL5751600200*	160	150	4,9	150,2	2000	186	75	6	24
HL5751600300	160	150	4,9	150,2	3000	186	75	6	24
HL5752000100*	200	200	6,2	187,6	1000	228	108	1	16

* Available on demand.

USDM DOUBLE SOCKET PIPE

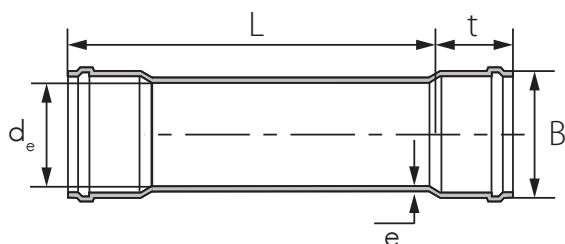

CHARACTERISTICS

SUPPLIED IN	3 m bars
TYPE OF CONNECTION	Push fit
SERIES	16
STANDARDS	EN 1451-1 ISO 7671 HR 3.43

REFERENCE	d _e OUTSIDE DIAMETER	DN	e THICKNESS	d _i INSIDE DIAMETER	L	B	t	BOX	PALLET
			(mm)					(un)	
HL5753232050*	32	30	1,8	28,4	500	45	42	20	240
HL5753232100*	32	30	1,8	28,4	1000	45	42	15	300
HL5753232150*	32	30	1,8	28,4	1500	45	42	15	300
HL5753232200*	32	30	1,8	28,4	2000	45	42	15	300
HL5753232300*	32	30	1,8	28,4	3000	45	42	15	300
HL5754040050*	40	40	1,8	36,4	500	55	44	20	240
HL5754040100*	40	40	1,8	36,4	1000	55	44	15	420
HL5754040150*	40	40	1,8	36,4	1500	55	44	15	420
HL5754040200*	40	40	1,8	36,4	2000	55	44	15	420
HL5754040300*	40	40	1,8	36,4	3000	55	44	15	420
HL5755050050*	50	50	1,8	46,4	500	65	46	20	240
HL5755050100*	50	50	1,8	46,4	1000	65	46	15	270
HL5755050150*	50	50	1,8	46,4	1500	65	46	15	270
HL5755050200*	50	50	1,8	46,4	2000	65	46	15	270

CONTINUED >

CONTINUED >

REFERENCE	de OUTSIDE DIAMETER	DN	e THICKNESS	di INSIDE DIAMETER	L	B	t	BOX	PALLET
			(mm)					(un)	
HL5755050300*	50	50	1,8	46,4	3000	65	46	15	270
HL5757575050*	75	70	2,2	70,4	500	90	49	20	120
HL5757575100*	75	70	2,2	70,4	1000	90	49	10	120
HL5757575150*	75	70	2,2	70,4	1500	90	49	10	120
HL5757575200*	75	70	2,2	70,4	2000	90	49	10	120
HL5757575300*	75	70	2,2	70,4	3000	90	49	10	120
HL5759090050*	90	90	2,8	84,4	500	107	54	10	90
HL5759090100*	90	90	2,8	84,4	1000	107	54	10	100
HL5759090150*	90	90	2,8	84,4	1500	107	54	10	100
HL5759090200*	90	90	2,8	84,4	2000	107	54	10	100
HL5759090300*	90	90	2,8	84,4	3000	107	54	10	100
HL5751111050*	110	110	3,4	103,2	500	130	65	10	60
HL5751111100*	110	110	3,4	103,2	1000	130	65	10	80
HL5751111150*	110	110	3,4	103,2	1500	130	65	10	80
HL5751111200*	110	110	3,4	103,2	2000	130	65	10	80
HL5751111300*	110	110	3,4	103,2	3000	130	65	10	80
HL5751212050*	125	125	3,9	117,2	500	149	72	6	54
HL5751212100*	125	125	3,9	117,2	1000	149	72	8	80
HL5751212150*	125	125	3,9	117,2	1500	149	72	8	80
HL5751212200*	125	125	3,9	117,2	2000	149	72	8	80
HL5751212300*	125	125	3,9	117,2	3000	149	72	8	80

* Available on demand.



ULTRA SILENT FITTINGS

USB BEND 15°

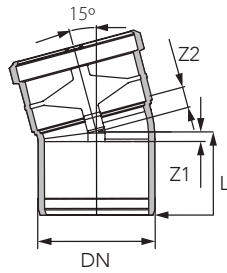

CHARACTERISTICS

COLOUR	Black
RAW MATERIAL	PP-MD
TYPE OF CONNECTION	Push Fit
SERIES	16
STANDARDS	EN 1451-1 ISO 7671 HR 3.43
COMPATIBLE SYSTEMS	ULTRA SILENT

REFERENCE	DN	L	Z1	Z2	BOX	PALLET
		(mm)			(un)	
HL7070000170*	32	44,5	4	9,0	50	3000
HL7070010170*	40	51,5	4	10,0	40	2400
HL7070020170*	50	56,5	5	11,0	40	1200
HL7070030170*	75	63,5	7	14,0	20	600
HL7070090170*	90	68,0	8	16,0	20	480
HL7070040170*	110	78,0	6	19,0	20	240
HL7070050170*	125	87,0	12	21,9	10	160
HL7070060170*	160	99,0	8	22,0	5	80

* Available on demand.

USB BEND 30°

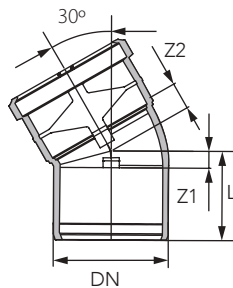

CHARACTERISTICS

COLOUR	Black
RAW MATERIAL	PP-MD
TYPE OF CONNECTION	Push Fit
SERIES	16
STANDARDS	EN 1451-1 ISO 7671 HR 3.43
COMPATIBLE SYSTEMS	ULTRA SILENT

REFERENCE	DN	L	Z1	Z2	BOX	PALLET
		(mm)			(un)	
HL7070000370*	32	47,5	5	10,0	50	3000
HL7070010370*	40	54,5	7	13,0	40	2400
HL7070020370*	50	59,5	8	14,0	40	1200
HL7070030370*	75	68,5	12	18,0	20	600
HL7070090370*	90	74,0	14	20,5	20	320
HL7070040370*	110	85,0	16	25,5	20	240
HL7070050370*	125	104,0	29	30,0	10	160
HL7070060370*	160	105,0	27	29,0	5	80

* Available on demand.

USB BEND 45°

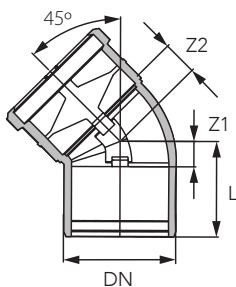

CHARACTERISTICS

COLOUR	Black
RAW MATERIAL	PP-MD
TYPE OF CONNECTION	Push Fit
SERIES	16
STANDARDS	EN 1451-1 ISO 7671 HR 3.43
COMPATIBLE SYSTEMS	ULTRA SILENT

REFERENCE	DN	L	Z1	Z2	BOX	PALLET
		(mm)			(un)	
HL7070000470	32	53,0	8	13,0	40	2400
HL7070010470	40	58,5	11	17,0	40	2400
HL7070020470	50	64,0	13	19,0	40	1200
HL7070030470	75	74,5	18	24,0	20	600
HL7070090470	90	81,0	21	27,5	20	320
HL7070040470	110	94,0	25	33,5	20	240
HL7070050470	125	104,0	29	38,0	10	120
HL7070060470*	160	116,0	36	44,0	5	60
HL7070080470*	200	148,0	49	63,0	3	36

* Available on demand;

USB BEND 67,5°

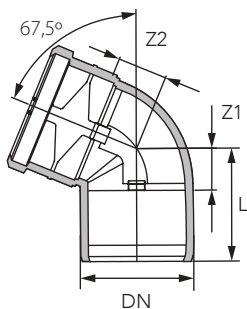

CHARACTERISTICS

COLOUR	Black
RAW MATERIAL	PP-MD
TYPE OF CONNECTION	Push Fit
SERIES	16
STANDARDS	EN 1451-1 ISO 7671 HR 3.43
COMPATIBLE SYSTEMS	ULTRA SILENT

REFERENCE	DN	L	Z1	Z2	BOX	PALLET
		(mm)			(un)	
HL7070000670*	32	58,0	13	18	40	2400
HL7070010670*	40	65,5	18	24	40	1600
HL7070020670*	50	72,5	21	27	40	1200
HL7070030470*	75	85,5	29	35	20	480
HL7070090670*	90	94,0	34	40	20	320
HL7070040670*	110	110,0	44	48	20	240

* Available on demand;

USB BEND 87,5°

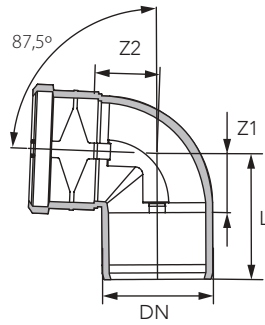

CHARACTERISTICS

COLOUR	Black
RAW MATERIAL	PP-MD
TYPE OF CONNECTION	Push Fit
SERIES	16
STANDARDS	EN 1451-1 ISO 7671 HR 3.43
COMPATIBLE SYSTEMS	ULTRA SILENT

REFERENCE	DN	L	Z1	Z2	BOX	PALLET
(mm)					(un)	
HL7070000870	32	64,0	20,0	24	40	2400
HL7070010870	40	73,5	26,0	32	40	1600
HL7070020870	50	79,5	28,5	35	40	1200
HL7070030870	75	99,5	43,0	49	20	480
HL7070090870	90	110,0	50,0	56	20	320
HL7070040870	110	129,0	60,0	66	20	240
HL7070050870	125	142,0	67,0	73	10	120
HL7070060870*	160	162,0	79,5	81	5	60

* Available on demand;

USEA BRANCH 45°

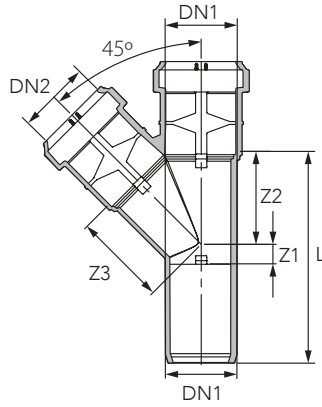

CHARACTERISTICS

COLOUR	Black
RAW MATERIAL	PP-MD
TYPE OF CONNECTION	Push Fit
SERIES	16
STANDARDS	EN 1451-1 ISO 7671 HR 3.43
COMPATIBLE SYSTEMS	ULTRA SILENT

REFERENCE	DN1	DN2	L	Z1	Z2	Z3	BOX	PALLET
(mm)							(un)	
HL7070600470	32	32	95,0	9,0	42,0	42,0	20	1200
HL7070611470	40	40	111,0	11,0	52,0	52,0	20	800
HL7070621470	50	40	129,0	13,0	64,0	57,0	20	600
HL7070622470	50	50	129,0	13,0	64,0	64,0	20	600
HL7070632470	75	50	170,0	18,0	95,0	100,0	20	320
HL7070633470	75	75	170,0	18,0	95,0	95,0	20	320
HL7070691470	90	40	205,0	32,5	112,5	92,0	10	180
HL7070692470	90	50	205,0	32,5	112,5	89,0	10	180
HL7070699470	90	90	206,0	33,0	113,0	112,5	10	120
HL7070641470	110	40	148,5	17,0	112,0	96,5	10	160
HL7070642470	110	50	148,5	17,0	108,0	96,5	10	160
HL7070643470	110	75	184,5	2,0	121,0	113,5	10	120
HL7070649470	110	90	231,0	25,0	137,0	143,0	10	120
HL7070644470	110	110	231,0	25,0	137,0	137,0	8	96
HL7070654470	125	110	238,0	18,0	145,0	149,0	8	96
HL7070655470	125	125	258,0	31,0	152,0	152,0	6	72
HL7070664470*	160	110	284,0	39,0	159,0	169,0	5	60
HL7070666470*	160	160	319,0	39,0	194,0	194,0	3	36
HL7070686470*	200	160	343,0	19,0	213,0	224,0	2	16
HL7070688470*	200	200	399,0	25,0	219,0	226,0	4	16

* Available on demand;

USEA BRANCH 87,5°

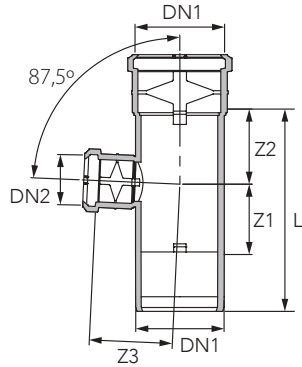

CHARACTERISTICS

COLOUR	Black
RAW MATERIAL	PP-MD
TYPE OF CONNECTION	Push Fit
SERIES	16
STANDARDS	EN 1451-1 ISO 7671 HR 3.43
COMPATIBLE SYSTEMS	ULTRA SILENT

REFERENCE	DN1	DN2	L	Z1	Z2	Z3	BOX	PALLET
(mm)							(un)	
HL7070600870	32	32	94,0	9,0	42	40,0	20	1200
HL7070611870	40	40	64,5	13,0	64	64,0	20	800
HL7070621870	50	40	112,5	32,3	31	62,0	20	600
HL7070622870	50	50	112,5	31,0	30	62,0	20	600
HL7070632870	75	50	170,0	58,0	55	60,0	20	320
HL7070633870	75	75	114,5	58,0	55	55,0	20	320
HL7070692870	90	50	205,0	69,0	76	83,0	10	180
HL7070642870	110	50	137,5	32,0	65	36,5	10	180
HL7070655870	125	125	225,0	78,0	73	72,0	6	120
HL7070666870*	160	160	276,0	97,0	87	144,0	4	160

* Available on demand;

USEA SWEPT BRANCH 87,5°

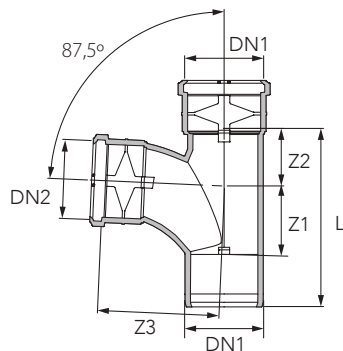

CHARACTERISTICS

COLOUR	Black
RAW MATERIAL	PP-MD
TYPE OF CONNECTION	Push Fit
SERIES	16
STANDARDS	EN 1451-1 ISO 7671 HR 3.43
COMPATIBLE SYSTEMS	ULTRA SILENT

REFERENCE	DN1	DN2	L	Z1	Z2	Z3	BOX	PALLET
(mm)							(un)	
HL7070799870	90	90	205	79	66	97	10	120
HL7070743870	110	75	211	82	60	97	10	120
HL7070749870	110	90	211	82	60	97	10	120
HL7070744870	110	110	211	82	60	97	10	120
HL7070754870	125	110	240	100	65	117	6	72
HL7070764870*	160	110	266	96	84	117	4	48

* Available on demand;

USED CORNER BRANCH 87,5°

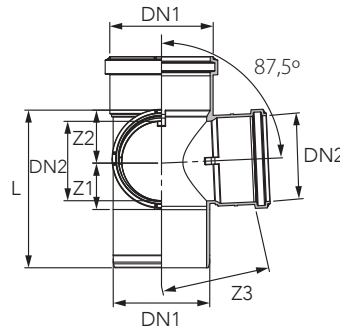

CHARACTERISTICS

COLOUR	Black
RAW MATERIAL	PP-MD
TYPE OF CONNECTION	Push Fit
SERIES	16
STANDARDS	EN 1451-1 ISO 7671 HR 3.43
COMPATIBLE SYSTEMS	ULTRA SILENT

REFERENCE	DN1	DN2	L	Z1	Z2	Z3	BOX	PALLET
	(mm)						(un)	
HL7071244870	110	110	207	82	56	151	6	72
HL7071254870	125	110	207	58	75	140	5	60

USDA DOUBLE BRANCH 67,5°

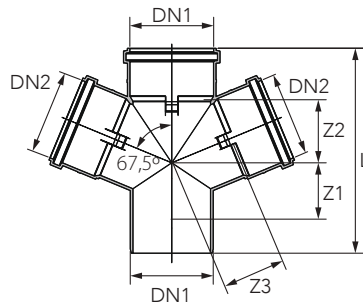

CHARACTERISTICS

COLOUR	Black
RAW MATERIAL	PP-MD
TYPE OF CONNECTION	Push Fit
SERIES	16
STANDARDS	EN 1451-1 ISO 7671 HR 3.43
COMPATIBLE SYSTEMS	ULTRA SILENT

REFERENCE	DN1	DN2	L	Z1	Z2	Z3	BOX	PALLET
	(mm)						(un)	
HL7071042670	110	50	207	17	54	73	8	128
HL7071044670	110	110	272	51	85	85	6	72

USDA DOUBLE BRANCH 87,5°

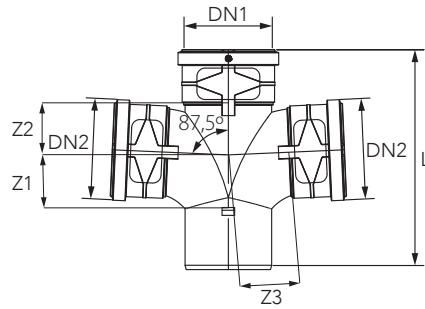

CHARACTERISTICS

COLOUR	Black
RAW MATERIAL	PP-MD
TYPE OF CONNECTION	Push Fit
SERIES	16
STANDARDS	EN 1451-1 ISO 7671 HR 3.43
COMPATIBLE SYSTEMS	ULTRA SILENT

REFERENCE	DN1	DN2	L	Z1	Z2	Z3	BOX	PALLET
	(mm)						(un)	
HL7071042670	110	110	207	82	56	151	6	72

USRE INSPECTION PIPE

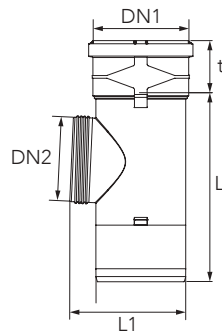

CHARACTERISTICS

COLOUR	Black
RAW MATERIAL	PP-MD
TYPE OF CONNECTION	Push Fit
SERIES	16
STANDARDS	EN 1451-1 ISO 7671 HR 3.43
COMPATIBLE SYSTEMS	ULTRA SILENT

REFERENCE	DN1	DN2	L	L1	t	BOX	PALLET
	(mm)					(un)	
HL7079120070	50	45,0	140	65,0	55	20	800
HL7079130070	75	45,0	140	98,0	71	20	320
HL7079190070	90	77,4	200	129,0	58	10	180
HL7079140070	110	97,0	231	140,0	64	10	120
HL7079150070	125	97,0	222	164,8	73	8	96
HL7079160070*	160	97,0	236	198,4	85	6	72
HL7079180070*	200	97,0	343	231,0	93	2	24

* Available on demand;

USMM DOUBLE SOCKET

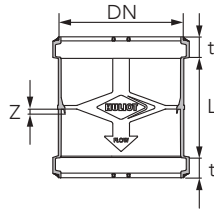

CHARACTERISTICS

COLOUR	Black
RAW MATERIAL	PP-MD
TYPE OF CONNECTION	Push Fit
SERIES	16
STANDARDS	EN 1451-1 ISO 7671 HR 3.43
COMPATIBLE SYSTEMS	ULTRA SILENT

REFERENCE	DN	L	Z	t	BOX	PALLET
		(mm)			(un)	
HL7071700270	32	56,6	2,0	14,3	50	4000
HL7071710270	40	60,0	2,0	14,0	30	1800
HL7071720275	50	64,0	4,0	16,0	20	1200
HL7071730275	75	73,0	6,0	16,4	20	800
HL7071790270	90	85,0	1,4	14,0	20	480
HL7071740275	110	97,0	9,0	17,0	20	320
HL7071750275	125	118,6	10,4	17,0	10	160
HL7071760275*	160	119,0	10,6	23,0	12	144
HL7071780275*	200	135,0	12,0	28,5	2	48

* Available on demand;

USU SLEEVE

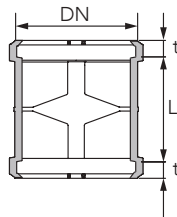

CHARACTERISTICS

COLOUR	Black
RAW MATERIAL	PP-MD
TYPE OF CONNECTION	Push Fit
SERIES	16
STANDARDS	EN 1451-1 ISO 7671 HR 3.43
COMPATIBLE SYSTEMS	ULTRA SILENT

REFERENCE	DN	L	t	BOX	PALLET	
		(mm)			(un)	
HL7071700070*	32	56,6	14,3	50	4000	
HL7071710070*	40	60,0	14,0	30	1800	
HL7071720070*	50	68,0	14,0	20	1200	
HL7071730070*	75	77,0	14,0	20	800	
HL7071790070*	90	85,0	14,0	20	480	
HL7071740070*	110	97,0	17,0	20	320	
HL7071750070*	125	118,6	16,8	10	160	
HL7071760070*	160	131,0	17,0	12	144	
HL7071780070*	200	192,2	28,3	2	48	

* Available on demand;

USLL LONG SOCKET

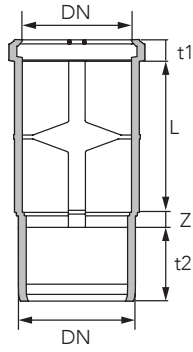

CHARACTERISTICS

COLOUR	Black
RAW MATERIAL	PP-MD
TYPE OF CONNECTION	Push Fit
SERIES	16
STANDARDS	EN 1451-1 ISO 7671 HR 3.43
COMPATIBLE SYSTEMS	ULTRA SILENT

REFERENCE	DN	L	Z	t1	t2	BOX	PALLET
						(un)	
HL7072220070*	50	101,00	6,74	14,1	51,55	20	800
HL7072230070*	75	114,97	9,45	14,1	56,58	20	360
HL7072290070*	90	133,90	13,10	14,1	60,00	20	320
HL7072240070*	110	144,46	14,12	16,6	69,41	15	180
HL7072250070*	125	188,94	15,63	19,1	75,00	12	144
HL7072260070*	160	204,81	20,60	23,1	86,00	6	72

* Available on demand;

USM END CAP

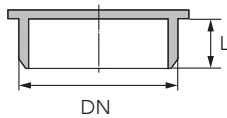

CHARACTERISTICS

COLOUR	Black
RAW MATERIAL	PP-MD
TYPE OF CONNECTION	Push Fit
SERIES	16
STANDARDS	EN 1451-1 ISO 7671 HR 3.43
COMPATIBLE SYSTEMS	ULTRA SILENT

REFERENCE	DN	L	BOX	PALLET
		(mm)	(un)	
HL7071610070	40	44	80	4800
HL7071620070	50	46	80	4800
HL7071630070	75	44	30	1800
HL7071690070	90	59	20	1200
HL7071640070	110	49	20	800
HL7071650070	125	75	20	480
HL7071660070*	160	83	20	240
HL7071680070*	200	65	10	180

* Available on demand;

USR REDUCER

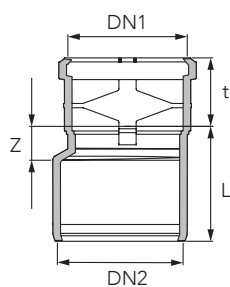

CHARACTERISTICS

COLOUR	Black
RAW MATERIAL	PP-MD
TYPE OF CONNECTION	Push Fit
SERIES	16
STANDARDS	EN 1451-1 ISO 7671 HR 3.43
COMPATIBLE SYSTEMS	ULTRA SILENT

REFERENCE	DN2	DN1	L	Z	t	BOX	PALLET
			(mm)			(un)	
HL7072110070	40	32	48	14	42	30	1800
HL7072120070	50	32	65	15	42	30	1800
HL7072121070	50	40	64	15	42	30	1800
HL7072132070	75	50	85	26	47	20	1200
HL7072191070	90	40	93	35	47	20	800
HL7072192070	90	50	97	34	47	20	800
HL7072193070	90	75	86	24	51,5	20	600
HL7072141070	110	40	122,5	51	43	20	480
HL7072142070	110	50	118	46	47	20	480
HL7072143070	110	75	106	34	52	20	360
HL7072149070	110	90	101	29	55	20	360
HL7072154070	125	110	106	29	64	10	240
HL7072164070*	160	110	137	84	64	10	120
HL7072165070*	160	125	140	74	55	12	144
HL7072186070*	200	160	153	54	80	6	96

* Available on demand;

USSW TECHNICAL BEND / SIPHON CONNECTOR

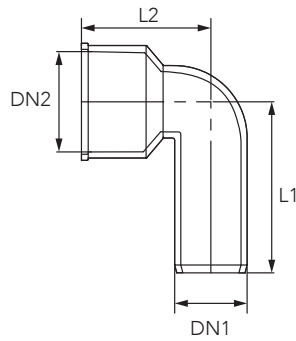

CHARACTERISTICS

COLOUR	Black
RAW MATERIAL	PP-MD
TYPE OF CONNECTION	Push Fit
SERIES	16
STANDARDS	EN 1451-1 ISO 7671 HR 3.43
COMPATIBLE SYSTEMS	ULTRA SILENT

REFERENCE	DN1	DN2	L1	L2	BOX	PALLET
	(mm)				(un)	
HL7074010970	32	46	76	58	40	2400
HL7074021970	40	50	82	56	20	1200
HL7074011970	40	46	76	56	20	1200
HL7074022970	50	50	82	60	20	1200

USS STRAIGHT FITTING / SIPHON CONNECTOR

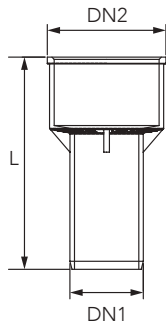

CHARACTERISTICS

COLOUR	Black
RAW MATERIAL	PP-MD
TYPE OF CONNECTION	Push Fit
SERIES	16
STANDARDS	EN 1451-1 ISO 7671 HR 3.43
COMPATIBLE SYSTEMS	ULTRA SILENT

REFERENCE	DN1	DN2	L	BOX	PALLET
	(mm)			(un)	
HL7141760070	32	46	93	40	2400
HL7141761070	40	46	93	40	2400
HL7141721070	40	50	93	40	2400

USSWL LONG TECHNICAL BEND / SIPHON CONNECTOR

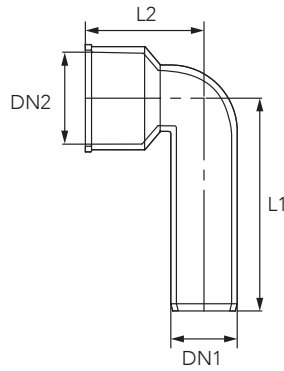

CHARACTERISTICS

COLOUR	Black
RAW MATERIAL	PP-MD
TYPE OF CONNECTION	Push Fit
SERIES	16
STANDARDS	EN 1451-1 ISO 7671 HR 3.43
COMPATIBLE SYSTEMS	ULTRA SILENT

REFERENCE	DN1	DN2	L1	L2	BOX	PALLET
	(mm)			(un)		
HL7074021971	40	50	140	56	20	1200
HL7074011971	40	46	140	57	20	1200

RUBBER GASKET FOR USS, USSW, USSWL



CHARACTERISTICS

COLOUR	Black
RAW MATERIAL	PP-MD
TYPE OF CONNECTION	Push Fit
SERIES	16
STANDARDS	EN 1451-1 ISO 7671 HR 3.43
COMPATIBLE SYSTEMS	ULTRA SILENT

REFERENCE	DN1	DN2	BOX	PALLET
	(mm)		(un)	
HLT047T000000000	26/32	46	500	-
HLT046T000000000	40	46	1000	-
HLT050T000000032	26/32	50	500	-
HLT050T000000040	40	50	500	-

USSBL LONG WC BEND

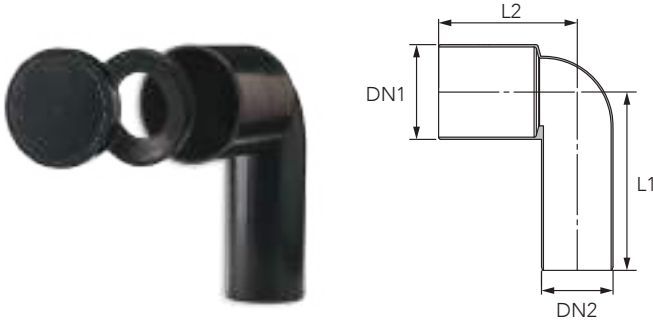

CHARACTERISTICS

COLOUR	Black
RAW MATERIAL	PP-MD
TYPE OF CONNECTION	Push Fit
SERIES	16
STANDARDS	EN 1451-1 ISO 7671 HR 3.43
COMPATIBLE SYSTEMS	ULTRA SILENT

REFERENCE	DN1	DN2	L1	L2	BOX	PALLET
(mm)				(un)		
HL7195000070	119,6	90	175	225	10	120
HL7155000070	119,6	110	185	226	10	120

ACOUSTIC CLAMP

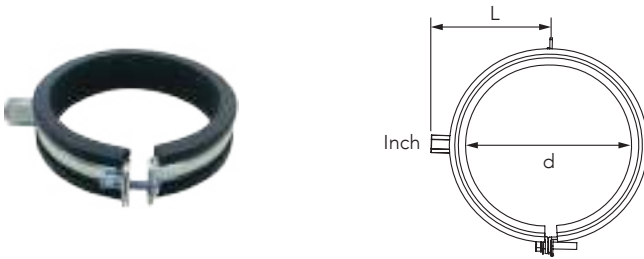

CHARACTERISTICS

COLOUR	Black
RAW MATERIAL	PP-MD
TYPE OF CONNECTION	Push Fit
SERIES	16
STANDARDS	EN 1451-1 ISO 7671 HR 3.43
COMPATIBLE SYSTEMS	ULTRA SILENT

REFERENCE	DN	d	L	Inch	BOX	PALLET
		(mm)		(")	(un)	
HL7890011071	110	107-113	72	$\frac{3}{8} * \frac{1}{2}$	40	1600
HL7890012571	125	122-129	80	$\frac{3}{8} * \frac{1}{2}$	30	1200
HL7890016071*	160	157-164	90	$\frac{3}{8} * \frac{1}{2}$	20	800

* Available on demand;

LOCK SEAL™

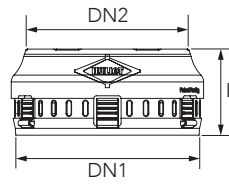

CHARACTERISTICS

COLOUR	Black
RAW MATERIAL	PP-MD
TYPE OF CONNECTION	Push Fit
SERIES	16
STANDARDS	EN 1451-1 ISO 7671 HR 3.43
COMPATIBLE SYSTEMS	ULTRA SILENT

REFERENCE	DN	DN1	DN2	L	BOX	PALLET
	(mm)				(un)	
HL7072330000	75	91,5	79,8	59,0	48	1152
HL7072340000	110	130,0	112,0	63,0	30	480
HL7072350000	125	149,0	126,6	94,0	18	288
HL7072360000*	160	186,5	162,0	99,7	10	240
HL7072380000*	200	233,5	210,0	114,0	5	90

* Available on demand;

END LOCK™

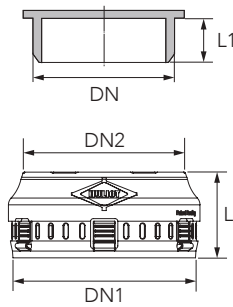

CHARACTERISTICS

COLOUR	Black
RAW MATERIAL	PP-MD
TYPE OF CONNECTION	Push Fit
SERIES	16
STANDARDS	EN 1451-1 ISO 7671 HR 3.43
COMPATIBLE SYSTEMS	ULTRA SILENT

REFERENCE	DN	DN1	DN2	L	L1	BOX	PALLET
	(mm)				(un)		
HL7078004000	110	130,0	112,0	63,0	62	30	480
HL7078005000	125	149,0	126,6	94,0	75	12	192
HL7078006000*	160	186,5	162,0	99,7	86	12	192
HL7078008000*	200	233,5	210,0	114,0	57	4	64

* Available on demand;

PRESSURE CLAMP™

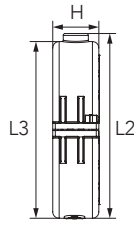
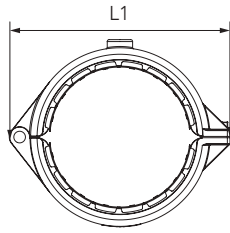

CHARACTERISTICS

COLOUR	Black
RAW MATERIAL	PP-MD
TYPE OF CONNECTION	Push Fit
SERIES	16
STANDARDS	EN 1451-1 ISO 7671 HR 3.43
COMPATIBLE SYSTEMS	ULTRA SILENT

REFERENCE	DN	L1	L2	L3	H	BOX	PALLET
		(mm)				(un)	
HL7073540070	110	170	144,28	138	36	20	800

ULTRA SEAL™

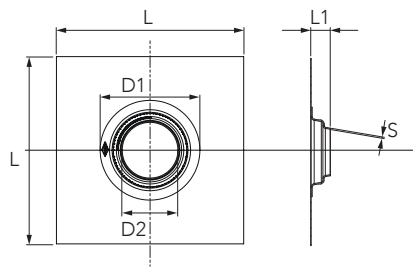

CHARACTERISTICS

COLOUR	Black
RAW MATERIAL	PP-MD
TYPE OF CONNECTION	Push Fit
SERIES	16
STANDARDS	EN 1451-1 ISO 7671 HR 3.43
COMPATIBLE SYSTEMS	ULTRA SILENT

REFERENCE	DIAMETER	DIAMETER 1	DIAMETER 2	L	L1	S	BOX	PALLET
		(mm)				(un)		
HL7981100000	110	220	102	340	52	3	30	480
HL7981250000	125	239	121	500	52	3	20	320
HL7981600000*	160	266	149	500	52	3	20	320

* Available on demand;

BIM

BIM

BIM – Building Information Modelling – It's a revolutionary work methodology of planning, coordinate and follow-up on the multiple phases of the existence of a building.

This methodology contains many advantages regarding material waste reduction and economical and time efficiency. With BIM it's possible to eliminate many construction site errors due to systems incompatibilities given that they were previously taken care of.

To apply BIM you need a tool such as Autodesk Revit®. A multidimensional platform containing one building model with all engineering and architectural components built-in. Therefore, HELIROMA is aiming towards having all main product families in Revit® for maximum productivity of its customers.

To access to our BIM library, please contact our technical department.

How to use our products in Revit®:

1. Open both project and Heliroma files in Revit®;
2. In the project file, got to "Manage";
3. Click "Transfer Project Standards";
4. Transfer "Pipe Systems" from Heliroma file to the project file;
5. Close HELIROMA's file;
6. You're Ready.

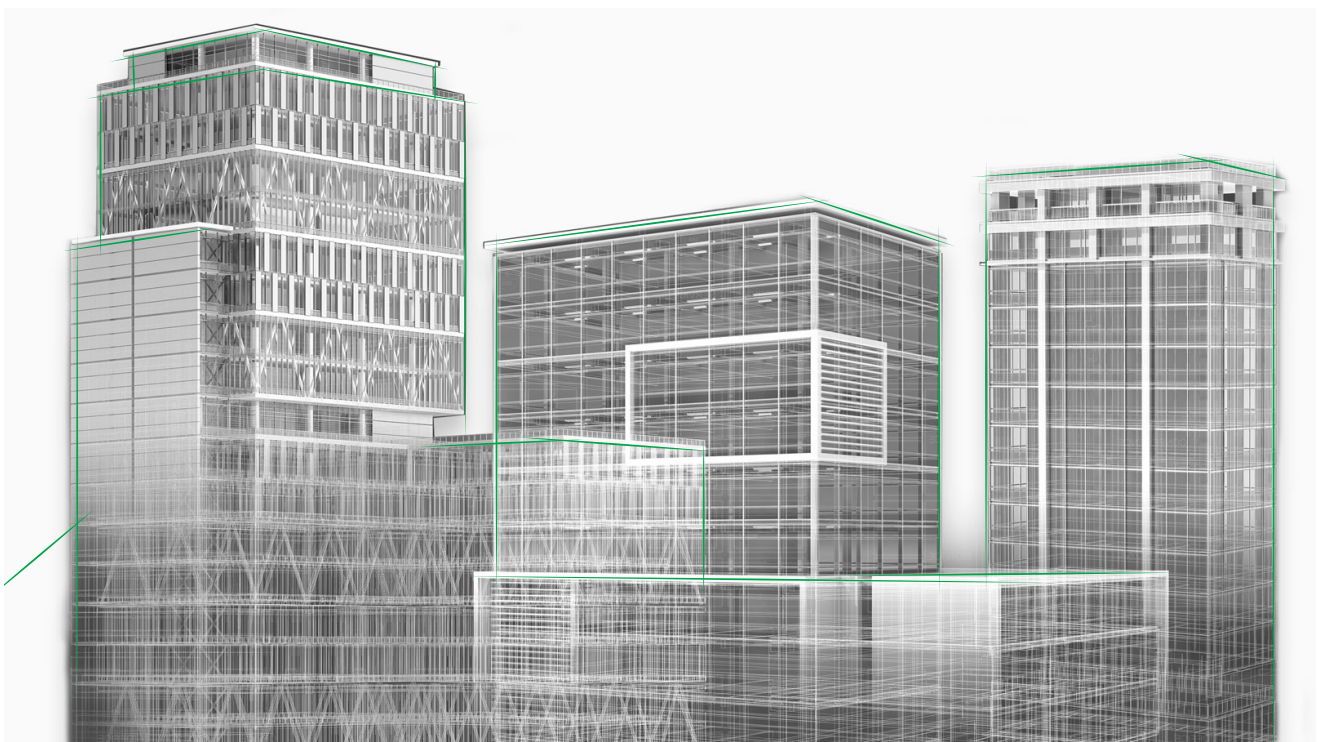





ANNEXES

ANNEX A

- Thermal Expansion

ANNEX B

- Support Intervals

ANNEX C

- Pressure Loss

ANNEX D

- Leakage Test

ANNEX E

- General Sale Conditions

THERMAL EXPANSION

PP-R 100 SDR 6 & SDR 7,4 | HELISYSTEM

Linear expansion coefficient α : 0,15 mm/m K

LENGTH L (m)	Temperature difference - ΔT (°C)							
	10	20	30	40	50	60	70	80
0,10	0,15	0,30	0,45	0,60	0,75	0,90	1,05	1,20
0,15	0,23	0,45	0,68	0,90	1,13	1,35	1,58	1,80
0,20	0,30	0,60	0,90	1,20	1,50	1,80	2,10	2,40
0,25	0,38	0,75	1,13	1,50	1,88	2,25	2,63	3,00
0,30	0,45	0,90	1,35	1,80	2,25	2,70	3,15	3,60
0,35	0,53	1,05	1,58	2,10	2,63	3,15	3,68	4,20
0,40	0,60	1,20	1,80	2,40	3,00	3,60	4,20	4,80
0,45	0,68	1,35	2,03	2,70	3,38	4,05	4,73	5,40
0,50	0,75	1,50	2,25	3,00	3,75	4,50	5,25	6,00
0,55	0,83	1,65	2,48	3,30	4,13	4,95	5,78	6,60
0,60	0,90	1,80	2,70	3,60	4,50	5,40	6,30	7,20
0,65	0,98	1,95	2,93	3,90	4,88	5,85	6,83	7,80
0,70	1,05	2,10	3,15	4,20	5,25	6,30	7,35	8,40
0,75	1,13	2,25	3,38	4,50	5,63	6,75	7,88	9,00
0,80	1,20	2,40	3,60	4,80	6,00	7,20	8,40	9,60
0,85	1,28	2,55	3,83	5,10	6,38	7,65	8,93	10,20
0,90	1,35	2,70	4,05	5,40	6,75	8,10	9,45	10,80
0,95	1,43	2,85	4,28	5,70	7,13	8,55	9,98	11,40
1,00	1,50	3,00	4,50	6,00	7,50	9,00	10,50	12,00
1,50	2,25	4,50	6,75	9,00	11,25	13,50	15,75	18,00
2,00	3,00	6,00	9,00	12,00	15,00	18,00	21,00	24,00
2,50	3,75	7,50	11,25	15,00	18,75	22,50	26,25	30,00
3,00	4,50	9,00	13,50	18,00	22,50	27,00	31,50	36,00
3,50	5,25	10,50	15,75	21,00	26,25	31,50	36,75	42,00
4,00	6,00	12,00	18,00	24,00	30,00	36,00	42,00	48,00
4,50	6,75	13,50	20,25	27,00	33,75	40,50	47,25	54,00
5,00	7,50	15,00	22,50	30,00	37,50	45,00	52,50	60,00
5,50	8,25	16,50	24,75	33,00	41,25	49,50	57,75	66,00
6,00	9,00	18,00	27,00	36,00	45,00	54,00	63,00	72,00
6,50	9,75	19,50	29,25	39,00	48,75	58,50	68,25	78,00
7,00	10,50	21,00	31,50	42,00	52,50	63,00	73,50	84,00
7,50	11,25	22,50	33,75	45,00	56,25	67,50	78,75	90,00
8,00	12,00	24,00	36,00	48,00	60,00	72,00	84,00	96,00
8,50	12,75	25,50	38,25	51,00	63,75	76,50	89,25	102,00
9,00	13,50	27,00	40,50	54,00	67,50	81,00	94,50	108,00
9,50	14,25	28,50	42,75	57,00	71,25	85,50	99,75	114,00
10,00	15,00	30,00	45,00	60,00	75,00	90,00	105,00	120,00

THERMAL EXPANSION

PP-R 100 + FG SDR 7,4 & SDR 11 | ROMAFASER & ROMA KLIMA

Linear expansion coefficient α : 0,035 mm/m K

PP-RCT 125 + FG SDR 11 & SDR 17 | ROMAFASER CT & ROMA KLIMA CT

LENGTH L (m)	Temperature difference - ΔT (°C)							
	10	20	30	40	50	60	70	80
0,10	0,04	0,07	0,11	0,14	0,18	0,21	0,25	0,28
0,15	0,05	0,11	0,16	0,21	0,26	0,32	0,37	0,42
0,20	0,07	0,14	0,21	0,28	0,35	0,42	0,49	0,56
0,25	0,09	0,18	0,26	0,35	0,44	0,53	0,61	0,70
0,30	0,11	0,21	0,32	0,42	0,53	0,63	0,74	0,84
0,35	0,12	0,25	0,37	0,49	0,61	0,74	0,86	0,98
0,40	0,14	0,28	0,42	0,56	0,70	0,84	0,98	1,12
0,45	0,16	0,32	0,47	0,63	0,79	0,95	1,10	1,26
0,50	0,18	0,35	0,53	0,70	0,88	1,05	1,23	1,40
0,55	0,19	0,39	0,58	0,77	0,96	1,16	1,35	1,54
0,60	0,21	0,42	0,63	0,84	1,05	1,26	1,47	1,68
0,65	0,23	0,46	0,68	0,91	1,14	1,37	1,59	1,82
0,70	0,25	0,49	0,74	0,98	1,23	1,47	1,72	1,96
0,75	0,26	0,53	0,79	1,05	1,31	1,58	1,84	2,10
0,80	0,28	0,56	0,84	1,12	1,40	1,68	1,96	2,24
0,85	0,30	0,60	0,89	1,19	1,49	1,79	2,08	2,38
0,90	0,32	0,63	0,95	1,26	1,58	1,89	2,21	2,52
0,95	0,33	0,67	1,00	1,33	1,66	2,00	2,33	2,66
1,00	0,35	0,70	1,05	1,40	1,75	2,10	2,45	2,80
1,50	0,53	1,05	1,58	2,10	2,63	3,15	3,68	4,20
2,00	0,70	1,40	2,10	2,80	3,50	4,20	4,90	5,60
2,50	0,88	1,75	2,63	3,50	4,38	5,25	6,13	7,00
3,00	1,05	2,10	3,15	4,20	5,25	6,30	7,35	8,40
3,50	1,23	2,45	3,68	4,90	6,13	7,35	8,58	9,80
4,00	1,40	2,80	4,20	5,60	7,00	8,40	9,80	11,20
4,50	1,58	3,15	4,73	6,30	7,88	9,45	11,03	12,60
5,00	1,75	3,50	5,25	7,00	8,75	10,50	12,25	14,00
5,50	1,93	3,85	5,78	7,70	9,63	11,55	13,48	15,40
6,00	2,10	4,20	6,30	8,40	10,50	12,60	14,70	16,80
6,50	2,28	4,55	6,83	9,10	11,38	13,65	15,93	18,20
7,00	2,45	4,90	7,35	9,80	12,25	14,70	17,15	19,60
7,50	2,63	5,25	7,88	10,50	13,13	15,75	18,38	21,00
8,00	2,80	5,60	8,40	11,20	14,00	16,80	19,60	22,40
8,50	2,98	5,95	8,93	11,90	14,88	17,85	20,83	23,80
9,00	3,15	6,30	9,45	12,60	15,75	18,90	22,05	25,20
9,50	3,33	6,65	9,98	13,30	16,63	19,95	23,28	26,60
10,00	3,50	7,00	10,50	14,00	17,50	21,00	24,50	28,00

THERMAL EXPANSION

PE-RT / AL / PE-RT | HELIKLIMA

Linear expansion coefficient α : 0,026 mm/m K

LENGTH L (m)	Temperature difference - ΔT (°C)						
	10	20	30	40	50	60	70
1,00	0,26	0,52	0,78	1,04	1,30	1,56	1,82
2,00	0,52	1,04	1,56	2,08	2,60	3,12	3,64
3,00	0,78	1,56	2,34	3,12	3,90	4,68	5,46
4,00	1,04	2,08	3,12	4,16	5,20	6,24	7,28
5,00	1,30	2,60	3,90	5,20	6,50	7,80	9,10
6,00	1,56	3,12	4,68	6,24	7,80	9,36	10,92
7,00	1,82	3,64	5,46	7,28	9,10	10,92	12,74
8,00	2,08	4,16	6,24	8,32	10,40	12,48	14,56
9,00	2,34	4,68	7,02	9,36	11,70	14,04	16,38
10,00	2,60	5,20	7,80	10,40	13,00	15,60	18,20
15,00	3,90	7,80	11,70	15,60	19,50	23,40	27,30
20,00	5,20	10,40	15,60	20,80	26,00	31,20	36,40
25,00	6,50	13,00	19,50	26,00	32,50	39,00	45,50
30,00	7,80	15,60	23,40	31,20	39,00	46,80	54,60
35,00	9,10	18,20	27,30	36,40	45,50	54,60	63,70
40,00	10,40	20,80	31,20	41,60	52,00	62,40	72,80
45,00	11,70	23,40	35,10	46,80	58,50	70,20	81,90
50,00	13,00	26,00	39,00	52,00	65,00	78,00	91,00

THERMAL EXPANSION

PE-Xa | PEXROMA

PE-Xa EVOH | PEXROMA EVOH

Linear expansion coefficient α : 0,14 mm/m K

LENGTH L (m)	Temperature difference - ΔT (°C)							
	10	20	30	40	50	60	70	80
0,10	0,14	0,28	0,42	0,56	0,70	0,84	0,98	1,12
0,20	0,28	0,56	0,84	1,12	1,40	1,68	1,96	2,24
0,30	0,42	0,84	1,26	1,68	2,10	2,52	2,94	3,36
0,40	0,56	1,12	1,68	2,24	2,80	3,36	3,92	4,48
0,50	0,70	1,40	2,10	2,80	3,50	4,20	4,90	5,60
0,60	0,84	1,68	2,52	3,36	4,20	5,04	5,88	6,72
0,70	0,98	1,96	2,94	3,92	4,90	5,88	6,86	7,84
0,80	1,12	2,24	3,36	4,48	5,60	6,72	7,84	8,96
0,90	1,26	2,52	3,78	5,04	6,30	7,56	8,82	10,08
1,00	1,40	2,80	4,20	5,60	7,00	8,40	9,80	11,20
1,50	2,10	4,20	6,30	8,40	10,50	12,60	14,70	16,80
2,00	2,80	5,60	8,40	11,20	14,00	16,80	19,60	22,40
2,50	3,50	7,00	10,50	14,00	17,50	21,00	24,50	28,00
3,00	4,20	8,40	12,60	16,80	21,00	25,20	29,40	33,60
3,50	4,90	9,80	14,70	19,60	24,50	29,40	34,30	39,20
4,00	5,60	11,20	16,80	22,40	28,00	33,60	39,20	44,80
4,50	6,30	12,60	18,90	25,20	31,50	37,80	44,10	50,40
5,00	7,00	14,00	21,00	28,00	35,00	42,00	49,00	56,00
5,50	7,70	15,40	23,10	30,80	38,50	46,20	53,90	61,60
6,00	8,40	16,80	25,20	33,60	42,00	50,40	58,80	67,20
6,50	9,10	18,20	27,30	36,40	45,50	54,60	63,70	72,80
7,00	9,80	19,60	29,40	39,20	49,00	58,80	68,60	78,40
7,50	10,50	21,00	31,50	42,00	52,50	63,00	73,50	84,00
8,00	11,20	22,40	33,60	44,80	56,00	67,20	78,40	89,60
8,50	11,90	23,80	35,70	47,60	59,50	71,40	83,30	95,20
9,00	12,60	25,20	37,80	50,40	63,00	75,60	88,20	100,80
9,50	13,30	26,60	39,90	53,20	66,50	79,80	93,10	106,40
10,00	14,00	28,00	42,00	56,00	70,00	84,00	98,00	112,00
20,00	28,00	56,00	84,00	112,00	140,00	168,00	196,00	224,00
30,00	42,00	84,00	126,00	168,00	210,00	252,00	294,00	336,00
40,00	56,00	112,00	168,00	224,00	280,00	336,00	392,00	448,00
50,00	70,00	140,00	210,00	280,00	350,00	420,00	490,00	560,00

THERMAL EXPANSION

PE-RT | ROMAPLUS

PE-RT EVOH | ROMAPLUS EVOH

Linear expansion coefficient α : 0,18 mm/m K

LENGTH L (m)	Temperature difference - ΔT (°C)							
	10	20	30	40	50	60	70	80
0,10	0,18	0,36	0,54	0,72	0,90	1,08	1,26	1,44
0,20	0,36	0,72	1,08	1,44	1,80	2,16	2,52	2,88
0,30	0,54	1,08	1,62	2,16	2,70	3,24	3,78	4,32
0,40	0,72	1,44	2,16	2,88	3,60	4,32	5,04	5,76
0,50	0,90	1,80	2,70	3,60	4,50	5,40	6,30	7,20
0,60	1,08	2,16	3,24	4,32	5,40	6,48	7,56	8,64
0,70	1,26	2,52	3,78	5,04	6,30	7,56	8,82	10,08
0,80	1,44	2,88	4,32	5,76	7,20	8,64	10,08	11,52
0,90	1,62	3,24	4,86	6,48	8,10	9,72	11,34	12,96
1,00	1,80	3,60	5,40	7,20	9,00	10,80	12,60	14,40
1,50	2,70	5,40	8,10	10,80	13,50	16,20	18,90	21,60
2,00	3,60	7,20	10,80	14,40	18,00	21,60	25,20	28,80
2,50	4,50	9,00	13,50	18,00	22,50	27,00	31,50	36,00
3,00	5,40	10,80	16,20	21,60	27,00	32,40	37,80	43,20
3,50	6,30	12,60	18,90	25,20	31,50	37,80	44,10	50,40
4,00	7,20	14,40	21,60	28,80	36,00	43,20	50,40	57,60
4,50	8,10	16,20	24,30	32,40	40,50	48,60	56,70	64,80
5,00	9,00	18,00	27,00	36,00	45,00	54,00	63,00	72,00
5,50	9,90	19,80	29,70	39,60	49,50	59,40	69,30	79,20
6,00	10,80	21,60	32,40	43,20	54,00	64,80	75,60	86,40
6,50	11,70	23,40	35,10	46,80	58,50	70,20	81,90	93,60
7,00	12,60	25,20	37,80	50,40	63,00	75,60	88,20	100,80
7,50	13,50	27,00	40,50	54,00	67,50	81,00	94,50	108,00
8,00	14,40	28,80	43,20	57,60	72,00	86,40	100,80	115,20
8,50	15,30	30,60	45,90	61,20	76,50	91,80	107,10	122,40
9,00	16,20	32,40	48,60	64,80	81,00	97,20	113,40	129,60
9,50	17,10	34,20	51,30	68,40	85,50	102,60	119,70	136,80
10,00	18,00	36,00	54,00	72,00	90,00	108,00	126,00	144,00
20,00	36,00	72,00	108,00	144,00	180,00	216,00	252,00	288,00
30,00	54,00	108,00	162,00	216,00	270,00	324,00	378,00	432,00
40,00	72,00	144,00	216,00	288,00	360,00	432,00	504,00	576,00
50,00	90,00	180,00	270,00	360,00	450,00	540,00	630,00	720,00

SUPPORT INTERVALS

PP-R 100 SDR 6 & SDR 7,4 | HELISYSTEM

Support intervals recommended according to temperature and outside diameter of the pipe.

DIAMETER (mm)	TEMPERATURE (ΔT)					
	20	30	40	50	60	70
20	65	63	61	60	58	53
25	75	74	70	68	66	61
32	90	88	86	83	80	75
40	110	110	105	100	95	90
50	125	120	115	110	105	100
63	140	135	130	125	120	115
75	155	150	145	135	130	125
90	165	160	155	145	140	130
110	180	175	170	165	150	140

PP-R 100 + FG SDR 7,4 & SDR 11 | ROMAFASER & ROMAKLIMA & RED FIRE

Support intervals recommended according to temperature and outside diameter of the pipe.

DIAMETER (mm)	TEMPERATURE (ΔT)					
	20	30	40	50	60	70
20	85	85	80	80	80	75
25	100	100	95	95	90	85
32	110	115	105	105	105	105
40	130	125	125	125	120	120
50	160	155	150	145	145	135
63	175	170	170	165	160	160
75	185	185	175	170	165	165
90	195	195	190	190	180	175
110	210	210	200	200	195	185

PP-RCT 125 + FG SDR 11 & SDR 17 | ROMAFASER CT & ROMA KLIMA CT

Support intervals recommended according to temperature and outside diameter of the pipe.

DIAMETER (mm)	TEMPERATURE (ΔT)					
	20	30	40	50	60	70
20	85	85	80	80	80	75
25	100	100	95	95	90	85
32	110	115	105	105	105	105
40	130	125	125	125	120	120
50	160	155	150	145	145	135
63	175	170	170	165	160	160
75	185	185	175	170	165	165
90	195	195	190	190	180	175
110	210	210	200	200	195	185
125	235	220	210	205	200	190
160	265	255	245	230	220	215
200	265	240	230	205	195	185
250	270	245	235	210	200	190
315	275	250	240	215	205	195
355	280	255	245	215	210	200
400	295	275	250	225	200	180















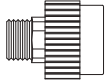

PRESSURE LOSS

PP-R FITTINGS

LOCATED PRESSURE LOSS EQUATION

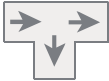
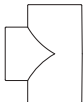
$$Z = \frac{\xi \times v^2 \times \rho}{2}$$

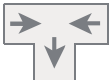
- Z Pressure loss (Pa)
- ξ Coefficient of pressure loss on fittings
- V Flow rate (m/s)
- ρ Density (kg/m³)

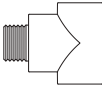
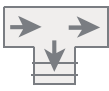
FITTING	Model	Drawing	Coefficient - Pressure Loss
UNION			0,25
REDUCER UNION (UNTIL 2 DIMENTIONS)			0,50
REDUCER UNION (> 2 DIMENTIONS)			0,80
MALE UNION			0,50
REDUCER MALE UNION			0,65
ELBOW 90°			1,80
ELBOW 45°			0,60
MALE ELBOW			2,00
REDUCER MALE ELBOW			3,20
TEE			1,60
TEE			1,10
TEE			3,80
TEE			2,00
REDUCER TEE		The located coefficient of pressure loss results from the sum of the tee and the respective reduction.	
MALE TEE			1,20

PRESSURE LOSS

PP-R 100 SDR 6 | HELISYSTEM

20°C

TEMPERATURE 20°C
 ROUGHNESS 0,007 mm
 DENSITY 998,2 kg/m³
 VISCOSITY 1,004x10⁻⁶ m²/s

FLOW		Temperature difference - ΔT (°C)										
(L/s)	(L/min)	DN	20	25	32	40	50	63	75	90	110	
		THICKNESS	3,4	4,2	5,4	6,7	8,4	10,5	12,5	15,0	18,3	
0,01	0,6	R	0,13	0,04	0,01	0,01						
		V	0,07	0,05	0,03	0,02						
0,02	1,2	R	0,41	0,14	0,04	0,02	0,01					
		V	0,15	0,09	0,06	0,04	0,02					
0,03	1,8	R	0,81	0,28	0,09	0,03	0,01					
		V	0,22	0,14	0,08	0,05	0,03					
0,04	2,4	R	1,32	0,45	0,14	0,05	0,02	0,01				
		V	0,29	0,18	0,11	0,07	0,05	0,03				
0,05	3	R	1,94	0,66	0,21	0,07	0,02	0,01				
		V	0,37	0,23	0,14	0,09	0,06	0,04				
0,06	3,6	R	2,66	0,90	0,28	0,10	0,03	0,01	0,10			
		V	0,44	0,28	0,17	0,11	0,07	0,04	0,03			
0,07	4,2	R	3,47	1,17	0,37	0,13	0,04	0,01	0,01			
		V	0,51	0,32	0,20	0,13	0,08	0,05	0,04			
0,08	4,8	R	4,38	1,47	0,46	0,16	0,05	0,02	0,01			
		V	0,58	0,37	0,23	0,14	0,09	0,06	0,04			
0,09	5,4	R	5,37	1,81	0,57	0,19	0,07	0,02	0,01			
		V	0,66	0,42	0,25	0,16	0,10	0,06	0,05			
0,1	6	R	6,46	2,17	0,68	0,23	0,08	0,03	0,01	0,01		
		V	0,73	0,46	0,28	0,18	0,11	0,07	0,05	0,04		
0,15	9	R	13,21	4,93	1,39	0,47	0,16	0,06	0,03	0,01		
		V	1,10	0,69	0,42	0,27	0,17	0,11	0,08	0,06		
0,2	12	R	22,00	7,31	2,27	0,77	0,26	0,09	0,04	0,02	0,01	
		V	1,46	0,92	0,57	0,36	0,23	0,14	0,10	0,07	0,05	
0,3	18	R	45,52	15,02	4,63	1,57	0,53	0,18	0,08	0,03	0,01	
		V	2,19	1,39	0,85	0,54	0,34	0,22	0,15	0,11	0,07	
0,4	24	R	76,63	25,16	7,73	2,60	0,88	0,29	0,13	0,05	0,02	
		V	2,92	1,85	1,13	0,72	0,46	0,29	0,20	0,14	0,09	
0,5	30	R	115,12	37,63	11,51	3,86	1,30	0,43	0,19	0,08	0,03	
		V	3,65	2,31	1,42	0,90	0,57	0,36	0,25	0,18	0,12	
0,6	36	R	160,87	52,38	15,97	5,34	1,79	0,60	0,26	0,11	0,04	
		V	4,38	2,77	1,70	1,08	0,68	0,43	0,31	0,21	0,14	
0,7	42	R	213,78	69,37	21,09	7,04	2,35	0,79	0,34	0,14	0,05	
		V	5,12	3,23	1,98	1,26	0,80	0,51	0,36	0,25	0,17	
0,8	48	R	273,78	88,57	26,85	8,94	2,99	1,00	0,43	0,18	0,07	
		V	5,85	3,70	2,27	1,44	0,91	0,58	0,41	0,28	0,19	
0,9	54	R		109,97	33,25	11,05	3,69	1,23	0,53	0,22	0,09	
		V		4,16	2,55	1,62	1,03	0,65	0,46	0,32	0,21	
1	60	R		133,53	40,28	13,37	4,45	1,48	0,64	0,27	0,10	
		V		4,62	2,83	1,80	1,14	0,72	0,51	0,35	0,24	

ABBREVIATIONS

- R Pressure loss [mbar/m]
- V Flow Speed [m/s]

TEMPERATURE 20°C
 ROUGHNESS 0,007 mm
 DENSITY 998,2 kg/m³
 VISCOSITY 1,004x10⁻⁶ m²/s

CONTINUED >

FLOW		Temperature difference - ΔT (°C)									
(L/s)	(L/min)	DN	20	25	32	40	50	63	75	90	110
		THICKNESS	3,4	4,2	5,4	6,7	8,4	10,5	12,5	15,0	18,3
1,2	72	R		187,12	56,21	18,60	6,17	2,05	0,89	0,37	0,14
		V		5,54	3,40	2,16	1,37	0,87	0,61	0,42	0,28
1,4	84	R			74,61	24,61	8,15	2,70	1,17	0,49	0,19
		V			3,97	2,52	1,60	1,01	0,71	0,50	0,33
1,6	96	R			95,44	31,40	10,38	3,43	1,48	0,62	0,24
		V			4,53	2,88	1,83	1,15	0,81	0,57	0,38
1,8	108	R			118,68	38,95	12,85	4,24	1,83	0,76	0,29
		V			5,10	3,24	2,05	1,30	0,92	0,64	0,43
2	120	R			144,32	47,26	15,56	5,12	2,21	0,92	0,35
		V			5,67	3,60	2,28	1,44	1,02	0,71	0,47
2,2	132	R				56,32	18,51	6,09	2,62	1,09	0,41
		V				3,96	2,51	1,59	1,12	0,78	0,52
2,4	144	R				66,13	21,70	7,12	3,07	1,27	0,48
		V				4,32	2,74	1,73	1,22	0,85	0,57
2,6	156	R				76,68	25,12	8,24	3,54	1,47	0,56
		V				4,68	2,97	1,88	1,32	0,92	0,61
2,8	168	R				87,97	28,78	9,42	4,05	1,68	0,64
		V				5,04	3,20	2,02	1,43	0,99	0,66
3	180	R				100,00	32,66	10,68	4,59	1,90	0,72
		V				5,40	3,42	2,1,7	1,53	1,06	0,71
3,2	192	R				112,75	36,78	12,02	5,15	2,13	0,81
		V				5,76	3,65	2,31	1,63	1,13	0,76
3,4	204	R					41,13	13,42	5,75	2,38	0,90
		V					3,88	2,45	1,73	1,20	0,80
3,6	216	R					45,71	14,90	6,38	2,64	1,00
		V					4,11	2,60	1,83	1,27	0,85
3,8	228	R					50,51	16,45	7,04	2,91	1,10
		V					4,34	2,74	1,94	1,34	0,90
4	240	R					55,54	18,07	7,73	3,19	1,21
		V					4,57	2,89	2,04	1,41	0,95
4,2	252	R					60,80	19,77	8,45	3,49	1,32
		V					4,79	3,03	2,14	1,49	0,99
4,4	264	R					66,28	21,53	9,20	3,80	1,43
		V					5,02	3,18	2,24	1,56	1,04
4,6	276	R					71,99	23,36	9,98	4,12	1,55
		V					5,25	3,32	2,34	1,63	1,09
4,8	288	R					77,92	25,27	10,78	4,45	1,68
		V					5,48	3,46	2,44	1,70	1,13
5	300	R					84,08	27,24	11,62	4,79	1,81
		V					5,71	3,61	2,55	1,77	1,18

ABBREVIATIONS

R Pressure loss [mbar/m]
 V Flow Speed [m/s]

TEMPERATURE 20°C
 ROUGHNESS 0,007 mm
 DENSITY 998,2 kg/m³
 VISCOSITY 1,004x10⁻⁶ m²/s

CONTINUED >

FLOW		Temperature difference - ΔT (°C)									
(L/s)	(L/min)	DN	20	25	32	40	50	63	75	90	110
		THICKNESS	3,4	4,2	5,4	6,7	8,4	10,5	12,5	15,0	18,3
5,2	312	R						29,28	12,49	5,14	1,94
		V						3,75	2,65	1,84	1,23
5,4	324	R						31,40	13,38	5,51	2,07
		V						3,90	2,75	1,91	1,28
5,6	336	R						33,58	14,30	5,89	2,22
		V						4,04	2,85	1,98	1,32
5,8	348	R						35,83	15,25	6,28	2,36
		V						4,19	2,95	2,05	1,37
6	360	R						38,15	16,23	6,68	2,51
		V						4,33	3,06	2,12	1,42
6,2	372	R						40,54	17,24	7,09	2,66
		V						4,48	3,16	2,19	1,47
6,4	384	R						43,00	18,28	7,51	2,82
		V						4,62	3,26	2,26	1,51
6,6	396	R						45,53	19,35	7,95	2,99
		V						4,76	3,36	2,33	1,56
6,8	408	R						48,12	20,44	8,39	3,15
		V						4,91	3,46	2,41	1,61
7	420	R						50,79	21,56	8,85	3,32
		V						5,05	3,57	2,48	1,65
7,5	450	R						57,75	24,49	10,04	3,77
		V						5,41	3,82	2,65	1,77
8	480	R							27,60	11,31	4,24
		V							4,07	2,83	1,89
9	540	R							34,33	14,04	5,25
		V							4,58	3,18	2,13
10	600	R							41,76	17,05	6,37
		V							5,09	3,54	2,36
12	720	R								23,89	8,90
		V								4,24	2,84
14	840	R								31,82	11,83
		V								4,95	3,31
16	960	R								40,82	15,14
		V								5,66	3,78
18	1080	R									18,84
		V									4,25
20	1200	R									22,91
		V									4,73

ABBREVIATIONS

R Pressure loss [mbar/m]
 V Flow Speed [m/s]

LINEAR PRESSURE LOSS EQUATION

$$\Delta P = R \times L$$

ΔP Linear pressure loss (Pa)
 R Pipe friction pressure gradient (Pa/m)
 L Pipe length (m)

PRESSURE LOSS

PP-R 100 SDR 6 | HELISYSTEM

60°C

TEMPERATURE 60°C
 ROUGHNESS 0,007 mm
 DENSITY 983,2 kg/m³
 VISCOSITY 4,74x10⁻⁷ m²/s

FLOW		Temperature difference - ΔT (°C)									
(L/s)	(L/min)	DN	20	25	32	40	50	63	75	90	110
		THICKNESS	3,4	4,2	5,4	6,7	8,4	10,5	12,5	15,0	18,3
0,01	0,6	R	0,10	0,03	0,01						
		V	0,07	0,05	0,03						
0,02	1,2	R	0,32	0,11	0,03	0,01					
		V	0,15	0,09	0,06	0,04					
0,03	1,8	R	0,64	0,22	0,07	0,02	0,01				
		V	0,22	0,14	0,08	0,05	0,03				
0,04	2,4	R	1,06	0,36	0,11	0,04	0,01				
		V	0,29	0,18	0,11	0,07	0,05				
0,05	3	R	1,57	0,53	0,16	0,06	0,02	0,01			
		V	0,37	0,23	0,14	0,09	0,06	0,04			
0,06	3,6	R	2,16	0,72	0,23	0,08	0,03	0,01			
		V	0,44	0,28	0,17	0,11	0,07	0,04			
0,07	4,2	R	2,84	0,95	0,30	0,10	0,03	0,01	0,01		
		V	0,51	0,32	0,20	0,13	0,08	0,05	0,04		
0,08	4,8	R	3,60	1,20	0,37	0,13	0,04	0,01	0,01		
		V	0,58	0,37	0,23	0,14	0,09	0,06	0,04		
0,09	5,4	R	4,43	1,47	0,46	0,16	0,05	0,02	0,01		
		V	0,66	0,42	0,25	0,16	0,10	0,06	0,05		
0,1	6	R	5,35	1,78	0,55	0,19	0,06	0,02	0,01		
		V	0,73	0,46	0,28	0,18	0,11	0,07	0,05		
0,15	9	R	11,42	3,76	1,16	0,39	0,14	0,05	0,02	0,01	
		V	1,10	0,69	0,48	0,27	0,18	0,11	0,08	0,05	
0,2	12	R	18,68	6,12	1,88	0,63	0,21	0,07	0,03	0,01	0,01
		V	1,46	0,92	0,57	0,36	0,23	0,14	0,10	0,07	0,05
0,3	18	R	39,26	12,77	3,89	1,30	0,44	0,15	0,06	0,03	0,01
		V	2,19	1,39	0,85	0,54	0,34	0,22	0,15	0,11	0,07
0,4	24	R	66,87	21,61	6,54	2,18	0,73	0,24	0,11	0,04	0,02
		V	2,92	1,85	1,13	0,72	0,46	0,29	0,20	0,14	0,09
0,5	30	R	101,42	32,59	9,82	3,26	1,08	0,36	0,16	0,07	0,02
		V	3,65	2,31	1,42	0,90	0,57	0,36	0,25	0,18	0,12
0,6	36	R	142,83	45,70	13,71	4,53	1,50	0,50	0,22	0,09	0,03
		V	4,38	2,77	1,70	1,08	0,68	0,43	0,31	0,21	0,14
0,7	42	R	191,08	60,91	18,21	6,00	1,99	0,66	0,28	0,12	0,05
		V	5,12	3,23	1,98	1,26	0,80	0,51	0,36	0,25	0,17
0,8	48	R	246,13	78,20	23,30	7,66	2,53	0,83	0,36	0,15	0,06
		V	5,85	3,70	2,27	1,44	0,91	0,58	0,41	0,28	0,19
0,9	54	R		97,57	28,98	9,50	3,13	1,03	0,44	0,19	0,07
		V		4,16	2,55	1,62	1,03	0,65	0,46	0,32	0,21
1	60	R		119,00	35,25	11,53	3,79	1,25	0,54	0,22	0,08
		V		4,62	2,83	1,80	1,14	0,72	0,51	0,35	0,24

ABBREVIATIONS

- R Pressure loss [mbar/m]
- V Flow Speed [m/s]

TEMPERATURE 60°C
 ROUGHNESS 0,007 mm
 DENSITY 983,2 kg/m³
 VISCOSITY 4,74x10⁻⁷ m²/s

CONTINUED >

FLOW		Temperature difference - ΔT (°C)									
(L/s)	(L/min)	DN	20	25	32	40	50	63	75	90	110
		THICKNESS	3,4	4,2	5,4	6,7	8,4	10,5	12,5	15,0	18,3
1,2	72	R		168,05	49,55	16,14	5,29	1,74	0,75	0,31	0,12
		V		5,54	3,40	2,16	1,37	0,87	0,61	0,42	0,28
1,4	84	R			66,18	21,48	7,02	2,30	0,99	0,41	0,15
		V			3,97	2,52	1,60	1,01	0,71	0,50	0,33
1,6	96	R			85,11	27,55	8,98	2,93	1,26	0,52	0,20
		V			4,53	2,88	1,83	1,15	0,81	0,57	0,38
1,8	108	R			106,35	34,33	11,16	3,63	1,56	0,64	0,24
		V			5,10	3,24	2,05	1,30	0,92	0,64	0,43
2	120	R			129,89	41,82	13,56	4,41	1,88	0,78	0,29
		V			5,67	3,60	2,28	1,44	1,02	0,71	0,47
2,2	132	R				50,03	16,19	5,25	2,24	0,93	0,35
		V				3,96	2,51	1,59	1,12	0,78	0,52
2,4	144	R				58,95	19,04	6,17	2,63	1,08	0,41
		V				4,32	2,74	1,73	1,22	0,85	0,57
2,6	156	R				68,57	22,11	7,15	3,05	1,25	0,47
		V				4,68	2,97	1,88	1,32	0,92	0,61
2,8	168	R				78,90	25,39	8,20	3,49	1,43	0,54
		V				5,04	3,20	2,02	1,43	0,99	0,66
3	180	R				89,93	28,90	9,32	3,96	1,63	0,61
		V				5,40	3,42	2,17	1,53	1,06	0,71
3,2	192	R				101,66	32,62	10,50	4,46	1,83	0,69
		V				5,76	3,65	2,31	1,63	1,13	0,76
3,4	204	R					36,56	11,76	4,99	2,05	0,77
		V					3,88	2,45	1,73	1,20	0,80
3,6	216	R					40,72	13,08	5,54	2,27	0,85
		V					4,11	2,60	1,83	1,27	0,85
3,8	228	R					45,10	14,46	6,13	2,51	0,94
		V					4,34	2,74	1,94	1,34	0,90
4	240	R					49,69	15,92	6,74	2,76	1,03
		V					4,57	2,89	2,04	1,41	0,95
4,2	252	R					54,49	17,44	7,38	3,02	1,13
		V					4,79	3,03	2,14	1,49	0,99
4,4	264	R					59,51	19,03	8,04	3,29	1,23
		V					5,02	3,18	2,24	1,56	1,04
4,6	276	R					64,75	20,68	8,74	3,57	1,33
		V					5,25	3,32	2,34	1,63	1,09
4,8	288	R					70,20	22,40	9,46	3,86	1,44
		V					5,48	3,46	2,44	1,70	1,13
5	300	R					75,87	24,19	10,20	4,16	1,55
		V					5,71	3,61	2,55	1,77	1,18

ABBREVIATIONS

R Pressure loss [mbar/m]
 V Flow Speed [m/s]

TEMPERATURE 60°C
 ROUGHNESS 0,007 mm
 DENSITY 983,2 kg/m³
 VISCOSITY 4,74x10⁻⁷ m²/s

CONTINUED >

FLOW		Temperature difference - ΔT (°C)									
(L/s)	(L/min)	DN	20	25	32	40	50	63	75	90	110
		THICKNESS	3,4	4,2	5,4	6,7	8,4	10,5	12,5	15,0	18,3
5,2	312	R						26,04	10,98	4,48	1,67
		V						3,75	2,65	1,84	1,23
5,4	324	R						27,96	11,78	4,80	1,79
		V						3,90	2,75	1,91	1,28
5,6	336	R						29,94	12,61	5,13	1,91
		V						4,04	2,85	1,98	1,32
5,8	348	R						31,99	13,46	5,48	2,04
		V						4,19	2,95	2,05	1,37
6	360	R						34,11	14,35	5,84	2,17
		V						4,33	3,06	2,12	1,42
6,2	372	R						36,29	15,26	6,20	2,31
		V						4,48	3,16	2,19	1,47
6,4	384	R						38,53	16,19	6,58	2,45
		V						4,62	3,26	2,26	1,51
6,6	396	R						40,85	17,15	6,97	2,59
		V						4,76	3,36	2,33	1,56
6,8	408	R						43,22	18,14	7,37	2,74
		V						4,91	3,46	2,41	1,61
7	420	R						45,67	19,16	7,77	2,89
		V						5,05	3,57	2,48	1,65
7,5	450	R						52,06	21,82	8,84	3,28
		V						5,41	3,82	2,65	1,77
8	480	R						58,86	24,64	9,98	3,70
		V						5,77	4,07	2,83	1,89
9	540	R							30,79	12,44	4,60
		V							4,58	3,18	2,13
10	600	R							37,60	15,16	5,60
		V							5,09	3,54	2,36
12	720	R								21,39	7,87
		V								4,24	2,84
14	840	R								28,64	10,51
		V								4,95	3,31
16	960	R								36,92	13,51
		V								5,66	3,78
18	1080	R									16,88
		V									4,25
20	1200	R									20,61
		V									4,73

ABBREVIATIONS

R Pressure loss [mbar/m]
 V Flow Speed [m/s]

LINEAR PRESSURE LOSS EQUATION

$\Delta P = R \times L$

ΔP Linear pressure loss (Pa)
 R Pipe friction pressure gradient (Pa/m)
 L Pipe length (m)

PRESSURE LOSS

PP-R 100 SDR 7,4 | HELISYSTEM
 PP-R 100 + FG SDR 7,4 | ROMAFASER
 20°C

TEMPERATURE 20°C
 ROUGHNESS 0,007 mm
 DENSITY 998,2 kg/m³
 VISCOSITY 1,004x10⁻⁶ m²/s

FLOW		Temperature difference - ΔT (°C)														
(L/s)	(L/min)	DN	20	25	32	40	50	63	75	90	110	125	160	200	250	
		THICKNESS	2,8	3,5	4,4	5,5	6,9	8,6	10,3	12,3	15,1	17,1	21,9	27,4	34,2	
0,01	0,6	R	0,00													
		V	0,01													
0,02	1,2	R	0,30													
		V	0,10													
0,03	1,8	R	0,50	0,20												
		V	0,20	0,10												
0,04	2,4	R	0,90	0,30												
		V	0,20	0,20												
0,05	3	R	1,31	0,40	0,10											
		V	0,30	0,20	0,10											
0,06	3,6	R	1,71	0,60	0,20											
		V	0,40	0,20	0,10											
0,07	4,2	R	2,31	0,80	0,20	0,10										
		V	0,40	0,30	0,20	0,10										
0,08	4,8	R	2,91	1,01	0,30	0,10										
		V	0,50	0,30	0,20	0,10										
0,09	5,4	R	3,52	1,21	0,40	0,10										
		V	0,60	0,40	0,20	0,10										
0,1	6	R	4,22	1,51	0,40	0,20										
		V	0,60	0,40	0,20	0,20										
0,15	9	R	8,77	2,99	0,90	0,30	0,10	0,00								
		V	0,93	0,60	0,40	0,20	0,10	0,10								
0,2	12	R	14,47	4,92	1,51	0,50	0,20	0,10								
		V	1,21	0,80	0,50	0,30	0,20	0,10								
0,3	18	R	29,95	10,15	3,02	1,01	0,40	0,10	0,10							
		V	1,81	1,21	0,70	0,50	0,30	0,20	0,10							
0,4	24	R	50,35	17,09	5,03	1,71	0,60	0,20	0,10							
		V	2,51	1,61	0,90	0,60	0,40	0,20	0,20	0,10						
0,5	30	R	75,48	25,43	7,44	2,51	0,90	0,30	0,10	0,10						
		V	3,12	2,01	1,21	0,80	0,50	0,30	0,20	0,10						
0,6	36	R	105,32	35,48	10,35	3,52	1,21	0,40	0,20	0,10						
		V	3,72	2,41	1,41	0,90	0,60	0,40	0,30	0,20	0,10					
0,7	42	R	139,90	46,93	13,67	4,62	1,61	0,50	0,20	0,10	0,00					
		V	4,32	2,81	1,71	1,11	0,70	0,40	0,30	0,20	0,10	0,10				
0,8	48	R	178,99	59,80	17,39	5,93	2,01	0,70	0,30	0,10	0,00	0,00				
		V	4,92	3,12	1,91	1,21	0,80	0,50	0,30	0,20	0,20	0,10				
0,9	54	R	222,61	74,27	21,51	7,34	2,51	0,80	0,40	0,10	0,10	0,00				
		V	5,53	3,52	2,11	1,41	0,90	0,50	0,40	0,30	0,20	0,10				
1	60	R	270,75	90,15	26,03	8,84	3,02	1,01	0,40	0,20	0,10	0,00				
		V	6,13	3,92	2,41	1,51	1,01	0,60	0,40	0,30	0,20	0,20				

ABBREVIATIONS

R Pressure loss [mbar/m]
 V Flow Speed [m/s]

TEMPERATURE 20°C
 ROUGHNESS 0,007 mm
 DENSITY 998,2 kg/m³
 VISCOSITY 1,004x10⁻⁶ m²/s

CONTINUED >

FLOW		Temperature difference - ΔT (°C)														
(L/s)	(L/min)	DN	20	25	32	40	50	63	75	90	110	125	160	200	250	
		THICKNESS	2,8	3,5	4,4	5,5	6,9	8,6	10,3	12,3	15,1	17,1	21,9	27,4	34,2	
1,2	72	R	380,49	126,13	36,38	12,26	4,22	1,31	0,60	0,20	0,10	0,10				
		V	7,44	4,72	2,81	1,81	1,21	0,70	0,50	0,40	0,20	0,20				
1,4	84	R	508,03	167,84	48,24	16,28	5,53	1,81	0,80	0,30	0,10	0,10	0,00			
		V	8,64	5,53	3,32	2,11	1,41	0,80	0,60	0,40	0,30	0,20	0,10			
1,6	96	R	653,35	215,17	61,61	20,70	7,04	2,31	1,01	0,40	0,20	0,10	0,00			
		V	9,85	6,33	3,82	2,41	1,61	1,01	0,70	0,50	0,30	0,20	0,20			
1,8	108	R		268,03	76,20	25,50	8,70	2,80	1,20	0,50	0,20	0,10	0,00			
		V		7,14	4,32	2,71	1,71	1,11	0,80	0,50	0,40	0,30	0,20			
2	120	R		326,63	92,96	31,16	10,55	3,42	1,51	0,60	0,20	0,10	0,00			
		V		7,94	4,72	3,02	1,91	1,21	0,90	0,60	0,40	0,30	0,20			
2,2	132	R		390,64	110,95	37,08	12,56	4,02	1,71	0,70	0,30	0,10	0,00			
		V		8,64	5,23	3,32	2,11	1,31	0,90	0,70	0,40	0,30	0,20			
2,4	144	R		460,19	130,45	43,52	14,77	4,72	2,01	0,80	0,30	0,20	0,10	0,00		
		V		9,45	5,73	3,62	2,31	1,51	1,01	0,70	0,50	0,40	0,20	0,10		
2,6	156	R		535,26	151,45	50,45	17,09	5,43	2,41	1,01	0,40	0,20	0,10	0,00		
		V		10,25	6,23	3,92	2,51	1,61	1,11	0,80	0,50	0,40	0,20	0,10		
2,8	168	R			173,87	57,79	19,50	6,23	2,71	1,11	0,40	0,20	0,10	0,00		
		V			6,63	4,22	2,71	1,71	1,21	0,80	0,60	0,40	0,30	0,10		
3	180	R			197,88	65,73	22,11	7,04	3,12	1,31	0,50	0,30	0,10	0,00		
		V			7,14	4,52	2,91	1,81	1,31	0,90	0,60	0,50	0,30	0,20		
3,2	192	R			223,31	74,07	24,92	7,94	3,42	1,41	0,50	0,30	0,10	0,00	0,00	
		V			7,64	4,82	3,12	1,91	1,41	1,01	0,60	0,50	0,30	0,20	0,10	
3,4	204	R			250,25	82,81	27,84	8,84	3,82	1,61	0,60	0,30	0,10	0,00	0,00	
		V			8,04	5,13	3,32	2,11	1,51	1,01	0,70	0,50	0,30	0,20	0,10	
3,6	216	R			278,59	92,16	30,95	9,85	4,22	1,71	0,70	0,40	0,10	0,00	0,00	
		V			8,54	5,53	3,52	2,21	1,51	1,11	0,70	0,60	0,30	0,20	0,10	
3,8	228	R			308,43	101,91	34,17	10,85	4,72	1,91	0,70	0,40	0,10	0,00	0,00	
		V			9,05	5,83	3,72	2,31	1,61	1,11	0,80	0,60	0,40	0,20	0,10	
4	240	R			339,79	112,16	37,59	11,96	5,13	2,11	0,80	0,40	0,10	0,00	0,00	
		V			9,55	6,13	3,92	2,41	1,71	1,21	0,80	0,60	0,40	0,20	0,10	
4,2	252	R			372,65	122,81	41,21	13,07	5,63	2,31	0,90	0,50	0,10	0,00	0,00	
		V			9,95	6,43	4,12	2,51	1,81	1,31	0,80	0,60	0,40	0,20	0,10	
4,4	264	R				133,97	44,82	14,17	6,13	2,51	1,01	0,50	0,20	0,00	0,00	
		V				6,73	4,32	2,71	1,91	1,31	0,90	0,70	0,40	0,20	0,10	
4,6	276	R				145,62	48,74	15,38	6,63	2,71	1,01	0,60	0,20	0,00	0,00	
		V				7,04	4,52	2,81	2,01	1,41	0,90	0,70	0,40	0,30	0,20	
4,8	288	R				157,68	52,66	16,68	7,24	2,91	1,11	0,60	0,20	0,10	0,00	
		V				7,34	4,72	2,91	2,11	1,41	1,01	0,70	0,50	0,30	0,20	
5	300	R				170,25	56,88	17,89	7,74	3,22	1,21	0,60	0,20	0,10	0,00	
		V				7,64	4,92	3,02	2,21	1,51	1,01	0,80	0,50	0,30	0,20	

ABBREVIATIONS

R Pressure loss [mbar/m]
 V Flow Speed [m/s]

TEMPERATURE 20°C
ROUGHNESS 0,007 mm
DENSITY 998,2 kg/m³
VISCOSITY 1,004x10⁻⁶ m²/s

CONTINUED >

FLOW		Temperature difference - ΔT (°C)													
(L/s)	(L/min)	DN	20	25	32	40	50	63	75	90	110	125	160	200	250
		THICKNESS	2,8	3,5	4,4	5,5	6,9	8,6	10,3	12,3	15,1	17,1	21,9	27,4	34,2
5,2	312	R				183,21	61,10	19,30	8,34	3,42	1,31	0,70	0,20	0,10	
		V				7,94	5,13	3,22	2,21	1,51	1,01	0,80	0,50	0,30	
5,4	324	R				196,78	65,63	20,70	8,94	3,62	1,41	0,70	0,20	0,10	0,00
		V				8,24	5,23	3,32	2,31	1,61	1,11	0,80	0,50	0,30	0,20
5,6	336	R				210,65	70,15	22,11	9,55	3,92	1,51	0,80	0,20	0,10	0,00
		V				8,54	5,43	3,42	2,41	1,71	1,11	0,90	0,50	0,30	0,20
5,8	348	R				225,12	74,97	23,62	10,15	4,12	1,61	0,80	0,30	0,10	0,00
		V				8,84	5,63	3,52	2,51	1,71	1,21	0,90	0,50	0,30	0,20
6	360	R				239,89	79,80	25,13	10,85	4,42	1,71	0,90	0,30	0,10	0,00
		V				9,15	5,83	3,62	2,61	1,81	1,21	0,90	0,60	0,30	0,20
6,2	372	R				255,27	84,82	26,63	11,46	4,72	1,81	1,01	0,30	0,10	0,00
		V				9,45	6,03	3,82	2,71	1,81	1,21	1,01	0,60	0,40	0,20
6,4	384	R				271,05	90,05	28,24	12,16	4,92	1,91	1,01	0,30	0,10	0,00
		V				9,75	6,23	3,92	2,81	1,91	1,31	1,01	0,60	0,40	0,20
6,6	396	R				287,33	95,37	29,95	12,86	5,23	2,01	1,11	0,30	0,10	0,00
		V				10,05	6,43	4,02	2,81	2,01	1,31	1,01	0,60	0,40	0,20
6,8	408	R				303,90	100,90	31,66	13,57	5,53	2,11	1,11	0,30	0,10	0,00
		V				10,35	6,63	4,12	2,91	2,01	1,41	1,11	0,60	0,40	0,20
7	420	R				321,53	106,53	33,37	14,37	5,83	2,21	1,21	0,40	0,10	0,00
		V				10,70	6,83	4,22	3,02	2,11	1,41	1,11	0,70	0,40	0,30
7,5	450	R				351,20	121,20	37,89	16,28	6,63	2,51	1,31	0,40	0,10	0,00
		V				11,40	7,34	4,62	3,22	2,21	1,51	1,21	0,70	0,40	0,30
8	480	R				386,78	136,78	42,71	18,39	7,44	2,81	1,51	0,50	0,10	0,00
		V				12,10	7,84	4,92	3,42	2,41	1,61	1,21	0,80	0,40	0,30
9	540	R				427,75	170,75	53,27	22,81	9,25	3,52	1,91	0,60	0,10	0,00
		V				13,10	8,74	5,53	3,92	2,71	1,81	1,41	0,80	0,50	0,30
10	600	R				474,34	208,34	64,82	27,74	11,26	4,22	2,31	0,70	0,20	0,00
		V				14,10	9,75	6,13	4,32	3,02	2,01	1,51	0,90	0,50	0,30
12	720	R				526,47	294,47	91,15	38,89	15,78	5,93	3,22	1,01	0,20	0,10
		V				15,10	11,76	7,34	5,23	3,62	2,41	1,91	1,11	0,50	0,30
14	840	R				584,91	412,91	121,91	51,96	21,00	7,94	4,22	1,31	0,20	0,10
		V				16,10	8,54	6,03	4,22	2,81	2,21	1,31	0,60	0,30	
16	960	R				649,88	566,88	156,88	66,73	26,83	10,15	5,43	1,61	0,30	0,10
		V				17,10	9,75	6,93	4,82	3,22	2,51	1,51	0,70	0,40	
18	1080	R				721,08	737,08	196,08	83,21	33,47	12,56	6,73	2,01	0,40	0,10
		V				18,10	10,95	7,74	5,43	3,62	2,81	1,71	0,80	0,50	
20	1200	R				806,51	916,51	261,51	101,51	40,70	15,28	8,14	2,41	0,50	0,10
		V				19,10	8,64	6,03	4,02	3,12	1,91	1,01	0,50	0,30	
22	1320	R				904,50	1044,50	304,50	121,50	48,74	18,29	9,65	2,91	0,70	0,20
		V				20,10	9,55	6,53	4,42	3,42	2,11	1,11	0,60	0,40	

ABBREVIATIONS

R Pressure loss [mbar/m]
V Flow Speed [m/s]

TEMPERATURE 20°C
 ROUGHNESS 0,007 mm
 DENSITY 998,2 kg/m³
 VISCOSITY 1,004x10⁻⁶ m²/s

CONTINUED >

FLOW		Temperature difference - ΔT (°C)													
(L/s)	(L/min)	DN	20	25	32	40	50	63	75	90	110	125	160	200	250
		THICKNESS	2,8	3,5	4,4	5,5	6,9	8,6	10,3	12,3	15,1	17,1	21,9	27,4	34,2
24	1440	R							143,31	57,39	21,51	11,36	3,42	0,80	0,20
		V							10,35	7,14	4,82	3,72	2,31	1,21	0,70
26	1560	R								66,63	24,92	13,17	3,92	1,01	0,30
		V								7,74	5,23	4,02	2,51	1,31	0,80
28	1680	R								76,68	28,64	15,18	4,52	1,11	0,30
		V								8,34	5,63	4,32	2,61	1,41	0,80
30	1800	R								87,33	32,56	17,19	5,13	1,31	0,40
		V								8,94	6,03	4,62	2,81	1,61	0,90
32	1920	R								98,69	36,78	19,40	5,83	1,51	0,50
		V								9,55	6,43	4,92	3,02	1,71	1,01
34	2040	R								110,65	41,21	21,71	6,43	1,71	0,50
		V								10,15	6,83	5,33	3,22	1,81	1,11
36	2160	R									45,83	24,22	7,24	1,91	0,60
		V									7,24	5,63	3,42	1,91	1,21
38	2280	R									50,75	26,83	7,94	2,21	0,70
		V									7,64	5,93	3,62	2,11	1,21
40	2400	R									55,88	29,45	8,74	2,41	0,70
		V									8,04	6,23	3,82	2,21	1,31
42	2520	R									61,31	32,36	9,55	2,71	0,80
		V									8,44	6,53	4,02	2,31	1,41
44	2640	R									66,93	35,28	10,45	2,91	0,90
		V									8,84	6,83	4,12	2,41	1,51
46	2760	R									72,76	38,29	11,36	3,22	1,01
		V									9,25	7,14	4,32	2,51	1,51
48	2880	R									78,89	41,51	12,26	3,52	1,11
		V									9,65	7,44	4,52	2,71	1,61
50	3000	R									85,22	44,82	13,27	3,82	1,21
		V									10,05	7,74	4,72	2,81	1,71
60	3600	R										63,32	18,69	6,23	2,11
		V										9,35	5,73	3,62	2,31
70	4200	R										84,82	24,92	8,34	2,81
		V										10,85	6,63	4,22	2,71
80	4800	R											32,06	10,65	3,52
		V											7,54	4,82	3,12
90	5400	R											40,00	13,27	4,42
		V											8,54	5,43	3,52
100	6000	R											48,84	16,18	5,43
		V											9,45	6,03	3,92
150	9000	R												34,77	11,46
		V												9,15	5,83

ABBREVIATIONS

R Pressure loss [mbar/m]
 V Flow Speed [m/s]

LINEAR PRESSURE LOSS EQUATION

$\Delta P = R \times L$
 ΔP Linear pressure loss (Pa)
 R Pipe friction pressure gradient (Pa/m)
 L Pipe length (m)

PRESSURE LOSS

PP-R 100 SDR 7,4 | HELISYSTEM
 PP-R 100 + FG SDR 7,4 | ROMAFASER
 60°C

TEMPERATURE 60°C
 ROUGHNESS 0,007 mm
 DENSITY 983,2 kg/m³
 VISCOSITY 4,74x10⁻⁷ m²/s

FLOW		Temperature difference - ΔT (°C)													
(L/s)	(L/min)	DN	20	25	32	40	50	63	75	90	110	125	160	200	250
		THICKNESS	2,8	3,5	4,4	5,5	6,9	8,6	10,3	12,3	15,1	17,1	21,9	27,4	34,2
0,01	0,6	R	0,00												
		V	0,01												
0,02	1,2	R	0,20												
		V	0,10												
0,03	1,8	R	0,40	0,10											
		V	0,20	0,10											
0,04	2,4	R	0,70	0,20											
		V	0,20	0,20											
0,05	3	R	1,00	0,40	0,10										
		V	0,30	0,20	0,10										
0,06	3,6	R	1,40	0,50	0,10										
		V	0,40	0,20	0,10										
0,07	4,2	R	1,91	0,60	0,20	0,10									
		V	0,40	0,30	0,20	0,10									
0,08	4,8	R	2,41	0,80	0,20	0,10									
		V	0,50	0,30	0,20	0,10									
0,09	5,4	R	2,91	1,00	0,30	0,10									
		V	0,60	0,40	0,20	0,10									
0,1	6	R	3,51	1,20	0,40	0,10									
		V	0,60	0,40	0,20	0,20	0,00								
0,15	9	R	7,32	2,53	0,73	0,30	0,10								
		V	0,93	0,60	0,40	0,20	0,10								
0,2	12	R	12,24	4,11	1,20	0,40	0,10								
		V	1,20	0,80	0,50	0,30	0,20	0,10							
0,3	18	R	25,68	8,63	2,51	0,90	0,30	0,10							
		V	1,81	1,20	0,70	0,50	0,30	0,20	0,10						
0,4	24	R	43,63	14,54	4,21	1,40	0,50	0,20	0,10						
		V	2,51	1,60	0,90	0,60	0,40	0,20	0,20	0,10					
0,5	30	R	66,00	21,97	6,32	2,11	0,70	0,20	0,10	0,00					
		V	3,11	2,01	1,20	0,80	0,50	0,30	0,20	0,10					
0,6	36	R	92,78	30,69	8,83	3,01	1,00	0,30	0,10	0,10					
		V	3,71	2,41	1,40	0,90	0,60	0,40	0,30	0,20	0,10				
0,7	42	R	123,97	40,92	11,74	3,91	1,30	0,40	0,20	0,10	0,00				
		V	4,31	2,81	1,71	1,10	0,70	0,40	0,30	0,20	0,10	0,10			
0,8	48	R	159,58	52,46	15,05	5,02	1,71	0,50	0,20	0,10	0,00	0,00			
		V	4,91	3,11	1,91	1,20	0,80	0,50	0,30	0,20	0,20	0,10			
0,9	54	R	199,40	65,40	18,66	6,22	2,11	0,70	0,30	0,10	0,00	0,00			
		V	5,52	3,51	2,11	1,40	0,90	0,50	0,40	0,30	0,20	0,10			
1	60	R	243,63	79,74	22,67	7,62	2,61	0,80	0,40	0,10	0,10	0,00			
		V	6,12	3,91	2,41	1,50	1,00	0,60	0,40	0,30	0,20	0,20			

ABBREVIATIONS

R Pressure loss [mbar/m]
 V Flow Speed [m/s]

TEMPERATURE 60°C
ROUGHNESS 0,007 mm
DENSITY 983,2 kg/m³
VISCOSITY 4,74x10⁻⁷ m²/s

CONTINUED >

FLOW		Temperature difference - ΔT (°C)															
(L/s)	(L/min)	DN	20	25	32	40	50	63	75	90	110	125	160	200	250		
		THICKNESS	2,8	3,5	4,4	5,5	6,9	8,6	10,3	12,3	15,1	17,1	21,9	27,4	34,2		
1,2	72	R	344,93	112,34	31,80	10,63	3,61	1,10	0,50	0,20	0,10	0,00	0,00				
		V	7,42	4,71	2,81	1,81	1,20	0,70	0,50	0,40	0,20	0,20	0,10				
1,4	84	R	463,49	150,45	42,43	14,04	4,71	1,50	0,70	0,30	0,10	0,10	0,00				
		V	8,63	5,52	3,31	2,11	1,40	0,80	0,60	0,40	0,30	0,20	0,10				
1,6	96	R	599,29	193,98	54,46	18,05	6,12	1,91	0,80	0,30	0,10	0,10	0,00				
		V	9,83	6,32	3,81	2,41	1,60	1,00	0,70	0,50	0,30	0,20	0,20				
1,8	108	R	752,25	242,83	68,00	22,47	7,52	2,41	1,00	0,40	0,20	0,10	0,00				
		V	11,13	7,12	4,31	2,71	1,71	1,10	0,80	0,50	0,40	0,30	0,20				
2	120	R			82,95	27,38	9,13	2,91	1,30	0,50	0,20	0,10	0,00				
		V			4,71	3,01	1,91	1,20	0,90	0,60	0,40	0,30	0,20	0,10			
2,2	132	R			99,40	32,70	10,93	3,41	1,50	0,60	0,20	0,10	0,00	0,00			
		V			5,22	3,31	2,11	1,30	0,90	0,70	0,40	0,30	0,20	0,10			
2,4	144	R			117,25	38,52	12,84	4,01	1,71	0,70	0,30	0,10	0,00	0,00			
		V			5,72	3,61	2,31	1,50	1,00	0,70	0,50	0,40	0,20	0,10			
2,6	156	R			136,51	44,73	14,94	4,71	2,01	0,80	0,30	0,20	0,10	0,00			
		V			6,22	3,91	2,51	1,60	1,10	0,80	0,50	0,40	0,20	0,20			
2,8	168	R			157,27	51,45	17,15	5,42	2,31	0,90	0,40	0,20	0,10	0,00			
		V			6,62	4,21	2,71	1,71	1,20	0,80	0,60	0,40	0,30	0,20			
3	180	R			179,44	58,58	19,46	6,12	2,61	1,10	0,40	0,20	0,10	0,00			
		V			7,12	4,51	2,91	1,81	1,30	0,90	0,60	0,50	0,30	0,20	0,10		
3,2	192	R			203,01	66,20	21,97	6,92	3,01	1,20	0,50	0,20	0,10	0,00	0,00		
		V			7,62	4,81	3,11	1,91	1,40	1,00	0,60	0,50	0,30	0,20	0,10		
3,4	204	R			227,98	74,22	24,57	7,72	3,31	1,30	0,50	0,30	0,10	0,00	0,00		
		V			8,02	5,12	3,31	2,11	1,50	1,00	0,70	0,50	0,30	0,20	0,10		
3,6	216	R			254,46	82,75	27,38	8,53	3,71	1,50	0,60	0,30	0,10	0,00	0,00		
		V			8,53	5,52	3,51	2,21	1,50	1,10	0,70	0,60	0,30	0,20	0,10		
3,8	228	R			282,34	91,67	30,29	9,43	4,11	1,71	0,60	0,30	0,10	0,00	0,00		
		V			9,03	5,82	3,71	2,31	1,60	1,10	0,80	0,60	0,40	0,20	0,10		
4	240	R			311,63	101,10	33,40	10,43	4,51	1,81	0,70	0,40	0,10	0,00	0,00		
		V			9,53	6,12	3,91	2,41	1,71	1,20	0,80	0,60	0,40	0,20	0,20		
4,2	252	R			342,32	111,03	36,61	11,43	4,91	2,01	0,80	0,40	0,10	0,00	0,00		
		V			9,93	6,42	4,11	2,51	1,81	1,30	0,80	0,60	0,40	0,30	0,20		
4,4	264	R			374,52	121,26	39,92	12,44	5,32	2,21	0,80	0,40	0,10	0,00	0,00		
		V			10,43	6,72	4,31	2,71	1,91	1,30	0,90	0,70	0,40	0,30	0,20		
4,6	276	R				131,99	43,43	13,54	5,82	2,31	0,90	0,50	0,10	0,00	0,00		
		V				7,02	4,51	2,81	2,01	1,40	0,90	0,70	0,40	0,30	0,20		
4,8	288	R				143,23	47,14	14,64	6,32	2,51	1,00	0,50	0,20	0,10	0,00		
		V				7,32	4,71	2,91	2,11	1,40	1,00	0,70	0,50	0,30	0,20		
5	300	R				154,86	50,85	15,85	6,72	2,71	1,00	0,60	0,20	0,10	0,00		
		V				7,62	4,91	3,01	2,21	1,50	1,00	0,80	0,50	0,30	0,20		

ABBREVIATIONS

R Pressure loss [mbar/m]
V Flow Speed [m/s]

TEMPERATURE 60°C
 ROUGHNESS 0,007 mm
 DENSITY 983,2 kg/m³
 VISCOSITY 4,74x10⁻⁷ m²/s

CONTINUED >

FLOW		Temperature difference - ΔT (°C)													
(L/s)	(L/min)	DN	20	25	32	40	50	63	75	90	110	125	160	200	250
		THICKNESS	2,8	3,5	4,4	5,5	6,9	8,6	10,3	12,3	15,1	17,1	21,9	27,4	34,2
5,2	312	R				167,00	54,86	17,05	7,32	2,91	1,10	0,60	0,20	0,10	0,00
		V				7,92	5,12	3,21	2,21	1,50	1,00	0,80	0,50	0,30	0,20
5,4	324	R				179,54	58,88	18,25	7,82	3,21	1,20	0,60	0,20	0,10	0,00
		V				8,22	5,22	3,31	2,31	1,60	1,10	0,80	0,50	0,30	0,20
5,6	336	R				192,48	63,09	19,56	8,32	3,41	1,30	0,70	0,20	0,10	0,00
		V				8,53	5,42	3,41	2,41	1,71	1,10	0,90	0,50	0,30	0,20
5,8	348	R				205,92	67,50	20,86	8,93	3,61	1,40	0,70	0,20	0,10	0,00
		V				8,83	5,62	3,51	2,51	1,71	1,20	0,90	0,50	0,40	0,20
6	360	R				219,86	71,92	22,27	9,53	3,81	1,40	0,80	0,20	0,10	0,00
		V				9,13	5,82	3,61	2,61	1,81	1,20	0,90	0,60	0,40	0,20
6,2	372	R				234,20	76,63	23,67	10,13	4,11	1,50	0,80	0,20	0,10	0,00
		V				9,43	6,02	3,81	2,71	1,81	1,20	1,00	0,60	0,40	0,20
6,4	384	R				248,94	81,34	25,18	10,73	4,31	1,60	0,90	0,30	0,10	0,00
		V				9,73	6,22	3,91	2,81	1,91	1,30	1,00	0,60	0,40	0,20
6,6	396	R				264,19	86,26	26,58	11,33	4,61	1,71	0,90	0,30	0,10	0,00
		V				10,03	6,42	4,01	2,81	2,01	1,30	1,00	0,60	0,40	0,30
6,8	408	R					91,37	28,18	12,04	4,81	1,81	1,00	0,30	0,10	0,00
		V					6,62	4,11	2,91	2,01	1,40	1,10	0,60	0,40	0,30
7	420	R					96,59	29,79	12,64	5,12	1,91	1,00	0,30	0,10	0,00
		V					6,82	4,21	3,01	2,11	1,40	1,10	0,70	0,40	0,30
7,5	450	R					110,13	33,90	14,44	5,82	2,21	1,20	0,40	0,10	0,00
		V					7,32	4,61	3,21	2,21	1,50	1,20	0,70	0,50	0,30
8	480	R					124,67	38,31	16,25	6,52	2,51	1,30	0,40	0,10	0,00
		V					7,82	4,91	3,41	2,41	1,60	1,20	0,80	0,50	0,30
9	540	R					156,37	47,94	20,36	8,12	3,11	1,60	0,50	0,20	0,10
		V					8,73	5,52	3,91	2,71	1,81	1,40	0,80	0,50	0,30
10	600	R					191,47	58,58	24,77	9,93	3,71	2,01	0,60	0,20	0,10
		V					9,73	6,12	4,31	3,01	2,01	1,50	0,90	0,60	0,40
12	720	R					272,41	82,95	35,00	14,04	5,22	2,81	0,80	0,30	0,10
		V					11,74	7,32	5,22	3,61	2,41	1,91	1,10	0,70	0,50
14	840	R						111,53	46,94	18,76	7,02	3,71	1,10	0,40	0,10
		V						8,53	6,02	4,21	2,81	2,21	1,30	0,80	0,50
16	960	R						144,23	60,58	24,07	8,93	4,71	1,40	0,50	0,20
		V						9,73	6,92	4,81	3,21	2,51	1,50	1,00	0,60
18	1080	R						181,04	75,93	30,09	11,23	5,92	1,81	0,60	0,20
		V						10,93	7,72	5,42	3,61	2,81	1,71	1,10	0,70
20	1200	R							92,98	36,81	13,64	7,22	2,11	0,70	0,20
		V							8,63	6,02	4,01	3,11	1,91	1,20	0,80
22	1320	R							111,73	44,23	16,35	8,63	2,51	0,90	0,30
		V							9,53	6,52	4,41	3,41	2,11	1,30	0,80

ABBREVIATIONS

R Pressure loss [mbar/m]
 V Flow Speed [m/s]

TEMPERATURE 60°C
 ROUGHNESS 0,007 mm
 DENSITY 983,2 kg/m³
 VISCOSITY 4,74x10⁻⁷ m²/s

CONTINUED >

FLOW		Temperature difference - ΔT (°C)													
(L/s)	(L/min)	DN	20	25	32	40	50	63	75	90	110	125	160	200	250
		THICKNESS	2,8	3,5	4,4	5,5	6,9	8,6	10,3	12,3	15,1	17,1	21,9	27,4	34,2
24	1440	R							132,10	52,16	19,26	10,13	3,01	1,00	0,30
		V							10,33	7,12	4,81	3,71	2,31	1,40	0,90
26	1560	R							154,26	60,88	22,47	11,84	3,51	1,20	0,40
		V							11,23	7,72	5,22	4,01	2,51	1,60	1,00
28	1680	R							70,21	25,88	13,54	4,01	1,30	0,40	
		V							8,32	5,62	4,31	2,61	1,71	1,10	
30	1800	R							80,14	29,49	15,45	4,51	1,50	0,50	
		V							8,93	6,02	4,61	2,81	1,81	1,20	
32	1920	R							90,77	33,30	17,45	5,12	1,71	0,60	
		V							9,53	6,42	4,91	3,01	1,91	1,20	
34	2040	R							102,01	37,41	19,66	5,72	1,91	0,60	
		V							10,13	6,82	5,32	3,21	2,11	1,30	
36	2160	R								41,72	21,87	6,42	2,11	0,70	
		V								7,22	5,62	3,41	2,21	1,40	
38	2280	R								46,34	24,27	7,12	2,41	0,80	
		V								7,62	5,92	3,61	2,31	1,50	
40	2400	R								51,15	26,78	7,82	2,61	0,90	
		V								8,02	6,22	3,81	2,41	1,50	
42	2520	R								56,17	29,39	8,53	2,81	0,90	
		V								8,43	6,52	4,01	2,51	1,60	
44	2640	R								61,38	32,10	9,33	3,11	1,00	
		V								8,83	6,82	4,11	2,71	1,71	
46	2760	R								66,90	34,90	10,23	3,41	1,10	
		V								9,23	7,12	4,31	2,81	1,81	
48	2880	R								72,62	37,91	11,03	3,61	1,20	
		V								9,63	7,42	4,51	2,91	1,91	
50	3000	R								78,64	41,02	11,94	3,91	1,30	
		V								10,03	7,72	4,71	3,01	1,91	
60	3600	R									58,17	16,85	5,62	1,81	
		V									9,33	5,72	3,61	2,31	
70	4200	R									78,43	22,67	7,42	2,51	
		V									10,83	6,62	4,21	2,71	
80	4800	R										29,29	9,63	3,21	
		V										7,52	4,81	3,11	
90	5400	R											36,71	12,04	3,91
		V											8,53	5,42	3,51
100	6000	R											44,93	14,64	4,81
		V											9,43	6,02	3,91
150	9000	R												32,00	10,43
		V												9,13	5,82

ABBREVIATIONS

R Pressure loss [mbar/m]
 V Flow Speed [m/s]

LINEAR PRESSURE LOSS EQUATION

ΔP = R x L
 ΔP Linear pressure loss (Pa)
 R Pipe friction pressure gradient (Pa/m)
 L Pipe length (m)

PRESSURE LOSS

PP-R 100 + FG SDR 11 | ROMAKLIMA

PP-RCT 125 + FG SDR 11 | ROMAFASER CT

20°C

TEMPERATURE 20°C

ROUGHNESS 0,007 mm

DENSITY 998,2 kg/m³

VISCOSITY 1,004x10⁻⁶ m²/s

FLOW		Temperature difference - ΔT (°C)													
(L/s)	(L/min)	DN	20	25	32	40	50	63	75	90	110	125	160	200	250
		THICKNESS	2,8	3,5	2,9	3,7	4,6	5,8	6,8	8,2	10,0	11,4	14,6	18,2	22,7
0,01	0,6	R	0,05	0,02	0,01										
		V	0,05	0,03	0,02										
0,02	1,2	R	0,16	0,05	0,02	0,01									
		V	0,10	0,06	0,04	0,02									
0,03	1,8	R	0,32	0,10	0,03	0,01									
		V	0,15	0,09	0,06	0,04									
0,04	2,4	R	0,52	0,18	0,05	0,02	0,01								
		V	0,19	0,12	0,07	0,05	0,03								
0,05	3	R	0,76	0,26	0,08	0,03	0,01								
		V	0,24	0,15	0,09	0,06	0,04								
0,06	3,6	R	1,04	0,35	0,10	0,04	0,01								
		V	0,29	0,18	0,11	0,07	0,05								
0,07	4,2	R	1,35	0,45	0,14	0,05	0,02	0,01							
		V	0,34	0,21	0,13	0,08	0,05	0,03							
0,08	4,8	R	1,70	0,57	0,18	0,06	0,02	0,01							
		V	0,39	0,24	0,15	0,10	0,06	0,04							
0,09	5,4	R	2,09	0,70	0,22	0,07	0,03	0,01							
		V	0,44	0,28	0,17	0,11	0,07	0,04							
0,1	6	R	2,50	0,83	0,26	0,09	0,03	0,01							
		V	0,49	0,31	0,19	0,12	0,08	0,05							
0,15	9	R	4,99	1,66	0,51	0,18	0,06	0,02	0,01						
		V	0,73	0,46	0,28	0,18	0,11	0,07	0,05						
0,2	12	R	8,47	2,81	0,85	0,30	0,10	0,03	0,01	0,01					
		V	0,97	0,61	0,37	0,24	0,15	0,10	0,07	0,05					
0,3	18	R	17,41	5,74	1,73	0,61	0,21	0,07	0,03	0,01					
		V	1,46	0,92	0,56	0,36	0,23	0,14	0,10	0,07					
0,4	24	R	29,16	9,58	2,88	1,01	0,35	0,11	0,05	0,02	0,01				
		V	1,94	1,22	0,74	0,48	0,31	0,19	0,14	0,09	0,06				
0,5	30	R	43,63	14,28	4,27	1,50	0,52	0,18	0,07	0,03	0,01	0,01			
		V	2,43	1,53	0,93	0,60	0,38	0,24	0,17	0,12	0,08	0,06			
0,6	36	R	60,76	19,82	5,92	2,07	0,71	0,24	0,10	0,04	0,02	0,01			
		V	2,91	1,84	1,11	0,72	0,46	0,29	0,20	0,14	0,09	0,07			
0,7	42	R	80,50	26,17	7,80	2,73	0,93	0,31	0,13	0,05	0,02	0,01			
		V	3,40	2,14	1,30	0,84	0,54	0,34	0,24	0,16	0,11	0,09			
0,8	48	R	102,82	33,34	9,91	3,46	1,17	0,39	0,16	0,07	0,03	0,01			
		V	3,88	2,45	1,48	0,96	0,61	0,39	0,27	0,19	0,13	0,10			
0,9	54	R	127,69	41,30	12,26	4,26	1,45	0,48	0,21	0,08	0,03	0,02	0,01		
		V	4,37	2,75	1,67	1,08	0,69	0,43	0,30	0,21	0,14	0,11	0,07		
1,0	60	R	155,10	50,06	14,82	5,15	1,75	0,58	0,25	0,10	0,04	0,02	0,01		
		V	4,85	3,06	1,85	1,20	0,76	0,48	0,34	0,24	0,16	0,12	0,07		

ABBREVIATIONS

R Pressure loss [mbar/m]

V Flow Speed [m/s]

TEMPERATURE 20°C
 ROUGHNESS 0,007 mm
 DENSITY 998,2 kg/m³
 VISCOSITY 1,004x10⁻⁶ m²/s

CONTINUED >

FLOW		Temperature difference - ΔT (°C)													
(L/s)	(L/min)	DN	20	25	32	40	50	63	75	90	110	125	160	200	250
		THICKNESS	2,8	3,5	2,9	3,7	4,6	5,8	6,8	8,2	10,0	11,4	14,6	18,2	22,7
1,2	72	R	216,38	69,57	20,52	7,11	2,41	0,80	0,34	0,14	0,05	0,03	0,01		
		V	5,82	3,67	2,23	1,44	0,92	0,58	0,41	0,28	0,19	0,15	0,09		
1,4	84	R		92,37	27,15	9,40	3,18	1,05	0,45	0,18	0,07	0,04	0,01		
		V		4,28	2,60	1,68	1,07	0,67	0,47	0,33	0,22	0,17	0,10		
1,6	96	R		118,22	34,66	11,96	4,04	1,33	0,56	0,24	0,09	0,05	0,01	0,01	
		V		4,90	2,97	1,92	1,22	0,77	0,54	0,38	0,25	0,20	0,12	0,08	
1,8	108	R		147,08	43,00	14,81	4,99	1,64	0,70	0,30	0,11	0,06	0,02	0,01	
		V		5,51	3,34	2,16	1,38	0,87	0,61	0,42	0,28	0,22	0,13	0,09	
2,0	120	R			52,17	17,95	6,04	1,98	0,84	0,35	0,13	0,07	0,02	0,01	
		V			3,71	2,40	1,53	0,96	0,68	0,47	0,31	0,24	0,15	0,10	
2,2	132	R			62,19	21,35	7,18	2,35	1,00	0,42	0,16	0,08	0,03	0,01	
		V			4,08	2,64	1,68	1,06	0,74	0,52	0,35	0,27	0,16	0,10	
2,4	144	R			73,03	25,03	8,41	2,75	1,17	0,49	0,18	0,10	0,03	0,01	
		V			4,45	2,88	1,84	1,16	0,81	0,56	0,38	0,29	0,18	0,11	
2,6	156	R			84,69	28,99	9,72	3,18	1,35	0,56	0,22	0,11	0,04	0,01	
		V			4,82	3,11	1,99	1,25	0,88	0,61	0,41	0,32	0,19	0,12	
2,8	168	R			97,16	33,21	11,12	3,63	1,54	0,65	0,25	0,13	0,04	0,01	
		V			5,19	3,35	2,14	1,35	0,95	0,66	0,44	0,34	0,21	0,13	
3,0	180	R			110,45	37,70	12,61	4,11	1,74	0,73	0,28	0,15	0,05	0,02	0,01
		V			5,56	3,59	2,29	1,45	1,01	0,71	0,47	0,37	0,22	0,14	0,09
3,2	192	R			124,56	42,46	14,19	4,62	1,96	0,82	0,31	0,17	0,05	0,02	0,01
		V			5,94	3,83	2,45	1,54	1,08	0,75	0,50	0,39	0,24	0,15	0,10
3,4	204	R				47,49	15,85	5,16	2,18	0,91	0,35	0,18	0,06	0,02	0,01
		V				4,07	2,60	1,64	1,15	0,80	0,53	0,41	0,25	0,16	0,10
3,6	216	R				52,78	17,59	5,72	2,42	1,01	0,38	0,21	0,06	0,02	0,01
		V				4,31	2,75	1,73	1,22	0,85	0,57	0,44	0,27	0,17	0,11
3,8	228	R				58,33	19,42	6,31	2,67	1,12	0,42	0,23	0,07	0,02	0,01
		V				4,55	2,91	1,83	1,28	0,89	0,60	0,46	0,28	0,18	0,12
4,0	240	R				64,14	21,34	6,93	2,93	1,22	0,46	0,26	0,08	0,03	0,01
		V				4,79	3,06	1,93	1,35	0,94	0,63	0,49	0,30	0,19	0,12
4,2	252	R				70,22	23,34	7,57	3,20	1,33	0,50	0,28	0,08	0,03	0,01
		V				5,03	3,21	2,02	1,42	0,99	0,66	0,51	0,31	0,20	0,13
4,4	264	R				76,57	25,43	8,24	3,49	1,45	0,55	0,30	0,09	0,03	0,01
		V				5,27	3,37	2,12	1,49	1,03	0,69	0,54	0,33	0,21	0,13
4,6	276	R				83,17	27,59	8,94	3,77	1,57	0,59	0,33	0,10	0,03	0,01
		V				5,51	3,52	2,22	1,55	1,08	0,72	0,56	0,34	0,22	0,14
4,8	288	R				90,04	29,85	9,67	4,08	1,69	0,65	0,35	0,10	0,04	0,01
		V				5,75	3,67	2,31	1,62	1,13	0,75	0,59	0,36	0,23	0,15
5,0	300	R				97,16	32,19	10,41	4,39	1,82	0,70	0,38	0,11	0,04	0,01
		V				5,99	3,82	2,41	1,69	1,18	0,79	0,61	0,37	0,24	0,15

ABBREVIATIONS

R Pressure loss [mbar/m]
 V Flow Speed [m/s]

TEMPERATURE 20°C
 ROUGHNESS 0,007 mm
 DENSITY 998,2 kg/m³
 VISCOSITY 1,004x10⁻⁶ m²/s

CONTINUED >

FLOW		Temperature difference - ΔT (°C)													
(L/s)	(L/min)	DN	20	25	32	40	50	63	75	90	110	125	160	200	250
		THICKNESS	2,8	3,5	2,9	3,7	4,6	5,8	6,8	8,2	10,0	11,4	14,6	18,2	22,7
5,2	312	R					34,47	11,14	4,70	1,95	0,74	0,40	0,12	0,04	0,01
		V					3,98	2,51	1,76	1,22	0,82	0,63	0,39	0,25	0,16
5,4	324	R						11,94	5,03	2,09	0,80	0,43	0,13	0,04	0,02
		V						2,60	1,82	1,27	0,85	0,66	0,40	0,26	0,16
5,6	336	R						12,76	5,37	2,24	0,85	0,46	0,14	0,05	0,02
		V						2,70	1,89	1,32	0,88	0,68	0,42	0,27	0,17
5,8	348	R						13,61	5,73	2,38	0,90	0,49	0,15	0,05	0,02
		V						2,80	1,96	1,36	0,91	0,71	0,43	0,28	0,18
6,0	360	R						14,49	6,10	2,53	0,96	0,52	0,16	0,05	0,02
		V						2,89	2,03	1,41	0,94	0,73	0,45	0,29	0,18
6,2	372	R						15,39	6,47	2,69	1,01	0,55	0,16	0,06	0,02
		V						2,99	2,09	1,46	0,97	0,76	0,46	0,29	0,19
6,4	384	R						16,31	6,85	2,85	1,07	0,58	0,17	0,06	0,02
		V						3,08	2,16	1,50	1,01	0,78	0,48	0,30	0,19
6,6	396	R						17,25	7,25	3,01	1,13	0,61	0,18	0,06	0,02
		V						3,18	2,23	1,55	1,04	0,80	0,49	0,31	0,20
6,8	408	R						18,24	7,66	3,18	1,20	0,65	0,19	0,07	0,02
		V						3,28	2,30	1,60	1,07	0,83	0,51	0,32	0,21
7,0	420	R						19,24	8,08	3,35	1,27	0,68	0,20	0,07	0,02
		V						3,37	2,36	1,65	1,10	0,85	0,52	0,33	0,21
7,5	450	R						21,84	9,16	3,80	1,43	0,78	0,23	0,08	0,03
		V						3,61	2,53	1,76	1,18	0,91	0,56	0,36	0,23
8,0	480	R						24,61	10,31	4,27	1,61	0,87	0,27	0,09	0,03
		V						3,86	2,70	1,88	1,26	0,98	0,60	0,38	0,24
9,0	540	R						30,61	12,80	5,29	1,99	1,08	0,33	0,11	0,04
		V						4,34	3,04	2,12	1,41	1,10	0,67	0,43	0,27
10,0	600	R						37,22	15,55	6,42	2,42	1,31	0,40	0,13	0,05
		V						4,82	3,38	2,35	1,57	1,22	0,74	0,48	0,30
12,0	720	R						52,28	21,79	8,97	3,37	1,82	0,55	0,18	0,06
		V						5,78	4,05	2,82	1,89	1,46	0,89	0,57	0,36
14,0	840	R							29,00	11,92	4,46	2,41	0,72	0,25	0,08
		V							4,73	3,29	2,20	1,71	1,04	0,67	0,43
16,0	960	R							37,20	15,25	5,71	3,07	0,93	0,32	0,11
		V							5,40	3,76	2,52	1,95	1,19	0,76	0,49
18,0	1080	R							46,35	18,98	7,09	3,81	1,15	0,39	0,13
		V							6,08	4,23	2,83	2,19	1,34	1,34	0,55
20,0	1200	R								23,08	8,61	4,63	1,40	0,47	0,16
		V								4,70	3,14	2,44	1,49	0,95	0,61
25	1500	R								35,02	13,01	6,98	2,05	0,70	0,24
		V								5,88	3,93	3,05	1,86	1,19	0,76

ABBREVIATIONS

R Pressure loss [mbar/m]
 V Flow Speed [m/s]

TEMPERATURE 20°C
 ROUGHNESS 0,007 mm
 DENSITY 998,2 kg/m³
 VISCOSITY 1,004x10⁻⁶ m²/s

CONTINUED >

FLOW		Temperature difference - ΔT (°C)													
(L/s)	(L/min)	DN	20	25	32	40	50	63	75	90	110	125	160	200	250
		THICKNESS	2,8	3,5	2,9	3,7	4,6	5,8	6,8	8,2	10,0	11,4	14,6	18,2	22,7
30	1800	R									18,23	9,76	2,93	0,99	0,34
		V									4,72	3,66	2,23	1,43	0,91
35	2100	R									24,33	13,01	3,89	1,31	0,44
		V									5,50	4,27	2,61	1,29	1,06
40	2400	R										16,68	4,97	1,67	0,56
		V										4,88	2,98	1,90	1,22
45	2700	R										20,78	6,18	2,08	0,70
		V										5,49	3,38	2,14	1,37
50	3000	R											7,52	2,52	0,85
		V											3,72	2,38	1,52
55	3300	R											9,59	3,20	1,08
		V											4,25	2,71	1,73
60	3600	R											10,55	3,52	1,18
		V											4,47	2,85	1,82
65	3900	R											12,21	4,09	1,37
		V											4,84	3,09	1,98
70	4200	R											14,07	4,68	1,57
		V											5,21	3,33	2,13
75	4500	R											16,01	5,32	1,79
		V											5,59	3,57	2,28
80	4800	R											18,06	6,01	2,01
		V											5,95	3,81	2,43
90	5400	R												7,48	2,50
		V												4,28	2,74
100	6000	R												9,10	3,04
		V												4,76	3,04
110	6600	R												10,88	3,63
		V												5,23	3,35
120	7200	R												12,81	4,26
		V												5,71	3,65
130	7800	R													4,95
		V													3,95
140	8400	R													5,68
		V													4,35
150	9000	R													6,47
		V													4,65
160	9600	R													6,48
		V													4,97
170	10200	R													7,27
		V													5,27

ABBREVIATIONS

R Pressure loss [mbar/m]
 V Flow Speed [m/s]

LINEAR PRESSURE LOSS EQUATION

ΔP = R x L
 ΔP Linear pressure loss (Pa)
 R Pipe friction pressure gradient (Pa/m)
 L Pipe length (m)

PRESSURE LOSS

PP-R 100 + FG SDR 11 | ROMAKLIMA

PP-RCT 125 + FG SDR 11 | ROMAFASER CT

70°C

TEMPERATURE 70°C

ROUGHNESS 0,007 mm

DENSITY 977,7 kg/m³

VISCOSITY 0,41x10⁻⁶ m²/s

FLOW		Temperature difference - ΔT (°C)													
(L/s)	(L/min)	DN	20	25	32	40	50	63	75	90	110	125	160	200	250
		THICKNESS	2,8	3,5	2,9	3,7	4,6	5,8	6,8	8,2	10,0	11,4	14,6	18,2	22,7
0,01	0,6	R	0,04	0,01											
		V	0,05	0,03											
0,02	1,2	R	0,12	0,04	0,01										
		V	0,10	0,06	0,04										
0,03	1,8	R	0,23	0,08	0,02	0,01									
		V	0,15	0,09	0,06	0,04									
0,04	2,4	R	0,39	0,13	0,04	0,01									
		V	0,19	0,12	0,07	0,05									
0,05	3	R	0,58	0,19	0,06	0,02	0,01								
		V	0,24	0,15	0,09	0,06	0,04								
0,06	3,6	R	0,79	0,26	0,08	0,03	0,01								
		V	0,29	0,18	0,11	0,07	0,05								
0,07	4,2	R	1,04	0,35	0,10	0,04	0,01								
		V	0,34	0,21	0,13	0,08	0,05								
0,08	4,8	R	1,32	0,44	0,13	0,05	0,02	0,01							
		V	0,39	0,24	0,15	0,10	0,06	0,04							
0,09	5,4	R	1,63	0,54	0,16	0,06	0,02	0,01							
		V	0,44	0,28	0,17	0,11	0,07	0,04							
0,1	6	R	1,95	0,55	0,18	0,07	0,02	0,01							
		V	0,49	0,31	0,19	0,12	0,08	0,05							
0,15	9	R	4,08	1,35	0,41	0,15	0,05	0,02							
		V	0,73	0,46	0,28	0,18	0,12	0,08							
0,2	12	R	6,79	2,22	0,66	0,23	0,08	0,03	0,01						
		V	0,97	0,61	0,37	0,24	0,15	0,10	0,07						
0,3	18	R	14,21	4,61	1,37	0,48	0,16	0,05	0,02	0,01					
		V	1,46	0,92	0,56	0,36	0,23	0,14	0,10	0,07					
0,4	24	R	24,12	7,79	2,31	0,80	0,27	0,09	0,04	0,02	0,01				
		V	1,94	1,22	0,74	0,48	0,31	0,19	0,14	0,09	0,06				
0,5	30	R	36,46	11,72	3,45	1,20	0,41	0,13	0,06	0,02	0,01				
		V	2,43	1,51	0,93	0,60	0,38	0,24	0,17	0,12	0,08				
0,6	36	R	51,23	16,39	4,82	1,67	0,56	0,18	0,08	0,03	0,01	0,01			
		V	2,91	1,84	1,11	0,72	0,46	0,29	0,20	0,14	0,09	0,07			
0,7	42	R	68,38	21,81	6,38	2,20	0,74	0,24	0,10	0,04	0,02	0,01			
		V	3,40	2,14	1,30	0,84	0,54	0,34	0,24	0,16	0,11	0,09			
0,8	48	R	87,91	27,94	8,15	2,81	0,95	0,31	0,13	0,05	0,02	0,01			
		V	3,88	2,45	1,48	0,96	0,61	0,39	0,27	0,19	0,13	0,10			
0,9	54	R	109,83	34,82	10,13	3,48	1,17	0,39	0,16	0,07	0,03	0,01			
		V	4,37	2,75	1,67	1,08	0,69	0,43	0,30	0,21	0,14	0,11			
1,0	60	R	134,10	42,40	12,31	4,21	1,42	0,46	0,19	0,08	0,03	0,02	0,01		
		V	4,85	3,06	1,85	1,20	0,76	0,48	0,34	0,24	0,16	0,12	0,07		

ABBREVIATIONS

R Pressure loss [mbar/m]

V Flow Speed [m/s]

TEMPERATURE 70°C
ROUGHNESS 0,007 mm
DENSITY 977,7 kg/m³
VISCOSITY 0,41x10⁻⁶ m²/s

CONTINUED >

FLOW		Temperature difference - ΔT (°C)													
(L/s)	(L/min)	DN	20	25	32	40	50	63	75	90	110	125	160	200	250
		THICKNESS	2,8	3,5	2,9	3,7	4,6	5,8	6,8	8,2	10,0	11,4	14,6	18,2	22,7
1,2	72	R	189,72	59,72	17,26	5,89	1,97	0,64	0,27	0,11	0,04	0,02	0,01		
		V	5,82	3,67	2,23	1,44	0,92	0,58	0,41	0,28	0,19	0,15	0,09		
1,4	84	R		79,90	23,00	7,83	2,62	0,86	0,36	0,15	0,06	0,03	0,01		
		V		4,28	2,60	1,68	1,07	0,67	0,47	0,33	0,22	0,17	0,10		
1,6	96	R		102,92	29,52	10,02	3,34	1,08	0,46	0,19	0,07	0,04	0,01		
		V		4,90	2,97	1,95	1,22	0,77	0,54	0,38	0,25	0,20	0,12		
1,8	108	R		128,78	36,82	12,47	4,14	1,34	0,57	0,23	0,09	0,05	0,01	0,01	
		V		5,51	3,34	2,16	1,38	0,87	0,61	0,42	0,28	0,22	0,13	0,09	
2,0	120	R			44,90	15,18	5,03	1,63	0,68	0,29	0,11	0,06	0,02	0,01	
		V			3,71	2,40	1,53	0,96	0,68	0,47	0,31	0,24	0,15	0,10	
2,2	132	R			53,76	18,13	6,00	1,93	0,81	0,34	0,13	0,07	0,02	0,01	
		V			4,08	2,64	1,68	1,06	0,74	0,52	0,35	0,27	0,16	0,10	
2,4	144	R			63,39	21,34	7,04	2,27	0,96	0,40	0,15	0,08	0,02	0,01	
		V			4,45	2,88	1,84	1,16	0,81	0,56	0,38	0,29	0,18	0,11	
2,6	156	R			73,79	24,80	8,17	2,64	1,11	0,46	0,17	0,09	0,03	0,01	
		V			4,82	3,11	1,99	1,25	0,88	0,61	0,41	0,32	0,19	0,12	
2,8	168	R			84,96	28,50	9,38	3,01	1,26	0,53	0,20	0,11	0,03	0,01	
		V			5,19	3,35	2,14	1,35	0,95	0,66	0,44	0,34	0,21	0,13	
3,0	180	R			96,90	32,45	10,67	3,43	1,44	0,60	0,22	0,12	0,04	0,01	
		V			5,56	3,59	2,29	1,45	1,01	0,71	0,47	0,37	0,22	0,14	
3,2	192	R			109,62	36,66	12,03	3,86	1,62	0,67	0,25	0,13	0,04	0,01	
		V			5,94	3,83	2,45	1,54	1,08	0,75	0,50	0,39	0,24	0,15	
3,4	204	R				41,12	13,48	4,32	1,81	0,75	0,29	0,15	0,05	0,02	
		V				4,07	2,60	1,64	1,15	0,80	0,53	0,41	0,25	0,16	
3,6	216	R				45,82	15,00	4,80	2,01	0,83	0,32	0,17	0,05	0,02	
		V				4,31	2,75	1,73	1,22	0,85	0,57	0,44	0,27	0,17	
3,8	228	R				50,77	16,60	5,30	2,22	0,92	0,35	0,18	0,06	0,02	
		V				4,55	2,91	1,83	1,28	0,89	0,60	0,46	0,28	0,18	
4,0	240	R				55,96	18,27	5,83	2,44	1,01	0,38	0,20	0,06	0,02	
		V				4,79	3,06	1,93	1,35	0,94	0,63	0,49	0,30	0,19	0,12
4,2	252	R				61,40	20,03	6,39	2,67	1,10	0,42	0,22	0,07	0,02	0,01
		V				5,03	3,21	2,02	1,42	0,99	0,66	0,51	0,31	0,20	0,13
4,4	264	R				67,09	21,87	6,97	2,91	1,20	0,45	0,24	0,07	0,02	0,01
		V				5,27	3,37	2,12	1,49	1,03	0,69	0,54	0,33	0,21	0,13
4,6	276	R				73,02	23,78	7,57	3,16	1,30	0,49	0,26	0,08	0,03	0,01
		V				5,51	3,52	2,22	1,55	1,08	0,72	0,56	0,34	0,22	0,14
4,8	288	R				79,20	25,77	8,19	3,42	1,40	0,53	0,29	0,09	0,03	0,01
		V				5,75	3,67	2,31	1,62	1,13	0,75	0,59	0,36	0,23	0,15
5,0	300	R				85,63	27,83	8,85	3,69	1,52	0,57	0,31	0,09	0,03	0,01
		V				5,99	3,82	2,41	1,69	1,18	0,79	0,61	0,37	0,24	0,15

ABBREVIATIONS

R Pressure loss [mbar/m]
V Flow Speed [m/s]

TEMPERATURE 70°C
 ROUGHNESS 0,007 mm
 DENSITY 977,7 kg/m³
 VISCOSITY 0,41x10⁻⁶ m²/s

CONTINUED >

FLOW		Temperature difference - ΔT (°C)														
(L/s)	(L/min)	DN	20	25	32	40	50	63	75	90	110	125	160	200	250	
		THICKNESS	2,8	3,5	2,9	3,7	4,6	5,8	6,8	8,2	10,0	11,4	14,6	18,2	22,7	
5,2	312	R					30,01	9,53	3,96	1,63	0,61	0,33	0,10	0,03	0,01	
		V					3,94	2,51	1,76	1,22	0,82	0,63	0,39	0,25	0,16	
5,4	324	R					32,23	10,22	4,26	1,75	0,65	0,36	0,11	0,04	0,01	
		V					4,13	2,60	1,82	1,27	0,85	0,66	0,40	0,26	0,16	
5,6	336	R					34,52	10,94	4,55	1,87	0,70	0,38	0,11	0,04	0,01	
		V					4,28	2,70	1,89	1,32	0,88	0,68	0,42	0,27	0,17	
5,8	348	R					36,91	11,69	4,86	2,00	0,74	0,41	0,12	0,04	0,01	
		V					4,44	2,80	1,96	1,36	0,91	0,71	0,43	0,28	0,18	
6,0	360	R					39,35	12,46	5,18	2,13	0,79	0,43	0,13	0,04	0,01	
		V					4,59	2,89	2,03	1,41	0,94	0,73	0,45	0,29	0,18	
6,2	372	R					41,89	13,25	5,50	2,26	0,85	0,46	0,14	0,05	0,02	
		V					4,74	2,99	2,09	1,46	0,97	0,76	0,46	0,29	0,19	
6,4	384	R					44,50	14,06	5,84	2,39	0,90	0,48	0,14	0,05	0,02	
		V					4,90	3,08	2,16	1,50	1,01	0,78	0,48	0,30	0,19	
6,6	396	R					47,18	15,21	6,19	2,54	0,95	0,51	0,15	0,05	0,02	
		V					5,05	3,18	2,23	1,55	1,04	0,80	0,49	0,31	0,20	
6,8	408	R					49,94	15,76	6,53	2,68	1,00	0,54	0,16	0,05	0,02	
		V					5,20	3,28	2,30	1,60	1,07	0,83	0,51	0,32	0,21	
7,0	420	R					52,78	16,65	6,90	2,82	1,06	0,57	0,17	0,06	0,02	
		V					5,35	3,37	2,36	1,65	1,10	0,85	0,52	0,33	0,21	
7,5	450	R					60,21	18,96	7,85	3,21	1,20	0,64	0,19	0,06	0,02	
		V					5,74	3,61	2,53	1,76	1,18	0,91	0,56	0,36	0,23	
8,0	480	R						21,43	8,87	3,63	1,36	0,72	0,21	0,07	0,02	
		V						3,86	2,70	1,88	1,26	0,98	0,60	0,38	0,24	
9,0	540	R						26,79	11,06	4,51	1,68	0,91	0,28	0,09	0,03	
		V						4,34	3,04	2,12	1,41	1,10	0,67	0,43	0,27	
10,0	600	R						32,73	13,48	5,49	2,04	1,09	0,33	0,11	0,04	
		V						4,82	3,38	2,35	1,57	1,22	0,74	0,48	0,30	
12,0	720	R						46,33	19,03	7,73	2,86	1,54	0,46	0,15	0,05	
		V						5,78	4,05	2,82	1,89	1,46	0,89	0,57	0,36	
14,0	840	R							25,51	10,33	3,82	2,04	0,61	0,20	0,07	
		V							4,73	3,29	2,20	1,71	1,04	0,67	0,43	
16,0	960	R							32,90	13,30	4,90	2,62	0,78	0,26	0,09	
		V							5,40	3,76	2,52	1,95	1,19	0,76	0,49	
18,0	1080	R								16,63	6,11	3,26	0,97	0,33	0,11	
		V								4,32	2,83	2,19	1,34	0,86	0,55	
20,0	1200	R								20,32	7,46	3,97	1,18	0,40	0,13	
		V								4,70	3,14	2,44	1,49	0,95	0,61	
25	1500	R									31,15	11,39	6,05	1,79	0,60	0,18
		V									5,88	3,93	3,05	1,86	1,19	0,73

ABBREVIATIONS

R Pressure loss [mbar/m]
 V Flow Speed [m/s]

TEMPERATURE 70°C
 ROUGHNESS 0,007 mm
 DENSITY 977,7 kg/m³
 VISCOSITY 0,41x10⁻⁶ m²/s

CONTINUED >

FLOW		Temperature difference - ΔT (°C)													
(L/s)	(L/min)	DN	20	25	32	40	50	63	75	90	110	125	160	200	250
		THICKNESS	2,8	3,5	2,9	3,7	4,6	5,8	6,8	8,2	10,0	11,4	14,6	18,2	22,7
30	1800	R									16,08	8,53	2,52	0,84	0,21
		V									4,72	3,66	2,23	1,43	0,79
35	2100	R									20,15	10,89	3,09	1,04	0,36
		V									5,34	4,17	2,52	1,62	1,03
40	2400	R									14,74	4,32	1,43	0,40	
		V									4,88	2,98	1,90	1,09	
45	2700	R									17,89	5,17	1,72	0,57	
		V									5,40	3,28	2,10	1,34	
50	3000	R											6,58	2,17	0,62
		V											3,72	2,38	1,40
55	3300	R											7,65	2,52	0,84
		V											4,04	2,58	1,64
60	3600	R											9,30	3,06	0,90
		V											4,47	2,85	1,70
65	3900	R											10,59	3,48	1,14
		V											4,78	3,06	1,95
70	4200	R											12,48	4,10	1,21
		V											5,21	3,33	2,01
75	4500	R											13,98	4,58	1,51
		V											5,54	3,54	2,25
80	4800	R											16,12	5,27	1,58
		V											5,95	3,81	2,31
90	5400	R												6,59	1,74
		V												4,28	2,43
100	6000	R												8,06	2,17
		V												4,76	2,74
110	6600	R												9,67	2,65
		V												5,23	3,04
120	7200	R												11,42	3,17
		V												5,71	3,35
130	7800	R												13,32	3,74
		V												6,18	3,65
140	8400	R													4,35
		V													3,95
150	9000	R													5,01
		V													4,26
160	9600	R													6,47
		V													4,87
170	10200	R													7,27
		V													5,17

ABBREVIATIONS

R Pressure loss [mbar/m]
 V Flow Speed [m/s]

LINEAR PRESSURE LOSS EQUATION

ΔP = R x L
 ΔP Linear pressure loss (Pa)
 R Pipe friction pressure gradient (Pa/m)
 L Pipe length (m)

PRESSURE LOSS

PP-RCT 125 + FG SDR 17 | ROMAKLIMA CT

20°C

TEMPERATURE 20°C

ROUGHNESS 0,007 mm

DENSITY 998,2 kg/m³

VISCOSITY 1,004x10⁻⁶ m²/s

FLOW		Temperature difference - ΔT (°C)							
(L/s)	(L/min)	DN	125	160	200	250	315	355	400
		THICKNESS	7,4	9,5	11,9	14,8	18,7	21,1	23,7
5	300	R	0,20						
		V	0,51						
6	360	R	0,27						
		V	0,61						
7	420	R	0,36	0,11					
		V	0,71	0,40					
8	480	R	0,46	0,14					
		V	0,81	0,51					
9	540	R	0,57	0,17	0,06				
		V	0,91	0,61	0,40				
10	600	R	0,68	0,21	0,07				
		V	1,01	0,61	0,40				
12	720	R	0,95	0,29	0,10				
		V	1,21	0,81	0,51				
14	840	R	1,26	0,38	0,13				
		V	1,52	0,91	0,61				
16	960	R	1,60	0,49	0,17	0,06			
		V	1,72	1,01	0,61	0,40			
18	1080	R	1,98	0,60	0,21	0,07			
		V	1,92	1,11	0,71	0,51			
20	1200	R	2,40	0,73	0,25	0,08			
		V	2,12	1,31	0,81	0,51			
25	1500	R	3,62	1,09	0,37	0,13			
		V	2,63	1,57	1,06	0,66			
30	1800	R	5,05	1,52	0,52	0,18	0,06		
		V	3,13	1,92	1,21	0,81	0,51		
35	2100	R	6,71	2,02	0,69	0,23	0,08		
		V	3,64	2,27	1,46	0,91	0,61		
40	2400	R	8,58	2,58	0,87	0,30	0,10	0,05	
		V	4,14	2,53	1,62	1,01	0,71	0,51	
45	2700	R	10,67	3,20	1,08	0,37	0,12	0,07	
		V	4,75	2,88	1,87	1,16	0,76	0,61	
50	3000	R	12,97	3,88	1,31	0,44	0,15	0,08	0,05
		V	5,25	3,23	2,02	1,31	0,81	0,61	0,51
55	3300	R	15,49	4,63	1,56	0,53	0,17	0,10	0,05
		V	5,76	3,48	2,27	1,46	0,91	0,71	0,56
60	3600	R	18,22	5,43	1,83	0,62	0,20	0,11	0,06
		V	6,26	3,84	2,42	1,62	1,01	0,71	0,61
65	3900	R	21,16	6,30	2,12	0,72	0,23	0,13	0,09
		V	6,77	4,19	2,68	1,72	1,06	0,81	0,66

ABBREVIATIONS

R Pressure loss [mbar/m]

V Flow Speed [m/s]

TEMPERATURE 20°C
 ROUGHNESS 0,007 mm
 DENSITY 998,2 kg/m³
 VISCOSITY 1,004x10⁻⁶ m²/s

CONTINUED >

FLOW		Temperature difference - ΔT (°C)							
(L/s)	(L/min)	DN	125	160	200	250	315	355	400
		THICKNESS	7,4	9,5	11,9	14,8	18,7	21,1	23,7
70	4200	R	24,30	7,23	2,43	0,82	0,27	0,15	0,08
		V	7,37	4,44	2,83	1,82	1,11	0,91	0,71
75	4500	R	27,66	8,22	2,76	0,93	0,30	0,17	0,10
		V	7,88	4,80	3,08	1,97	1,21	1,01	0,76
80	4800	R	31,21	9,26	3,23	1,09	0,36	0,20	0,11
		V	8,38	5,15	3,23	2,12	1,31	1,01	0,81
85	5100	R	34,98	10,37	3,61	1,22	0,39	0,22	0,12
		V	8,89	5,45	3,43	2,22	1,41	1,11	0,91
90	5400	R	38,95	11,53	4,01	1,35	0,44	0,25	0,14
		V	9,39	5,76	3,64	2,32	1,52	1,21	0,91
95	5700	R	43,13	12,76	4,44	1,49	0,49	0,27	0,15
		V	10,00	6,06	3,94	2,53	1,62	1,21	1,01
100	6000	R	47,51	14,04	4,88	1,64	0,53	0,30	0,17
		V	10,50	6,36	4,14	2,63	1,62	1,31	1,01
110	6600	R		16,78	5,82	1,95	0,63	0,33	0,20
		V		7,07	4,55	2,93	1,82	1,41	1,11
120	7200	R		19,75	6,84	2,29	0,74	0,42	0,23
		V		7,68	4,95	3,13	2,02	1,52	1,21
130	7800	R		22,95	7,94	2,66	0,86	0,48	0,27
		V		8,28	5,35	3,43	2,12	1,72	1,31
140	8400	R		26,38	9,12	3,05	0,99	0,55	0,31
		V		8,99	5,76	3,64	2,32	1,82	1,41
150	9000	R		30,04	10,37	3,46	1,12	0,63	0,35
		V		9,60	6,16	3,94	2,53	1,92	1,52
160	9600	R		33,94	11,70	3,91	1,26	0,71	0,40
		V		10,20	6,57	4,14	2,63	2,12	1,62
170	10200	R			13,10	4,37	1,41	0,79	0,44
		V			6,97	4,44	2,83	2,22	1,72
180	10800	R			14,59	4,86	1,57	0,88	0,49
		V			7,37	4,75	2,93	2,32	1,82
190	11400	R			16,15	5,37	1,74	0,97	0,54
		V			7,78	4,95	3,13	2,42	1,92
200	12000	R			17,78	5,91	1,91	1,06	0,60
		V			8,18	5,25	3,33	2,63	2,02
210	12600	R			19,49	6,48	2,09	1,16	0,65
		V			8,59	5,45	3,43	2,73	2,12
220	13200	R			21,27	7,06	2,28	1,27	0,71
		V			8,99	5,76	3,64	2,83	2,22
230	13800	R			23,13	7,68	2,47	1,38	0,77
		V			9,39	6,06	3,84	3,03	2,32

ABBREVIATIONS

- R Pressure loss [mbar/m]
- V Flow Speed [m/s]

TEMPERATURE 20°C
 ROUGHNESS 0,007 mm
 DENSITY 998,2 kg/m³
 VISCOSITY 1,004x10⁻⁶ m²/s

CONTINUED >

FLOW		Temperature difference - ΔT (°C)							
(L/s)	(L/min)	DN	125	160	200	250	315	355	400
		THICKNESS	7,4	9,5	11,9	14,8	18,7	21,1	23,7
240	14400	R			25,07	8,31	2,68	1,49	0,83
		V			9,80	6,26	3,94	3,13	2,42
250	15000	R			27,08	8,97	2,89	1,61	0,90
		V			10,20	6,57	4,14	3,23	2,53
260	15600	R				9,65	3,10	1,73	0,97
		V				6,77	4,24	3,33	2,63
270	16200	R				10,36	3,33	1,85	1,04
		V				7,07	4,44	3,54	2,73
280	16800	R				11,09	3,56	1,98	1,11
		V				7,37	4,65	3,64	2,83
290	17400	R				11,85	3,80	2,11	1,18
		V				7,58	4,75	3,74	2,93
300	18000	R				12,63	4,05	2,25	1,26
		V				7,88	4,95	3,94	3,03
310	18600	R				13,43	4,31	2,39	1,34
		V				8,08	5,15	4,04	3,13
320	19200	R				14,26	4,57	2,54	1,42
		V				8,38	5,25	4,14	3,23
330	19800	R				15,11	4,84	2,69	1,50
		V				8,69	5,45	4,24	3,33
340	20400	R				15,98	5,12	2,84	1,59
		V				8,89	5,66	4,44	3,43
350	21000	R				16,88	5,40	3,00	1,67
		V				9,19	5,76	4,55	3,54
360	21600	R				17,80	5,70	3,16	1,76
		V				9,39	5,96	4,65	3,64
370	22200	R				18,75	6,32	3,33	1,86
		V				9,70	6,06	4,85	3,74
380	22800	R				19,72	6,30	3,49	1,95
		V				10,00	6,26	4,95	3,84
390	23400	R					6,62	3,67	2,05
		V					6,46	5,05	3,94
400	24000	R					6,94	3,85	2,15
		V					6,57	5,15	4,14
410	24600	R					7,27	4,03	2,25
		V					6,77	5,35	4,24
420	25200	R					7,60	4,21	2,35
		V					6,97	5,45	4,34
430	25800	R					7,94	4,40	2,45
		V					7,07	5,56	4,44

ABBREVIATIONS

R Pressure loss [mbar/m]
 V Flow Speed [m/s]

TEMPERATURE 20°C
 ROUGHNESS 0,007 mm
 DENSITY 998,2 kg/m³
 VISCOSITY 1,004x10⁻⁶ m²/s

CONTINUED >

FLOW		Temperature difference - ΔT (°C)							
(L/s)	(L/min)	DN	125	160	200	250	315	355	400
		THICKNESS	7,4	9,5	11,9	14,8	18,7	21,1	23,7
440	26400	R					8,29	4,59	2,56
		V					7,27	5,76	4,55
450	27000	R					8,65	4,79	2,67
		V					7,47	5,86	4,65
460	27600	R					9,02	4,99	2,78
		V					7,58	5,96	4,75
470	28200	R					9,39	5,20	2,90
		V					7,78	6,06	4,85
480	28800	R					9,77	5,41	3,01
		V					7,88	6,26	4,95
490	29400	R					10,16	5,62	3,13
		V					8,08	6,36	5,05
500	30000	R					10,55	5,84	3,25
		V					8,28	6,51	5,15
525	31500	R					11,57	6,40	3,56
		V					8,66	6,82	5,40
550	33000	R					12,62	6,98	3,89
		V					9,09	7,17	5,66
575	34500	R					13,73	7,59	4,22
		V					9,49	7,47	5,91
600	36000	R					14,88	8,22	4,57
		V					9,90	7,78	6,16
625	37500	R					16,07	8,88	4,94
		V					10,30	8,13	6,41
650	39000	R						9,56	5,31
		V						8,48	6,67
675	40500	R						10,26	5,70
		V						8,74	6,92
700	42000	R						10,99	6,11
		V						9,09	7,17
725	43500	R						11,74	6,52
		V						9,44	7,42
750	45000	R						12,52	6,95
		V						9,70	7,68
775	46500	R						13,32	7,39
		V						10,05	7,93
800	48000	R							7,85
		V							8,18

ABBREVIATIONS

R Pressure loss [mbar/m]
 V Flow Speed [m/s]

LINEAR PRESSURE LOSS EQUATION

$\Delta P = R \times L$
 ΔP Linear pressure loss (Pa)
 R Pipe friction pressure gradient (Pa/m)
 L Pipe length (m)

PRESSURE LOSS

PP-RCT 125 + FG SDR 17 | ROMAKLIMA CT

70°C

TEMPERATURE 70°C
 ROUGHNESS 0,007 mm
 DENSITY 977,7 kg/m³
 VISCOSITY 0,41x10⁻⁶ m²/s

FLOW		Temperature difference - ΔT (°C)							
(L/s)	(L/min)	DN	125	160	200	250	315	355	400
		THICKNESS	7,4	9,5	11,9	14,8	18,7	21,1	23,7
5	300	R	0,15						
		V	0,51						
6	360	R	0,21						
		V	0,61						
7	420	R	0,28	0,09					
		V	0,71	0,40					
8	480	R	0,36	0,11					
		V	0,81	0,51					
9	540	R	0,45	0,13	0,06				
		V	0,91	0,61	0,40				
10	600	R	0,54	0,16	0,07				
		V	1,01	0,61	0,40				
12	720	R	0,75	0,23	0,10				
		V	1,21	0,81	0,51				
14	840	R	1,00	0,30	0,13				
		V	1,52	0,91	0,61				
16	960	R	1,29	0,38	0,16	0,06			
		V	1,72	1,01	0,61	0,40			
18	1080	R	1,60	0,48	0,20	0,07			
		V	1,92	1,11	0,71	0,51			
20	1200	R	1,95	0,58	0,25	0,08			
		V	2,12	1,31	0,81	0,51			
25	1500	R	2,96	0,89	0,30	0,11			
		V	2,63	1,57	1,06	0,66			
30	1800	R	4,17	1,23	0,41	0,14	0,05		
		V	3,13	1,92	1,21	0,81	0,51		
35	2100	R	5,58	1,65	0,55	0,18	0,06		
		V	3,64	2,27	1,46	0,91	0,61		
40	2400	R	7,19	2,11	0,71	0,24	0,08	0,04	
		V	4,14	2,53	1,62	1,01	0,71	0,51	
45	2700	R	8,99	2,64	0,88	0,29	0,10	0,05	
		V	4,75	2,88	1,87	1,16	0,76	0,61	
50	3000	R	10,99	3,22	1,07	0,36	0,12	0,06	0,04
		V	5,25	3,23	2,02	1,31	0,81	0,61	0,51
55	3300	R	13,19	3,85	1,28	0,43	0,14	0,08	0,04
		V	5,76	3,48	2,27	1,46	0,91	0,71	0,56
60	3600	R	15,58	4,54	1,51	0,50	0,16	0,09	0,05
		V	6,26	3,84	2,42	1,62	1,01	0,71	0,61
65	3900	R	18,17	5,29	1,75	0,58	0,19	0,10	0,06
		V	6,77	4,19	2,68	1,72	1,06	0,81	0,66

ABBREVIATIONS

- R Pressure loss [mbar/m]
- V Flow Speed [m/s]

TEMPERATURE 70°C
 ROUGHNESS 0,007 mm
 DENSITY 977,7 kg/m³
 VISCOSITY 0,41x10⁻⁶ m²/s

CONTINUED >

FLOW		Temperature difference - ΔT (°C)							
(L/s)	(L/min)	DN	125	160	200	250	315	355	400
		THICKNESS	7,4	9,5	11,9	14,8	18,7	21,1	23,7
70	4200	R	20,95	6,09	2,01	0,67	0,22	0,12	0,07
		V	7,37	4,44	2,83	1,82	1,11	0,91	0,71
75	4500	R	23,93	6,94	2,29	0,76	0,24	0,14	0,08
		V	7,88	4,80	3,08	1,97	1,21	1,01	0,76
80	4800	R	27,10	7,92	2,69	0,89	0,29	0,16	0,09
		V	8,38	5,15	3,23	2,12	1,31	1,01	0,81
85	5100	R	30,46	8,90	3,01	1,00	0,32	0,18	0,10
		V	8,89	5,45	3,43	2,22	1,41	1,11	0,91
90	5400	R	34,02	9,93	3,36	1,11	0,36	0,20	0,11
		V	9,39	5,76	3,64	2,32	1,52	1,21	0,91
95	5700	R	37,78	11,01	3,72	1,23	0,39	0,22	0,12
		V	10,00	6,06	3,94	2,53	1,62	1,21	1,01
100	6000	R	41,73	12,15	4,10	1,35	0,43	0,24	0,13
		V	10,50	6,36	4,14	2,63	1,62	1,31	1,01
110	6600	R		14,59	4,91	1,62	0,52	0,29	0,16
		V		7,07	4,55	2,93	1,82	1,41	1,11
120	7200	R		17,25	5,80	1,91	0,61	0,34	0,19
		V		7,68	4,95	3,13	2,02	1,52	1,21
130	7800	R		20,13	6,76	2,22	0,71	0,39	0,22
		V		8,28	5,35	3,43	2,12	1,72	1,31
140	8400	R		23,22	7,79	2,55	0,81	0,45	0,25
		V		8,99	5,76	3,64	2,32	1,82	1,41
150	9000	R		26,54	8,89	2,91	0,93	5,13	0,29
		V		9,60	6,16	3,94	2,53	1,92	1,52
160	9600	R		30,08	10,06	3,29	1,05	0,58	0,32
		V		10,20	6,57	4,14	2,63	2,12	1,62
170	10200	R			11,30	3,69	1,17	0,65	0,36
		V			6,97	4,44	2,83	2,22	1,72
180	10800	R			12,62	4,12	1,31	0,72	0,40
		V			7,37	4,75	2,93	2,32	1,82
190	11400	R			14,00	4,56	1,45	0,80	0,44
		V			7,78	4,95	3,13	2,42	1,92
200	12000	R			15,46	5,03	1,59	0,88	0,49
		V			8,18	5,25	3,33	2,63	2,02
210	12600	R			16,98	5,53	1,75	0,97	0,54
		V			8,59	5,45	3,43	2,73	2,12
220	13200	R			18,58	6,04	1,91	1,05	0,59
		V			8,99	5,76	3,64	2,83	2,22
230	13800	R			20,25	6,58	2,08	1,15	0,64
		V			9,39	6,06	3,84	3,03	2,32

ABBREVIATIONS

R Pressure loss [mbar/m]
 V Flow Speed [m/s]

TEMPERATURE 70°C
 ROUGHNESS 0,007 mm
 DENSITY 977,7 kg/m³
 VISCOSITY 0,41x10⁻⁶ m²/s

CONTINUED >

FLOW		Temperature difference - ΔT (°C)							
(L/s)	(L/min)	DN	125	160	200	250	315	355	400
		THICKNESS	7,4	9,5	11,9	14,8	18,7	21,1	23,7
240	14400	R			21,99	7,14	2,25	1,24	0,69
		V			9,80	6,26	3,94	3,13	2,42
250	15000	R			23,80	7,72	2,43	1,34	0,74
		V			10,20	6,57	4,14	3,23	2,53
260	15600	R				8,33	2,62	1,45	0,80
		V				6,77	4,24	3,33	2,63
270	16200	R				8,95	2,82	1,55	0,86
		V				7,07	4,44	3,54	2,73
280	16800	R				9,60	3,02	1,66	0,92
		V				7,37	4,65	3,64	2,83
290	17400	R				10,27	3,23	1,78	0,98
		V				7,58	4,75	3,74	2,93
300	18000	R				10,97	3,45	1,90	1,05
		V				7,88	4,95	3,94	3,03
310	18600	R				11,68	3,67	2,02	1,12
		V				8,08	5,15	4,04	3,13
320	19200	R				12,62	3,90	2,14	1,19
		V				8,38	5,25	4,14	3,23
330	19800	R				13,18	4,13	2,27	1,26
		V				8,69	5,45	4,24	3,33
340	20400	R				13,97	4,38	2,41	1,33
		V				8,89	5,66	4,44	3,43
350	21000	R				14,77	4,63	2,54	1,41
		V				9,19	5,76	4,55	3,54
360	21600	R				15,60	4,88	2,68	1,48
		V				9,39	5,96	4,65	3,64
370	22200	R				16,45	5,15	2,83	1,56
		V				9,70	6,06	4,85	3,74
380	22800	R				17,32	5,42	2,97	1,64
		V				10,00	6,26	4,95	3,84
390	23400	R					5,70	3,13	1,73
		V					6,46	5,05	3,94
400	24000	R					5,98	3,28	1,81
		V					6,57	5,15	4,14
410	24600	R					6,27	3,44	1,90
		V					6,77	5,35	4,24
420	25200	R					6,57	3,60	1,99
		V					6,97	5,45	4,34
430	25800	R					6,87	3,77	2,08
		V					7,07	5,56	4,44

ABBREVIATIONS

R Pressure loss [mbar/m]
 V Flow Speed [m/s]

TEMPERATURE 70°C
 ROUGHNESS 0,007 mm
 DENSITY 977,7 kg/m³
 VISCOSITY 0,41x10⁻⁶ m²/s

CONTINUED >

FLOW		Temperature difference - ΔT (°C)							
(L/s)	(L/min)	DN	125	160	200	250	315	355	400
		THICKNESS	7,4	9,5	11,9	14,8	18,7	21,1	23,7
440	26400	R					7,18	3,94	2,17
		V					7,27	5,76	4,55
450	27000	R					7,50	4,11	2,27
		V					7,47	5,86	4,65
460	27600	R					7,83	4,29	2,37
		V					7,58	5,96	4,75
470	28200	R					8,16	4,47	2,46
		V					7,78	6,06	4,85
480	28800	R					8,50	4,65	2,57
		V					7,88	6,26	4,95
490	29400	R					8,84	4,84	2,67
		V					8,08	6,36	5,05
500	30000	R					9,19	5,03	2,77
		V					8,28	6,51	5,15
525	31500	R					10,10	5,53	3,05
		V					8,66	6,82	5,40
550	33000	R					11,05	6,04	3,33
		V					9,09	7,17	5,66
575	34500	R					12,05	6,58	3,63
		V					9,49	7,47	5,91
600	36000	R					13,08	7,15	3,93
		V					9,90	7,78	6,16
625	37500	R					14,16	7,73	4,25
		V					10,30	8,13	3,23
650	39000	R						8,34	4,59
		V						8,48	6,67
675	40500	R						8,97	4,93
		V						8,74	6,92
700	42000	R						9,63	5,29
		V						9,09	7,17
725	43500	R						10,31	5,66
		V						9,44	7,42
750	45000	R						11,00	6,04
		V						9,70	7,68
775	46500	R						11,73	6,44
		V						10,05	7,93
800	48000	R							6,85
		V							8,18

ABBREVIATIONS

R Pressure loss [mbar/m]
 V Flow Speed [m/s]

LINEAR PRESSURE LOSS EQUATION

$\Delta P = R \times L$
 ΔP Linear pressure loss (Pa)
 R Pipe friction pressure gradient (Pa/m)
 L Pipe length (m)

PRESSURE LOSS

PE-RT / AL / PE-RT | HELIKLIMA

Ø 16 - 20 mm | 10°C*

TEMPERATURE 10°C*
 ROUGHNESS 0,007 mm
 DENSITY 998,2 kg/m³
 VISCOSITY 1,004x10⁻⁶ m²/s

FLOW		Temperature difference - ΔT (°C)			
(L/s)	(L/min)	DN	16	18	20
		THICKNESS	2,00	2,00	2,00
0,01	0,00	V	0,09	0,06	0,05
		R	0,22	0,11	0,07
0,02	1,20	V	0,18	0,34	0,11
		R	0,69	0,13	0,21
0,03	1,80	V	0,27	0,66	0,16
		R	1,36	0,19	0,41
0,04	2,40	V	0,35	1,07	0,21
		R	2,21	0,26	0,66
0,05	3,00	V	0,44	1,56	0,26
		R	3,23	0,32	0,97
0,06	3,60	V	0,53	2,13	0,32
		R	4,41	0,39	1,32
0,07	4,20	V	0,62	2,78	0,37
		R	5,75	0,45	1,72
0,08	4,80	V	0,71	3,49	0,42
		R	7,23	0,52	2,16
0,09	5,40	V	0,8	4,28	0,48
		R	8,86	0,58	1,91
0,10	6,00	V	0,88	5,13	0,53
		R	10,63	0,65	3,17
0,15	9,00	V	1,33	9,38	0,79
		R	21,49	1,00	6,39
0,20	12,00	V	1,77	13,63	1,06
		R	35,52	1,35	10,54
0,25	15,00	V	2,21		1,32
		R	52,55		15,56
0,30	18,00	V	2,65	22,13	1,59
		R	72,43	2,05	21,41
0,35	21,00	V	3,09		1,85
		R	95,07		28,07
0,40	24,00	V	3,54	30,63	2,12
		R	120,39	2,75	35,52
0,45	27,00	V	3,98		2,38
		R	148,33		43,72
0,50	30,00	V	4,42	39,13	2,65
		R	178,83	3,45	52,67

FLOW		Temperature difference - ΔT (°C)			
(L/s)	(L/min)	DN	16	18	20
		THICKNESS	2,00	2,00	2,00
0,55	33,00	V	4,86		2,91
		R	211,85		62,35
0,60	36,00	V	5,31	47,63	3,18
		R	247,33	4,15	72,74
0,65	39,00	V	5,75		3,44
		R	285,24		83,84
0,70	42,00	V	6,19	56,13	3,71
		R	325,56	4,85	95,64
0,75	45,00	V	6,63		3,97
		R	368,25		108,13
0,80	48,00	V	7,07		4,42
		R	413,27		121,29
0,85	51,00	V			4,5
		R			135,12
0,90	54,00	V			4,77
		R			149,62
0,95	57,00	V			5,03
		R			164,77
1,00	60,00	V			5,3
		R			180,57
1,05	63,00	V			5,56
		R			197,02
1,10	66,00	V			5,83
		R			214,11
1,15	69,00	V			6,09
		R			231,84
1,20	72,00	V			6,36
		R			250,19
1,25	75,00	V			6,62
		R			269,17
1,30	78,00	V			6,89
		R			288,77
1,35	81,00	V			7,15
		R			308,99

* Correction factor for other water temperatures:

ABBREVIATIONS

R Pressure loss [mbar/m] V Flow Speed [m/s]

Water Temperature (°C)	10	15	20	25	30	35	40	45	50	55	60
Conversion Factor	1,0	0,98	0,97	0,95	0,94	0,93	0,92	0,9	0,89	0,87	0,86

PRESSURE LOSS

PE-RT / AL / PE-RT | HELIKLIMA

Ø 25 - 50 mm | 10°C*

TEMPERATURE 10°C*
 ROUGHNESS 0,007 mm
 DENSITY 998,2 kg/m³
 VISCOSITY 1,004x10⁻⁶ m²/s

FLOW		Temperature difference - ΔT (°C)				
(L/s)	(L/min)	DN	25	32	40	50
		THICKNESS	2,50	3,00	4,00	4,50
0,10	6,00	V	0,32	0,19	0,12	0,08
		R	0,95	0,28	0,1	0,03
0,20	12,00	V	0,64	0,38	0,25	0,15
		R	3,15	0,91	0,34	0,11
0,30	18,00	V	0,95	0,57	0,37	0,23
		R	6,38	1,84	0,69	0,21
0,40	24,00	V	1,27	0,75	0,5	0,3
		R	10,55	3,03	1,13	0,65
0,50	30,00	V	1,59	0,94	0,62	0,38
		R	15,62	4,48	1,67	0,52
0,60	36,00	V	1,91	1,13	0,75	0,45
		R	21,55	6,17	2,3	0,71
0,70	42,00	V	2,23	1,32	0,87	0,53
		R	28,3	8,1	3,01	0,93
0,80	48,00	V	2,55	1,51	0,99	0,61
		R	35,86	10,25	3,81	1,17
0,90	54,00	V	2,86	1,7	1,12	0,68
		R	44,2	12,63	4,69	1,44
1,00	60,00	V	3,18	1,88	1,24	0,76
		R	53,3	15,22	5,65	1,73
1,30	78,00	V	4,14	2,45	1,62	0,98
		R	85,08	24,24	8,99	2,76
1,40	84,00	V	4,46	2,64	1,74	1,06
		R	97,12	27,66	10,25	3,14
1,50	90,00	V	4,77	2,83	1,87	1,14
		R	109,88	31,28	11,59	3,55
1,60	96,00	V	50,9	3,01	1,99	1,21
		R	123,33	35,09	13	3,98
1,70	102,00	V		3,2	2,11	1,29
		R		39,1	14,48	4,43
1,80	108,00	V		3,39	2,24	1,36
		R		43,3	16,03	4,9
1,90	114,00	V		3,58	2,36	1,44
		R		47,69	17,65	5,4
2,00	120,00	V		3,77	2,49	1,51
		R		52,27	19,34	5,91
2,10	126,00	V		3,96	2,61	1,59
		R		57,04	21,1	6,45
2,20	132,00	V		4,14	2,74	1,67
		R		61,99	22,92	7

FLOW		Temperature difference - ΔT (°C)				
(L/s)	(L/min)	DN	25	32	40	50
		THICKNESS	2,50	3,00	4,00	4,50
2,30	138,00	V		4,33	2,86	1,74
		R		67,13	24,82	7,58
2,40	144,00	V		4,52	2,98	1,82
		R		72,45	26,78	8,18
2,50	150,00	V		4,71	3,11	1,89
		R		77,96	28,81	8,79
2,60	156,00	V		4,9	3,23	1,97
		R		83,64	30,9	9,43
2,70	162,00	V		5,09	3,39	2,05
		R		89,5	33,06	10,09
2,80	168,00	V			3,48	2,12
		R			35,28	10,76
2,90	174,00	V			3,61	2,2
		R			37,57	11,46
3,00	180,00	V			3,73	2,27
		R			39,93	12,17
3,50	210,00	V			4,35	2,65
		R			52,65	16,04
4,00	240,00	V			4,97	3,03
		R			66,93	20,37
4,50	270,00	V			5,6	3,41
		R			82,73	25,17
5,00	300,00	V				3,79
		R				30,41
5,50	330,00	V				4,17
		R				36,09
6,00	360,00	V				4,54
		R				42,22
6,50	390,00	V				4,92
		R				48,77
7,00	420,00	V				5,3
		R				55,74
7,50	450,00	V				5,68
		R				63,13
8,00	480,00	V				6,06
		R				70,94
8,50	510,00	V				6,44
		R				79,16
9,00	540,00	V				6,82
		R				87,78

ABBREVIATIONS

R Pressure loss [mbar/m] V Flow Speed [m/s]

* Correction factor for other water temperatures:

Water Temperature (°C)	10	15	20	25	30	35	40	45	50	55	60
Conversion Factor	1,0	0,98	0,97	0,95	0,94	0,93	0,92	0,9	0,89	0,87	0,86

PRESSURE LOSS

PE-RT / AL / PE-RT | HELIKLIMA

Ø 63 - 110 mm | 10°C*

TEMPERATURE 10°C*
 ROUGHNESS 0,007 mm
 DENSITY 998,2 kg/m³
 VISCOSITY 1,004x10⁻⁶ m²/s

FLOW		Temperature difference - ΔT (°C)				
(L/s)	(L/min)	DN	63	75	90	110
		THICKNESS	6,00	7,50	8,50	10,00
1,00	60,00	V	0,49	0,35	0,24	0,16
		R	0,61	0,28	0,11	0,04
1,25	75,00	V	0,61	0,44	0,30	0,20
		R	0,91	0,42	0,17	0,06
1,50	90,00	V	0,76	0,53	0,36	0,24
		R	1,25	0,58	0,23	0,08
1,75	105,00	V	0,86	0,62	0,42	0,28
		R	1,65	0,76	0,30	0,11
2,00	120,00	V	0,98	0,71	0,48	0,31
		R	2,08	0,96	0,38	0,14
2,25	135,00	V	1,10	0,80	0,54	0,35
		R	2,57	1,18	0,46	0,17
2,50	150,00	V	1,22	0,88	0,60	0,39
		R	3,10	1,43	0,56	0,21
2,75	165,00	V	1,35	0,97	0,66	0,43
		R	3,67	1,69	0,66	0,24
3,00	180,00	V	1,47	1,06	0,72	0,47
		R	4,28	1,97	0,77	0,28
3,25	195,00	V	1,59	1,15	0,78	0,51
		R	4,94	2,27	0,89	0,33
3,50	210,00	V	1,71	1,24	0,84	0,55
		R	5,64	2,59	1,01	0,37
3,75	225,00	V	1,84	1,33	0,90	0,59
		R	6,38	2,93	1,15	0,42
4,00	240,00	V	1,96	1,41	0,96	0,63
		R	7,16	3,29	1,29	0,47
4,25	255,00	V	2,08	1,50	1,02	0,67
		R	7,98	3,66	1,43	0,53
4,50	270,00	V	2,20	1,59	1,08	0,71
		R	8,84	4,06	1,59	0,58
4,75	285,00	V	2,33	1,68	1,13	0,75
		R	9,73	4,47	1,75	0,64
5,00	300,00	V	2,45	1,77	1,19	0,79
		R	10,67	4,90	1,92	0,70
6,00	360,00	V	2,94	2,12	1,43	0,94
		R	14,80	6,79	2,65	0,97
7,00	420,00	V	3,43	2,48	1,67	1,10
		R	19,53	8,95	3,49	1,28
8,00	480,00	V	3,92	2,83	1,91	1,26
		R	24,84	11,38	4,44	1,63
9,00	540,00	V	4,41	3,18	2,15	1,41
		R	30,71	14,07	5,49	2,01

FLOW		Temperature difference - ΔT (°C)				
(L/s)	(L/min)	DN	63	75	90	110
		THICKNESS	6,00	7,50	8,50	10,00
10,00	600,00	V	4,90	3,54	2,39	1,57
		R	37,15	17,01	6,63	2,43
11,00	660,00	V	5,38	3,89	2,63	1,73
		R	44,13	20,20	7,87	2,88
12,00	720,00	V		4,24	2,87	1,89
		R		23,63	9,21	3,37
13,00	780,00	V		4,60	3,11	2,04
		R		27,31	10,63	3,89
14,00	840,00	V		4,95	3,34	2,20
		R		31,23	12,16	4,45
15,00	900,00	V		5,31	3,58	2,36
		R		35,38	13,77	5,03
16,00	960,00	V		5,66	3,82	2,52
		R		39,77	15,47	5,65
17,00	1020,00	V		6,01	4,06	2,67
		R		44,39	17,27	6,31
18,00	1080,00	V			4,30	2,83
		R			19,15	6,99
19,00	1140,00	V			4,54	2,99
		R			21,12	7,71
20,00	1200,00	V			4,78	3,14
		R			23,17	8,46
21,00	1260,00	V			5,02	3,30
		R			25,31	9,24
22,00	1320,00	V			5,26	3,46
		R			27,54	10,05
23,00	1380,00	V			5,50	3,62
		R			29,86	10,89
24,00	1440,00	V			5,73	3,77
		R			32,25	11,77
25,00	1500,00	V				3,93
		R				12,67
26,00	1560,00	V				4,09
		R				13,60
27,00	1620,00	V				4,24
		R				14,57
28,00	1680,00	V				4,40
		R				15,56
29,00	1740,00	V				4,56
		R				16,58
30,00	1800,00	V				4,72
		R				17,63

* Correction factor for other water temperatures:

Water Temperature (°C)	10	15	20	25	30	35	40	45	50	55	60
Conversion Factor	1,0	0,98	0,97	0,95	0,94	0,93	0,92	0,9	0,89	0,87	0,86

ABBREVIATIONS

R Pressure loss [mbar/m] V Flow Speed [m/s]

PRESSURE LOSS

PE-Xa & PE-Xa EVOH | PEXROMA & PEROMA EVOH

70°C*

TEMPERATURE 70°C
 ROUGHNESS 0,007 mm
 DENSITY 977,7 kg/m³
 VISCOSITY 0,41x10⁻⁶ m²/s

FLOW		Temperature difference - ΔT (°C)				
(L/s)	(L/min)	DN	16,00	20,00	25,00	32,00
		THICKNESS	1,80	1,90	2,30	2,90
0,01	300	V	0,13	0,03	0,01	
		R	0,08	0,05	0,03	
0,02	360	V	0,43	0,11	0,04	0,01
		R	0,17	0,10	0,06	0,04
0,03	420	V	0,90	0,24	0,08	0,02
		R	0,25	0,15	0,09	0,06
0,04	480	V	1,51	0,40	0,13	0,04
		R	0,33	0,19	0,12	0,07
0,05	540	V	2,26	0,59	0,19	0,05
		R	0,41	0,24	0,15	0,09
0,06	600	V	3,14	0,82	0,27	0,07
		R	0,50	0,29	0,18	0,11
0,07	720	V	4,14	1,09	0,35	0,10
		R	0,58	0,34	0,21	0,13
0,08	840	V	5,26	1,38	0,45	0,12
		R	0,66	0,39	0,25	0,15
0,09	960	V	6,51	1,71	0,52	0,15
		R	0,75	0,44	0,28	0,17
0,1	1080	V	7,87	2,07	0,66	0,18
		R	0,83	0,49	0,31	0,19
0,15	1200	V	16,32	4,30	1,37	0,38
		R	1,24	0,73	0,46	0,28
0,2	1500	V	27,39	7,23	2,28	0,64
		R	1,66	0,97	0,61	0,37
0,3	1800	V	56,84	15,03	4,68	1,32
		R	2,48	1,46	0,92	0,56
0,4	2100	V	95,40	25,25	7,81	2,22
		R	3,31	1,94	1,22	0,74
0,5	2400	V	142,57	37,77	11,62	3,31
		R	4,14	2,43	1,53	0,93
0,6	2700	V	197,95	52,48	16,07	4,60
		R	4,97	2,91	1,84	1,11
0,7	3000	V	261,26	69,31	21,13	6,07
		R	5,80	3,40	2,14	1,30
0,8	3300	V	332,26	88,19	26,80	7,71
		R	6,63	3,88	2,45	1,48
0,9	3600	V	410,74	109,07	33,04	9,53
		R	7,45	4,37	2,75	1,67
1	3900	V		131,90	39,85	11,51
		R		4,85	3,06	1,86
1,2	4200	V		156,65	47,21	13,66
		R		5,34	3,37	2,04

FLOW		Temperature difference - ΔT (°C)				
(L/s)	(L/min)	DN	16,00	20,00	25,00	32,00
		THICKNESS	1,80	1,90	2,30	2,90
1,4	4500	V		183,28	55,11	15,97
		R		5,82	3,67	2,23
1,6	4800	V		211,76	63,54	18,44
		R		6,31	3,98	2,41
1,8	5100	V		242,05	72,85	21,06
		R		6,79	4,28	2,60
2	5400	V			81,95	23,84
		R			4,59	2,78
2,2	5700	V			91,92	26,77
		R			4,90	2,97
2,4	6000	V			102,38	29,85
		R			5,20	3,15
2,6	6600	V			113,33	33,08
		R			5,51	3,34
2,8	7200	V			124,77	36,45
		R			5,81	3,52
3	7800	V			136,68	39,97
		R			6,12	3,71
3,2	8400	V			149,07	43,63
		R			6,43	3,90
3,4	9000	V			161,93	47,43
		R			6,73	4,08
3,6	9600	V				51,38
		R				4,27
3,8	10200	V				55,46
		R				4,45
4	10800	V				59,68
		R				4,64
4,2	11400	V				64,03
		R				4,82
4,4	12000	V				68,52
		R				5,01
4,6	12600	V				73,15
		R				5,19
4,8	13200	V				77,91
		R				5,38
5	13800	V				82,80
		R				5,57

* Correction factor for other water temperatures:

Water Temperature (°C)	10	20	30	40	50	60	70	80	90
Conversion Factor	1,25	1,20	1,14	1,10	1,05	1,02	1,00	0,98	0,95

ABBREVIATIONS

R Pressure loss [mbar/m] V Flow Speed [m/s]

PRESSURE LOSS

PE-RT & PE-RT EVOH | ROMAPLUS & ROMAPLUS EVOH

70°C*

TEMPERATURE 70°C
 ROUGHNESS 0,007 mm
 DENSITY 977,7 kg/m³
 VISCOSITY 0,41x10⁻⁶ m²/s

FLOW		Temperature difference - ΔT (°C)				
(L/s)	(L/min)	DN	16,00	20,00	25,00	32,00
		THICKNESS	1,80	1,90	2,30	2,90
0,01	300	V	0,13	0,03	0,01	
		R	0,08	0,05	0,03	
0,02	360	V	0,43	0,11	0,04	0,01
		R	0,17	0,10	0,06	0,04
0,03	420	V	0,90	0,24	0,08	0,02
		R	0,25	0,15	0,09	0,06
0,04	480	V	1,51	0,40	0,13	0,04
		R	0,33	0,19	0,12	0,07
0,05	540	V	2,26	0,59	0,19	0,05
		R	0,41	0,24	0,15	0,09
0,06	600	V	3,14	0,82	0,27	0,07
		R	0,50	0,29	0,18	0,11
0,07	720	V	4,14	1,09	0,35	0,10
		R	0,58	0,34	0,21	0,13
0,08	840	V	5,26	1,38	0,45	0,12
		R	0,66	0,39	0,25	0,15
0,09	960	V	6,51	1,71	0,52	0,15
		R	0,75	0,44	0,28	0,17
0,1	1080	V	7,87	2,07	0,66	0,18
		R	0,83	0,49	0,31	0,19
0,15	1200	V	16,32	4,30	1,37	0,38
		R	1,24	0,73	0,46	0,28
0,2	1500	V	27,39	7,23	2,28	0,64
		R	1,66	0,97	0,61	0,37
0,3	1800	V	56,84	15,03	4,68	1,32
		R	2,48	1,46	0,92	0,56
0,4	2100	V	95,40	25,25	7,81	2,22
		R	3,31	1,94	1,22	0,74
0,5	2400	V	142,57	37,77	11,62	3,31
		R	4,14	2,43	1,53	0,93
0,6	2700	V	197,95	52,48	16,07	4,60
		R	4,97	2,91	1,84	1,11
0,7	3000	V	261,26	69,31	21,13	6,07
		R	5,80	3,40	2,14	1,30
0,8	3300	V	332,26	88,19	26,80	7,71
		R	6,63	3,88	2,45	1,48
0,9	3600	V	410,74	109,07	33,04	9,53
		R	7,45	4,37	2,75	1,67
1	3900	V		131,90	39,85	11,51
		R		4,85	3,06	1,86
1,2	4200	V		156,65	47,21	13,66
		R		5,34	3,37	2,04

FLOW		Temperature difference - ΔT (°C)				
(L/s)	(L/min)	DN	16,00	20,00	25,00	32,00
		THICKNESS	1,80	1,90	2,30	2,90
1,4	4500	V		183,28	55,11	15,97
		R		5,82	3,67	2,23
1,6	4800	V		211,76	63,54	18,44
		R		6,31	3,98	2,41
1,8	5100	V		242,05	72,85	21,06
		R		6,79	4,28	2,60
2	5400	V			81,95	23,84
		R			4,59	2,78
2,2	5700	V			91,92	26,77
		R			4,90	2,97
2,4	6000	V			102,38	29,85
		R			5,20	3,15
2,6	6600	V			113,33	33,08
		R			5,51	3,34
2,8	7200	V			124,77	36,45
		R			5,81	3,52
3	7800	V			136,68	39,97
		R			6,12	3,71
3,2	8400	V			149,07	43,63
		R			6,43	3,90
3,4	9000	V			161,93	47,43
		R			6,73	4,08
3,6	9600	V				51,38
		R				4,27
3,8	10200	V				55,46
		R				4,45
4	10800	V				59,68
		R				4,64
4,2	11400	V				64,03
		R				4,82
4,4	12000	V				68,52
		R				5,01
4,6	12600	V				73,15
		R				5,19
4,8	13200	V				77,91
		R				5,38
5	13800	V				82,80
		R				5,57

* Correction factor for other water temperatures:

Water Temperature (°C)	10	20	30	40	50	60	70	80	90
Conversion Factor	1,25	1,20	1,14	1,10	1,05	1,02	1,00	0,98	0,95

ABBREVIATIONS

R Pressure loss [mbar/m] V Flow Speed [m/s]

LEAK TEST | WATER

DESCRIPTION OF INSTALLATION

Description of installation _____

Installation Sanitary Hot Water Cold Water
 Heating Other

PROJECT N°.

Address _____

Province _____

Zip code _____ Country _____

CONTRACTOR

Name _____

Address _____

Province _____

Zip code _____ Country _____

Email _____

INSTALLER

Name _____

Address _____

Province _____

Zip code _____ Country _____

Email _____

MATERIAL AND CHARACTERISTICS SELECTION OF THE TEST PRESSURE

MATERIAL	SERIES	TEST PRESSURE (bar)	COLOUR	SELECT W/ X
HELYSYSTEM PP-R 100 SDR 6	S2.5	15	● ●	<input type="checkbox"/>
HELYSYSTEM PP-R 100 SDR 7,4	S3.2	15	●	<input type="checkbox"/>
ROMAFASER PP-R 100 + FG SDR 7,4	S3.2	15	● ●	<input type="checkbox"/>
ROMAKLIMA PP-R 100 + FG SDR 11	S5.0	9	●	<input type="checkbox"/>
ROMAFASER PP-R 100 + FG SDR 7,4 ANTI-UV	S3.2	15	●	<input type="checkbox"/>
ROMAFASER CT PP-RCT 125 + FG SDR 11	S5.0	9	●	<input type="checkbox"/>
ROMAKLIMA CT PP-RCT 125 + FG SDR 17	S8.0	6	●	<input type="checkbox"/>
RED FIRE PP-R 100 + FG SDR 11	S5.0	9	●	<input type="checkbox"/>
HELIKLIMA PE-RT / AL / PE-RT	-	15	<input type="radio"/>	<input type="checkbox"/>
PEXROMA & PEXROMA EVOH PE-Xa & PE-Xa EVOH	-	9	<input type="radio"/>	<input type="checkbox"/>
ROMAPLUS & ROMAPLUS EVOH PE-RT & PE-RT EVOH	-	9	<input type="radio"/>	<input type="checkbox"/>

Diameters 20 25 32 40 50 63 75 90
 110 125 160 200 250 315 355 400

Colours ● Green ● Blue ● Black ● Red

PREPARING INSTALLATION

Before starting the test, purge the system in order to remove all existing air from the installation.

1st TEST PHASE

Starting Time _____ Temperature and steady-state condition reached

1 - During **10 minutes** increase to Test Pressure selected;

Time _____

2 - Apply selected Test Pressure for **10 more minutes**;

Time _____

3 - **10 more minutes** of Test Pressure;

Time _____

4 - Continue for additional **30 minutes** at the above registered pressure);

Time _____

2nd TEST PHASE

Time _____ Temperature and steady-state condition reached

5 - During **2 hours** apply the pressure obtained during the 1st test phase;

Time _____

(Register the value read on the manometer _____ bar)

3rd TEST PHASE

6 - Maintain pressure obtained in the 2nd phase of the test during 24 hours.

Time _____ Temperature and steady-state condition reached

(Register the value read on the manometer _____ bar)

ATTENTION

The test should be repeated
During the test no faults can occur

Pipeline pressure _____ bar

Placement of the pressure reducing valve
(Applicable if necessary)

COMMENTS

INSTALLER

Signature of the installer

Place, Date

SIGNATURE OF THE HELIROMA REPRESENTATIVE

Signature of the HELIROMA representative
(when present during test procedures)

Note: Please return this form completed via e-mail: tecnico@heliroma.pt.
After analysis, an opinion will be issued with regards to the results obtained.

LEAK TEST | COMPRESSED AIR OR INERT GAS

DESCRIPTION OF INSTALLATION

Description of installation _____

Installation Sanitary Hot Water Cold Water
 Heating Other

PROJECT N°.

Address _____

Province _____

Zip code _____ Country _____

CONTRACTOR

Name _____

Address _____

Province _____

Zip code _____ Country _____

Email _____

INSTALLER

Name _____

Address _____

Province _____

Zip code _____ Country _____

Email _____

MATERIAL AND CHARACTERISTICS

HELIKLIMA/ PE-RT / AL / PE-RT PE-Xa PE-RT

Diameters 16 18 20 25 32 40 50 63

75 90 110

System Pressure _____ bar

Environment temperature _____ °C

Test medium temperature _____ °C

Line volume _____ L

Test medium Oil-free compressed air Nitrogen Carbon dioxide

Distribution system was testes as a complete system in _____ sub-sections

Note 1: All lines must be closed with metal plugs, caps, washers or blind flanges. Appliances, pressure vessels or water heaters must be disconnected from the pipes. A visual inspection of all pipe connections for professional execution was carried out.

PREPARING INSTALLATION

1st TEST PHASE | Leak Test

Pressure 150 mbar

Temperature and steady-state condition reached

Time up to 100 litres line volume must be at least 120 min, for every additional 100 litres, the test time must be increased by 20 minutes

Test time _____ minutes

No pressure drop was detected during the 1st test phase

2nd TEST PHASE | Load Test

Pressure: $d_e \leq 63$ mm max 3 bar

$d_e > 63$ mm max 1 bar

Temperature and steady-state condition reached

Test time: 10 minutes

No pressure drop was detected during the 2nd test phase

Piping system is tight

NOTE

The explanations and descriptions in the current at HELIORMA technical documentation must be observed

COMMENTS

INSTALLER

Signature of the installer

Place, Date

SIGNATURE OF THE HELIORMA REPRESENTATIVE

Signature of the HELIORMA representative
(when present during test procedures)

Note 2: Please return this form completed via e-mail: tecnico@heliroma.pt. After analysis, an opinion will be issued with regards to the results obtained.

GENERAL SALE CONDITIONS

General Information

- Sales of HELIROMA SA products are governed by the special conditions of each supply, by these general conditions and by the applicable law.
- The acceptance of the products and / or goods marketed by HELIROMA implies, without reservation, these conditions. Their knowledge is the customer's full responsibility. Any conditions contrary to these will not be accepted or will be subject to negotiation.

Orders

- All order requests must be made to HELIROMA in writing;
- All orders to be accepted by HELIROMA will be subject to written confirmation and in case of divergence, will prevail the confirmation from HELIROMA;
- All orders will be processed with the rounded quantities of a box, laced or roll, according to the requested items;
- Orders below € 1,500 and over € 1,000 will be delivered to the customer, to be paid on delivery;
- Orders worth more than € 1,500 will be delivered by HELIROMA, only valid for the National market, limited to continental territory;
- HELIROMA reserves the right not to accept orders below € 1,000;
- For all shipments, orders must be quantitatively controlled on the number of packages at the time of delivery;
- The formulation of the order to HELIROMA assumes that the customer is bound to these conditions of sale, without any reservation, considering that any clauses to the contrary contained in the orders are not valid.

Prices

The current price list is subject to change without notice and prices are subject to the applicable VAT rate.

Taxes:

- Taxes and / or charges inherent to the Export are the sole responsibility of the customer.

Example:

- Customs duties;
- Import Orders;
- VAT;
- Insurance, etc.

Payment conditions

Unless otherwise expressly agreed in writing by both parties, the trading conditions that apply to all our supplies are as follows:

Financial Discounts

- 0.5% Prompt Payment (invoices up to max. 8 days) 0% for payment beyond 8 days;
- All payments that exceed the invoice due date are subject to commercial interest at the applicable legal rate.

Credit

The credit terms and payment term will be defined by the Credit Department in writing and the non-compliance will result in immediate suspension of credit dispatches, as well as cancellation of any deal under special conditions and consequent communication to the credit company. For the first 2 orders the payment condition will be prompt payment.

Property Reservation

Products sold are the property of HELIROMA SA until fully paid by the buyer, regardless of whether they are sold or given to third parties.

Transport

Products and / or goods are shipped at the client's risk at all times when not shipped with HELIROMA SA's own fleet or by a carrier hired by it.

No dispute regarding the choice of carrier and / or means of transport will be accepted. At the express request of the customer indicated on the order form, special protective packaging may be provided, subject to acceptance of such order by HELIROMA and consequent extra charge of packaging costs to the customer.

Warranty

Materials supplied by HELIROMA are warranted in accordance with applicable law, and HELIROMA's warranty is limited to a manufacturing defect. The warranty is also limited to the replacement / repair of products found to be defective, and any deficiencies caused by misuse or misuse of the products are not covered. The warranty is also limited to the use of the product as directed by the HELIROMA technical catalogue.

Complaints

All complaints related to delivery and quantity of our products must be reported within 24 hours upon the reception. After this period the goods are deemed to be properly and correctly delivered. Complaints regarding the lack of packages must be referenced in the accompanying documents in order to be accepted. All claims related to product quality must be reported within the legally defined deadlines. The maximum period of communication to HELIROMA SA is 48 hours. All complaints will be analyzed on a case by case basis and HELIROMA reserves the right not to assume them.

Returns

Any return will only be accepted with the prior written consent of HELIROMA SA and never more than 15 days from the date of delivery.

For accepted returns the material must be in perfect condition for subsequent sale and also included in HELIROMA's commercialization range. Returned materials must be in intact packaging, show no signs of use and be accompanied by the corresponding Return Note. All returns accepted will be subject to a minimum devaluation of 35% and in some cases may be higher. Such devaluation will always be previously communicated to the customer. The customer will expressly inform HELIROMA of its acceptance. The cost of shipping accepted returns is always responsibility of the customer.



HELIOMA - Plásticos, S.A.

Zona Industrial
EN-1 / IC2 km 250,5
3850-184 Albergaria-a-Velha
Portugal

GPS
Lat: 40.716484°(N)
Lng: 8.48552° (W)

W: www.heliroma.pt
E: comercial@heliroma.pt
T: + 351 234 523 373
 [Heliroma.Plasticos](https://www.facebook.com/Heliroma.Plasticos)
 [heliroma-plásticos](https://www.linkedin.com/company/heliroma-plasticos)



HULIOT
GROUP